



*konusulan kalite...  
the spoken quality...  
qualität über die man spricht...*

**2022** KATALOĞU  
CATALOGUE  
KATALOG

*Kesici Uç ve Bağlama Sistemleri  
Cutting Inserts and Connection Systems  
Trägerwerkzeuge für Wendeschneidplatten*



[www.akko.com.tr](http://www.akko.com.tr)

*konusulan*  
*the spoken kalite...*  
*quality...*







TS EN ISO 9001:2015





1986 yılında Abdullah KARAKUŞ tarafından kurulan AKKO Oto. Mak. Hırd. San. Tic. Ltd. Şti. Tornalama Takımları, Diş ve Kanal Açma Takımları, Delik Delme Takımları, Frezeleme Takımları ve talebe yönelik Özel Takımları üretmektedir. Şu an 39.000 m<sup>2</sup>' ye yakın bir alanda Türkiye, Japonya, Almanya, İsviçre gibi ülkelerin ürettikleri son teknoloji tezgah ve ekipmanlarıyla yıllık 400.000 adet üretim kapasitesiyle, standart 10.000 çeşit takım üretimi yapmaktadır. Avrupa, Asya, Afrika, Güney Amerika, Kuzey Amerika ve Orta Doğu kıtalarında şimdilik 90 ülkeye ürün sevkiyatına devam etmektedir. Minimum 300.000 adet üretilmiş ürün stoklarında mevcut bulunmaktadır. Firma için özel üretilen çelik hammadde işleme girer ve bütün üretim süreci kendi bünyesinde gerçekleşmektedir. Çeliğin işlenmesi, ısıl işlemi, üzerindeki kaplama ve her türlü üretim operasyonları bir entegre tesis olan AKKO'da yapılmaktadır.

We as AKKO Oto. Mak. Hırd. San. Tic. Ltd. Şti, which has been founded by Abdullah KARAKUŞ in 1986, produces Turning Tool Holders, Threading and Grooving Tool Holders, U-Drills, Milling Tool Holders, and Precision Tool Holders ( OEM Tool Holders ) on-demand. We produce standard 10.000 kinds of tool holders with a production capacity of 400.000 pieces per annum in an area of about 39.000 square meters. We are going on exporting to 90 countries including European, Asian, African, South American Countries, North American Countries, and Middle East Countries. We keep ready about 300.000 pieces produced products in our stock. Steel Raw materials that we make produced especially for us are delivered our factory and all production process are made in our factory. All kinds of operations from machining of steel to heat treatment and coating on our tools are made in our integrated factory AKKO.

Wir die Firma AKKO Oto. Mak. Hırd. San. Tic. Ltd. Şti, welches durch Herrn Abdullah Karakuş in 1986 gegründet wurde, produzieren Dreh-, Gewinde- und Stechwerkzeuge für Wendeschneidplatten. Ebenso gehören Wendeplattenbohrer, Wendeplattenfräser und Sonderwerkzeuge nach Anfrage für Wendeplatten zum Lieferprogramm. Alle Werkzeuge sind auch als OEM-Version lieferbar. Wir produzieren 10.000 standart Arten der Werkzeughalter mit einer Produktionskapazität von 400.000 Stücken per annum auf einer Fläche von 39.000 quadrat meter. Wir exportieren unsere eigenproduzierten Ware nach 90 Ländern, Europa, Asien, Afrika, Süd amerikanische Länder, Mittlerer Osten. Lieferbereit halten wir 300.000 Stück produzierte Produkte auf Lager. Das eingesetzte Rohmaterial wird speziell für unsere Firma produziert. Alle Produktionsschritte werden auf unseren eigenen Anlagen veranlasst. Alle einzellenen Produktionsschritte wie z.B. mechanische Bearbeitung, Wärmebehandlung und Beschichtung unserer Werkzeuge erfolgen auf unseren eigenen Maschinenanlagen.

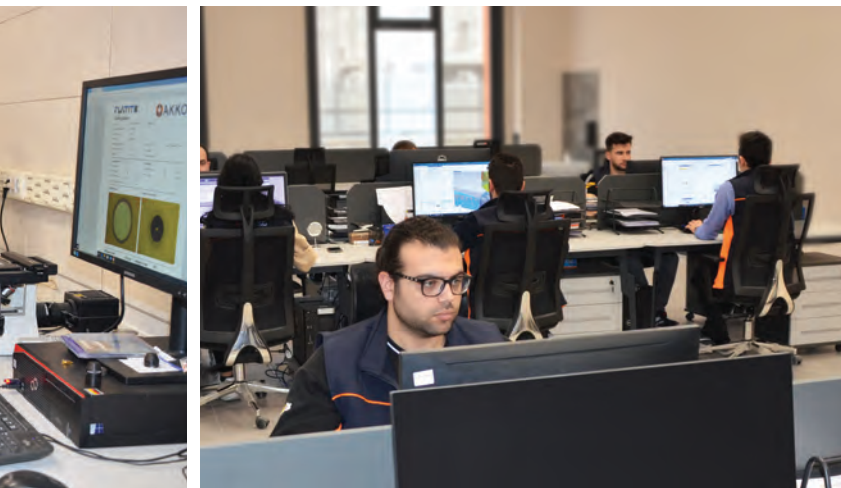

<b>DIŞ TORNA TAKIMLARI</b>	
S11 S12-S28 S29-S31 S32-S43 S44-S50 S51-S65 S66-S70 S70-S73	DIŞ TORNA KATERLERİ KODLAMA SİSTEMİ T-SİSTEM DIŞ TORNA KATERLERİ M-SİSTEM DIŞ TORNA KATERLERİ P-SİSTEM DIŞ TORNA KATERLERİ C-SİSTEM DIŞ TORNA KATERLERİ S-SİSTEM DIŞ TORNA KATERLERİ S-SİSTEM İSVİÇRE TİPİ KAYAR OTOMAT MAKİNA TAKIMLARI KOLAY DEĞİŞTİRİLEBİLİR İSVİÇRE TİPİ KAYAR OTOMAT MAKİNA TAKIMLARI
<b>DELİK TORNA TAKIMLARI</b>	
S75 S76-S82 S83-S87 S88-S94 S95-S112	DELİK TORNA KATERLERİ KODLAMA SİSTEMİ T&C SİSTEM DELİK TORNA KATERLERİ M-SİSTEM DELİK TORNA KATERLERİ P-SİSTEM DELİK TORNA KATERLERİ S-SİSTEM DELİK TORNA KATERLERİ
<b>TIRLAMAZ TAKIMLAR-ANTI VIBRATION TOOLS</b>	
S114 S115-S120	TIRLAMAZ TAKIMLARIN KODLAMA SİSTEMİ TIRLAMAZ TAKIMLAR
<b>KARTUŞLAR</b>	
S122 S123-S125 S125-S128 S128-S131	KARTUŞLARIN KODLAMA SİSTEMİ S-TİP RÊKTEFİYE KARTUŞLARI S-SİSTEM KARTUŞLAR P-SİSTEM KARTUŞLAR VE BORU PAHLAMA TAKIMLARI
<b>DIŞ AÇMA TAKIMLARI</b>	
S133 S134-S139	DIŞ AÇMA KATERLERİ KODLAMA SİSTEMİ DIŞ AÇMA KATERLERİ ve TEKNİK BİLGİ
<b>KANAL AÇMA TAKIMLARI</b>	
S141 S142-S157 S158-S161 S162-S165 S165 S166-S169 S170 S173-S183	KANAL KATERLERİ KODLAMA SİSTEMİ DIŞ ÇAP KANAL AÇMA TAKIMLARI DIŞ ÇAP KANAL AÇMA İSVEÇ TİPİ KAYAR OTOMAT MAKİNA TAKIMLARI DIŞ ÇAP ALIN KANAL AÇMA TAKIMLARI L TİP ALIN KANAL AÇMA TAKIMLARI KESME VE DERİN KANAL AÇMA LAMALARI KESME VE DERİN KANAL AÇMA LAMA BLOĞU DELİK İÇİ KANAL KATERLERİ
<b>DELİK DELME ve İŞLEME TAKIMLARI</b>	
S187-S216 S218-S219 S220 S221 S222-S224 S225-S234	TAKMA UÇLU MATKAPLAR ve KODLAMA SİSTEMİ DELİK PAHLAMA TAKIMI VE MONTAJ ŞEKLİ EKSANTRİK TAKMA UÇLU MATKAP ADAPTÖRÜ ÖZEL DELİK DELME ve İŞLEME TAKIMI SİPARİŞ FORMU EKONOMİK KEŞİCİLER ve KODLAMA SİSTEMİ AYARLI DELİK İŞLEME BARALARI ve KODLAMA SİSTEMİ
<b>FREZELEME TAKIMLARI</b>	
S236 S237-S238 S238 S239 S240-S266 S267-S270 S270-S281 S281-S293 S293-S303 S304-S305 S306-S307 S308 S308-S310 S310-S311 S312-S351 S352-S356 S357-S359 S360-S368 S369-S370 S371-S372 S374-S378	FREZELEME TAKIMLARI KODLAMA SİSTEMİ S-SİSTEM PAH FREZELER HELİS PAH FREZELEME TAKIMLARI SİLİNDİRİK ALYAN BAŞLI VİDA (DIN 974-1) HAVŞALARINI AÇMA FREZELERİ S-SİSTEM YÜZEY PARMAK FREZELER S-SİSTEM YÜZEY ve KOPYA PARMAK FREZELER S-SİSTEM HIZLI İLERLEMELİ PARMAK FREZELER S-SİSTEM MODÜLER PARMAK FREZELER S-SİSTEM HIZLI İLERLEMELİ MODÜLER PARMAK FREZELER KÜRE UÇLU PARMAK FREZELER MODÜLER KÜRE UÇLU PARMAK FREZELER VIDALI TAKIM TUTUCULARI DIŞ AÇMA FREZELEME TAKIMLARI S-SİSTEM HELİS FREZELER YÜZEY FREZELER YÜZEY ve KOPYA FREZELER C-SİSTEM YÜZEY FREZELER HIZLI İLERLEMELİ FREZELER T KANAL FREZELER DİSK FREZELER FREZELEME TAKIMLARI MONTAJ ÖLÇÜLERİ ve TEKNİK BİLGİLER
<b>YEDEK PARÇALAR</b>	
S380-S393 S394-S399	YEDEK PARÇALAR ÜRÜN GURUPLARINA GÖRE İÇİNDEKİLER

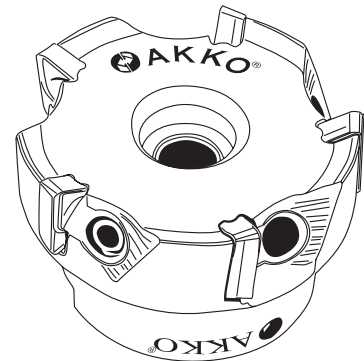
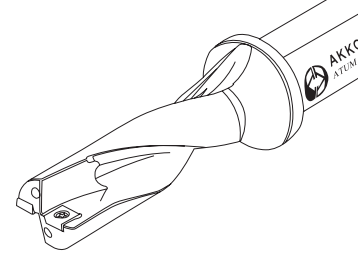
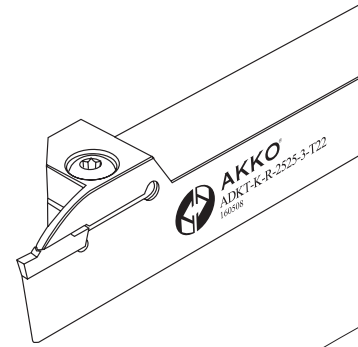
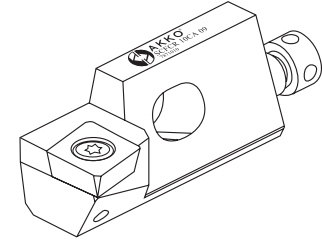
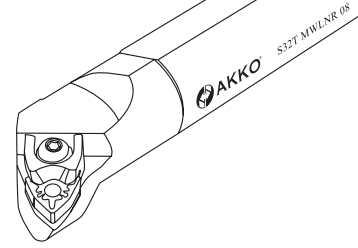
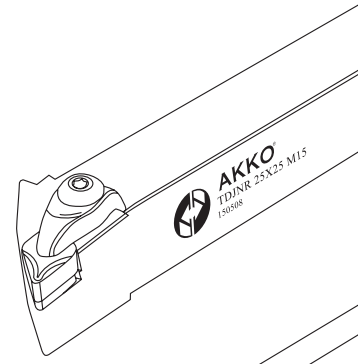

# CONTENTS

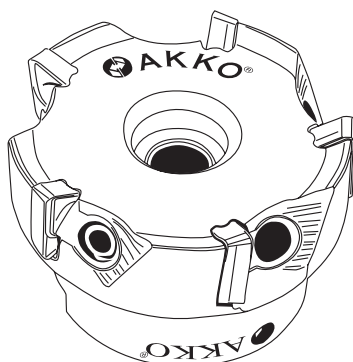
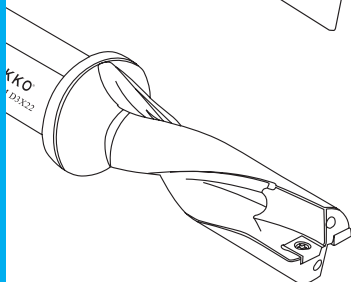
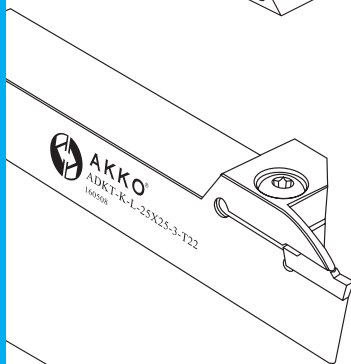
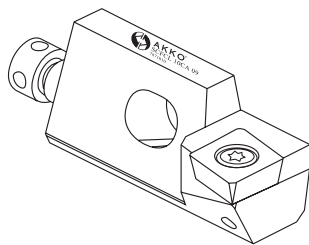
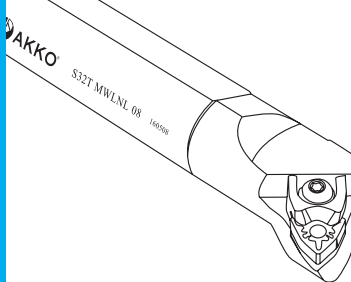
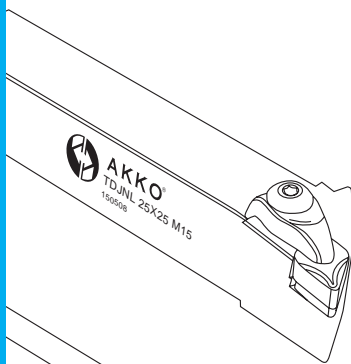

## EXTERNAL TURNING TOOLHOLDERS

EXTERNAL TURNING TOOLHOLDERS DESIGNATION SYSTEM  
 T-SYSTEM EXTERNAL TURNING TOOLHOLDERS  
 M-SYSTEM EXTERNAL TURNING TOOLHOLDERS  
 P-SYSTEM EXTERNAL TURNING TOOLHOLDERS  
 C-SYSTEM EXTERNAL TURNING TOOLHOLDERS  
 S-SYSTEM EXTERNAL TURNING TOOLHOLDERS  
 S-SYSTEM TOOLS FOR SWISS TYPE SLIDING AUTOMATIC LATHES  
 SEC TOOLS - SWISS EASY CHANGE

P11  
 P12-P28  
 P29-P31  
 P32-P43  
 P44-P50  
 P51-P65  
 P66-P70  
 P70-P73

## INTERNAL TURNING TOOLHOLDERS

BORING BARS DESIGNATION SYSTEM  
 T&C SYSTEM BORING BARS  
 M-SYSTEM BORING BARS  
 P-SYSTEM BORING BARS  
 S-SYSTEM BORING BARS

P75  
 P76-P82  
 P83-P87  
 P88-P94  
 P95-P112

## ANTIVIBRATION TOOLS

ANTIVIBRATION TOOL DESIGNATION SYSTEM  
 ANTIVIBRATION TOOLS

P114  
 P115-P120

## CARTRIDGE

CARTRIDGE DESIGNATION SYSTEM  
 S-TYPE ENGINE OVERHAUL CARTRIDGE  
 S-SYSTEM CARTRIDGE  
 P-SYSTEM CARTRIDGE AND PIPE BEVELING and CHAMFERING TOOLS

P122  
 P123-P125  
 P125-P128  
 P128-P131

## THREADING TOOLHOLDERS

THREADING TOOLHOLDERS DESIGNATION SYSTEM  
 THREADING TOOLHOLDERS and TECHNICAL INFORMATION

P133  
 P134-P139

## GROOVING TOOLHOLDERS

GROOVING TOOLHOLDERS DESIGNATION SYSTEM  
 EXTERNAL GROOVING TOOLHOLDERS  
 EXTERNAL GROOVING TOOLHOLDERS FOR SWISS TYPE SLIDING AUTOMATIC LATHES  
 FACE EXTERNAL GROOVING TOOLHOLDERS  
 L TYPE FACE EXTERNAL GROOVING TOOLHOLDERS  
 BLADES FOR PARTING AND DEEP GROOVING  
 BLOCKS FOR PARTING AND DEEP GROOVING BLADES  
 INTERNAL GROOVING TOOLHOLDERS

P141  
 P142-P157  
 P158-P161  
 P162-P165  
 P165  
 P166-P169  
 P170  
 P173-P183

## DRILLING and HOLEMAKING TOOLS

U-DRILL SYSTEM and DESIGNATION SYSTEM  
 DRILL CHAMFERING RING TOOLS and MOUNTING SYSTEM  
 EXCENTRIC ADAPTOR FOR U-DRILLS  
 SPECIAL DRILL ORDER FORM  
 ECONOMIC CUTTING TOOLS and DESIGNATION SYSTEM  
 ADJUSTABLE BORING HEADS and DESIGNATION SYSTEM

P187-P216  
 P218-P219  
 P220  
 P221  
 P222-P224  
 P225-P234

## MILLING TOOLS

MILLING TOOLS DESIGNATION SYSTEM  
 S-SYSTEM CHAMFERING END MILLS  
 HELIX CHAMFER MILLING TOOLS  
 COUNTERSINK MILLING TOOL FOR CYLINDRICAL ALLEN HEAD SCREWS (DIN 974-1)  
 S-SYSTEM END MILLS  
 S-SYSTEM FACE and COPY END MILLS  
 S-SYSTEM HIGHFEED END MILLS  
 S-SYSTEM MODULAR END MILLS (SCREW TYPE TOOLS)  
 S-SYSTEM MODULAR (SCREW TYPE) HIGHFEED END MILLS  
 BALL NOSE MILLS  
 BALL NOSE MODULAR (SCREW TYPE) END MILLS  
 SCREWED TOOL HOLDERS  
 THREAD MILLING TOOLS  
 S-SYSTEM HELIX END MILL  
 FACE MILLING  
 FACE and COPY MILLING TOOLS  
 C-SYSTEM FACE MILLING  
 HIGH FEED MILLING TOOLS  
 T SLOT MILLING  
 DISC MILLING  
 MOUNTING REFERENCE FOR MILLING CUTTERS and TECHNICAL INFORMATION

P236  
 P237-P238  
 P238  
 P239  
 P240-P266  
 P267-P270  
 P270-P281  
 P281-P293  
 P293-P303  
 P304-P305  
 P306-P307  
 P308  
 P308-P310  
 P310-P311  
 P312-P351  
 P352-P356  
 P357-P359  
 P360-P368  
 P369-P370  
 P371-P372  
 P374-P378

## SPARE PARTS

SPARE PARTS  
 INDEX

P380-P393  
 P394-P399

<b>DREHEN - AUßENDREHHALTER</b>	
P11	BEZEICHNUNGSSCHLÜSSEL FÜR DREHALTER AUßENBEARBEITUNG
P12-P28	T-SYSTEM AUSSEN - DREHHALTER
P29-P31	M-SYSTEM AUSSEN - DREHHALTER
P32-P43	P SYSTEM AUSSEN - DREHHALTER
P44-P50	C SYSTEM AUSSEN - DREHHALTER
P51-P65	S SYSTEM AUSSEN - DREHHALTER
P66-P70	S-SYSTEM FÜR LANGDREHAUTOMATEN
P70-P73	SEC TOOLS
<b>DREHWERKZEUGE FÜR DIE INNENBEARBEITUNG</b>	
P75	BOHRSTANGE BEZEICHNUNGSSYSTEM
P76-P82	T&C SYSTEM BOHRSTANGE
P83-P87	M-SYSTEM BOHRSTANGE
P88-P94	P- SYSTEM BOHRSTANGE
P95-P112	S- SYSTEM BOHRSTANGE
<b>ANTIVIBRATION TOOLS</b>	
P114	ANTIVIBRATION TOOL DESIGNATION SYSTEM
P115-P120	ANTIVIBRATION TOOLS
<b>KURZDREHHALTER</b>	
P122	KURZDREHHALTER BEZEICHNUNGSSYSTEM
P123-P125	S-SYSTEM KURZDREHHALTER FÜR DIE MOTORINSTANDHALTUNG
P125-P128	S-SYSTEM KURZDREHHALTER
P128-P131	S-SYSTEM KURZDREHHALTER
<b>GEWINDE DREHHALTER</b>	
P133	GEWINDE DREHHALTER BEZEICHNUNGSSYSTEM
P134-P139	AUSSEN-GEWINDEDREHHALTER
<b>STECHHALTER</b>	
P141	STECHHALTER BEZEICHNUNGSSYSTEM
P142-P157	AUßEN-STECHHALTER
P158-P161	WERKZEUGE ZUR STECHBEARBEITUNG AUF LANGDREHAUTOMATEN
P162-P165	AXIAL-STECHHALTER
P165	AXIAL STECHHALTER L-TYPE
P166-P169	STECHSCHWERT FÜR ABSTECHEN UND TIEFE EINSTICHE
P170	SPANNBLOCK FÜR STECHSCHWERT
P173-P183	INNEN-STECHHALTER
<b>BOHRWERKZEUGE</b>	
P187-P216	VOLLBOHRER / BEZEICHNUNGSSYSTEM FÜR VOLLBOHRER
P218-P219	FASRING FÜR VOLLBOHRER
P220	EXENTRISCHER ADAPTER FÜR WENDEPLATTENBOHRER
P221	BESTELLFORMULAR FÜR SONDERBOHRER
P222-P224	BEZEICHNUNGSSYSTEM FÜR MULTIFUNKTIONALES DREH-UND BOHRWERKZEUG / BOHREN, INNEN-UND AUßENDREHEN
P225-P234	BEZEICHNUNGSSYSTEM FÜR EINSTELLBARE SPINDELKÖPFE / EINSTELLBARE SPINDELKÖPFE
<b>FRÄSWERKZEUGE</b>	
P236	BEZEICHNUNGSSYSTEM FÜR FRÄSER
P237-P238	S-SYSTEM FASFRÄSER
P238	HELIX-FASFRÄSER
P239	SENKWERKZEUG FÜR ZYLINDERKOPFSCHRAUBEN (DIN 974-1)
P240-P266	S-SYSTEM SCHAFTFRÄSER
P267-P270	S-SYSTEM KOPIER- UND SCHAFTFRÄSER
P270-P281	S-SYSTEM HOCHVORSCHUB- SCHAFTFRÄSER
P281-P293	S-SYSTEM EINSCHRAUBFRÄSER
P293-P303	S-SYSTEM HOCHVORSCHUB-EINSCHRAUBFRÄSER
P304-P305	KUGELKOPIERFRÄSER
P306-P307	MODULARE EINSCHRAUB-KUGELFRÄSER
P308	AUFNAHME FÜR EINSCHRAUBFRÄSER
P308-P310	GEWINDEFÄSERWERKZEUGE
P310-P311	S-SYSTEM WENDELSCHAFTFRÄSER
P312-P351	PLAN UND ECKMESSERKÖPFE
P352-P356	MESSERKÖPFE FÜR RUNDE WENDESCHNEIDPLATTEN
P357-P359	PLAN UND ECKMESSERKÖPFE
P360-P368	HOCHVORSCHUBFRÄSER
P369-P370	T-NUTENFRÄSER
P371-P372	SCHEIBENFRÄSER
P374-P378	ABMESSUNGEN DER AUFNAHMEBOHRUNGEN FÜR MESSERKÖPFE
<b>ERSATZTEILE</b>	
P380-P393	ERSATZTEILE
P394-P399	INDEX

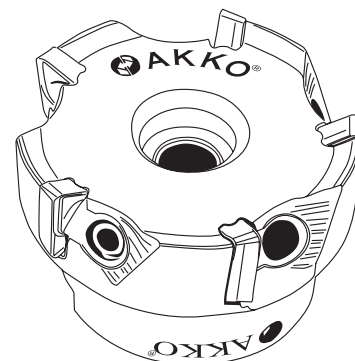
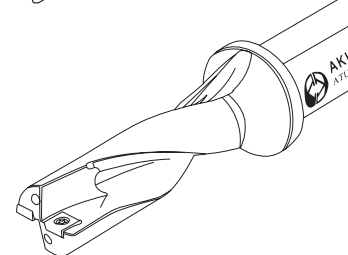
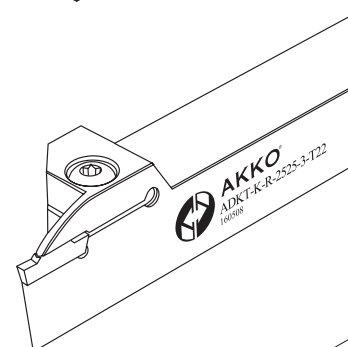
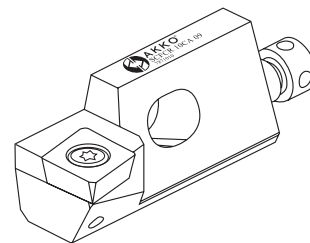
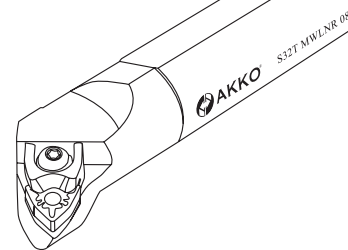
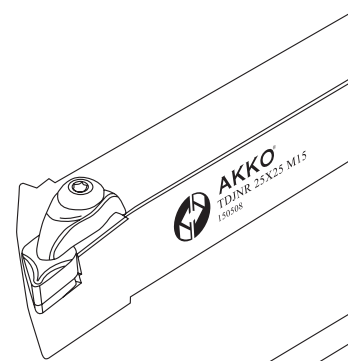



**konusulan**  
**the spoken kalite...**  
**quality...**





**DIŞ TORNA TAKIMLARI**  
*EXTERNAL TURNING TOOLHOLDERS*  
*DREHEN - AUßENDREHHALTER*





**P** **S** **K** **N** **R**

1 2 3 4 5

**1** Sıkma Tipi / Method of Mounting of Insert / Klemmsystem

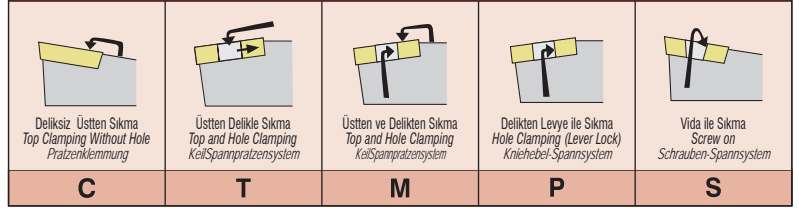

**2** Uç Tipi / Type of Insert / Plattenform

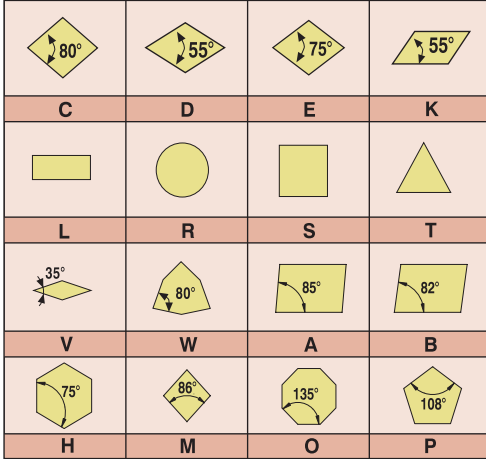

**3** Yanaşma Açısı / Tool Holder Shape Bar Geometry / Anstellwinkel

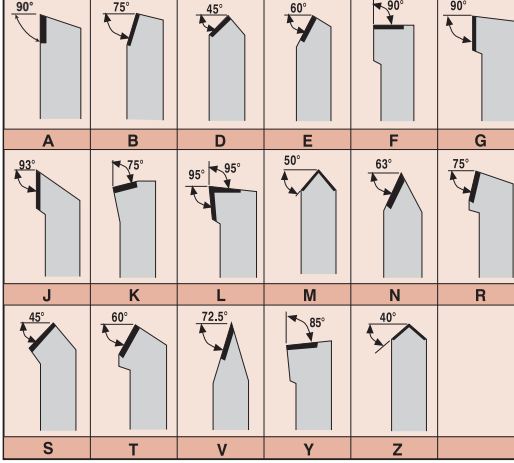

**4** Serbest Uç Açısı / Insert Clearance Angle / Freiwinkel / Freiwinkel

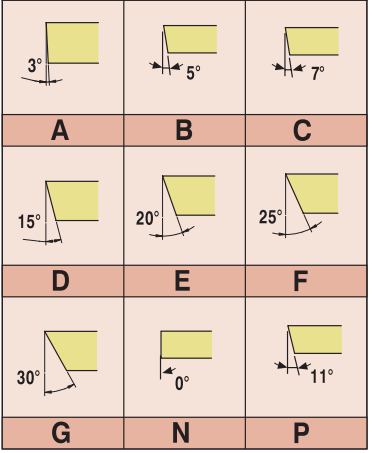

**25** **25** - **M** **12** **C**

6 7 8 9 10

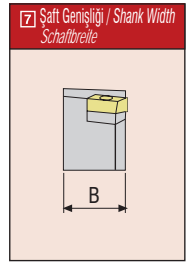
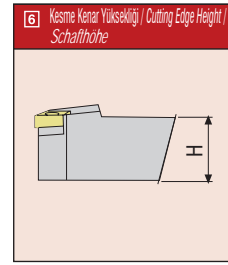
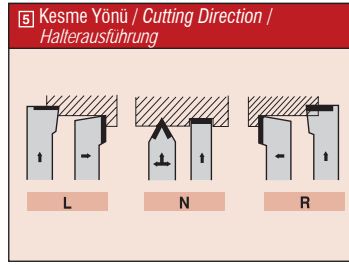

**8** Şaft Boyu / Shank Length / Schaftlänge

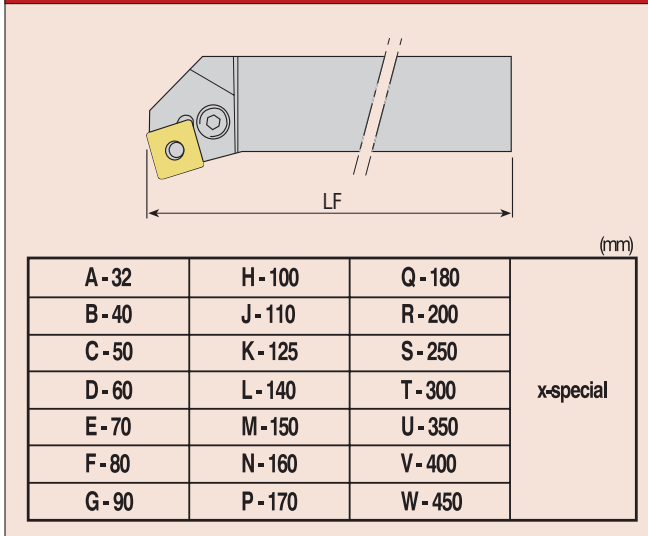

**9** Kesme Kenar Uzunluğu / Cutting Edge Length / Schneidkantenlänge

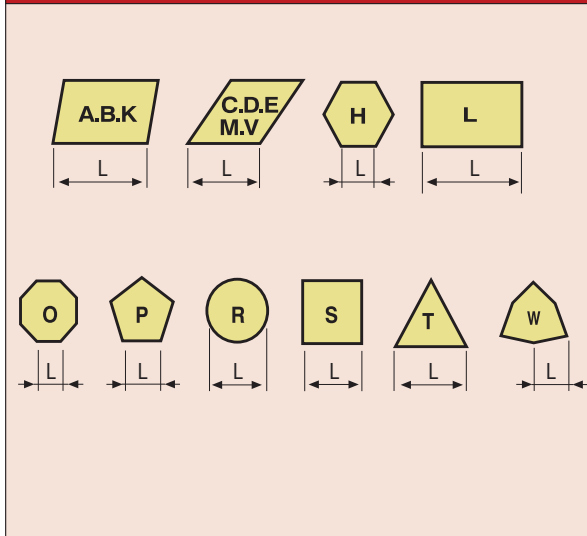

**10** Baskı Pabucu / Wedge Clamp / Spannpratze

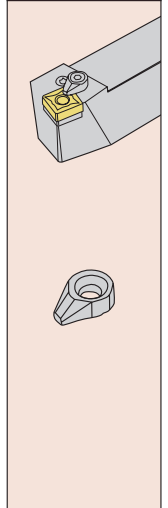



*konusulan  
the spoken kalite...  
quality...*

# T-SİSTEM

**T-SİSTEM DIŞ TORNA KATERLERİ**

**T-SYSTEM EXTERNAL TURNING TOOLHOLDERS**

**T-SYSTEM AUSSEN - DREHHALTER MIT INNENKÜHLUNG**



**DETAYLI BİLGİ İÇİN BARKODU OKUTUNUZ**

SCAN ME FOR MORE DETAILS

FÜR DETAILS BITTE DEN QR CODE SCANNEN

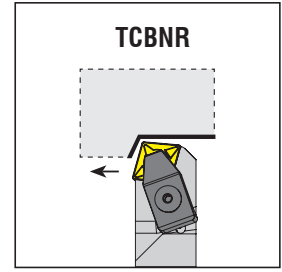
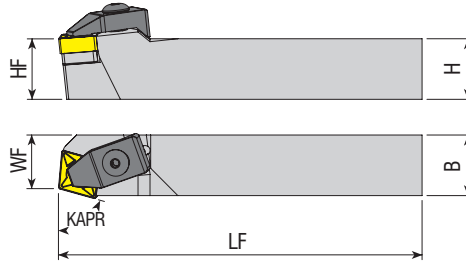

Takım Kodu Ordering Code Bestell-Bezeichnung	Stok Stock Lager		Takım Ölçüleri (mm) Dimension (mm) Abmessung (mm)				Kesici Uç Insert Wendeschneidplatte	Yedek Parçaları / Spare Parts / Ersatzteile								
	R	L	HF=H	B	LF	WF		Baskı Pabucu Wedge Clamp Spannpratze	Pabuç Vidası Clamp Screw Klemmschraube	Altlık Shim Unterlage	Altlık Vidası Shim Screw Schraube für Unterlage	Segman Ring Feder	Pul Stamp Ring	Anahtar Allen Key Innerschraubenschlüssel		
	●	○														
TCBNR/L 2525 M16	●	○	25	25	150	22										
							<b>CNM. 1606..</b>	ATK-04	AKV-19-M7x25	AACN-3-0002	AAV-05-M6x15	AS-02	ABPL-02	AAL-05-4		

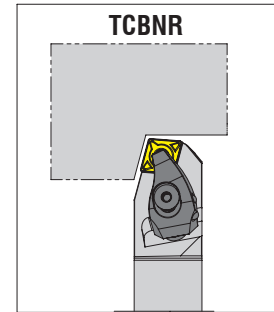
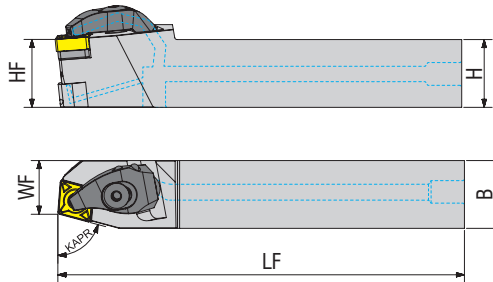

Takım Kodu Ordering Code Bestell-Bezeichnung	Stok Stock Lager		Takım Ölçüleri (mm) Dimension (mm) Abmessung (mm)				Kesici Uç Insert Wendeschneidplatte	Yedek Parçaları / Spare Parts / Ersatzteile								
	R	L	HF=H	B	LF	WF		Baskı Pabucu Wedge Clamp Spannpratze	Pabuç Vidası Clamp Screw Klemmschraube	Altlık Shim Unterlage	Altlık Vidası Shim Screw Schraube für Unterlage	Yay Spring Feder	Oring Ring Feder	Sızdırmaz Vida Threaded Pin Резьбовой Винт	Anahtar Allen Key Innerschraubenschlüssel	
	●	○														
TCBNR/L 2020 K12-H	○	○	20	20	125	16										
2525 M12-H	○	○	25	25	150	20	<b>CNM. 1204..</b>	ATKH-01-R	AKV-33-M6x22	AACN-3-0001	AAV-02-M5x12	AKY-01	AXR-01	2705-G1/8x5.5	AAL-03-3	
3232 P12-H	○	○	32	32	170	25		ATKH-02-L								

R: Sağ / Right / Rechts L: Sol / Left / Links

● Stokta / In Stock / Auf Lager ○ Stokta Yok / Non Stock Item / Kein Lagerartikel, Lieferzeit auf Anfrage

Sipariş Örneği/Ordering Example/Bestellbeispiel

1 ad./pcs./stück TCBNR/L 2525 M16

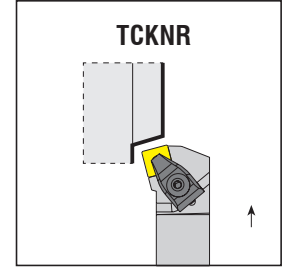
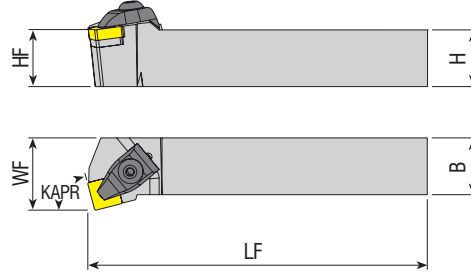

Takım Kodu Ordering Code Bestell-Bezeichnung	Stok Stock Lager		Takım Ölçüleri (mm) Dimension (mm) Abmessung (mm)				Kesici Uç Insert Wendeschneidplatte	Yedek Parçaları / Spare Parts / Ersatzteile						
	R	L	HF=H	B	LF	WF		Baskı Pabucu Wedge Clamp Spannpratze	Pabuç Vidası Clamp Screw Klemmschraube	Altlık Shim Unterlage	Altlık Vidası Shim Screw Schraube für Unterlage	Segman Ring Feder	Pul Stamp Ring	Anahtar Allen Key Innensechskantschlüssel
TCKNR/L 2020 K12	●	●	20	20	125	25	CNM. 1204..	ATK-02	AKV-30-M6x22	AACN-3-0001	AAV-02-M5x12	AS-01	ABPL-01	AAL-03-3
2525 M12	●	●	25	25	150	32								
3232 P12	●	●	32	32	170	40								
2525 M16	●	●	25	25	150	32	CNM. 1606..	ATK-04	AKV-19-M7x25	AACN-3-0002	AAV-05-M6x15	AS-02	ABPL-02	AAL-05-4
3232 P16	●	●	32	32	170	40								

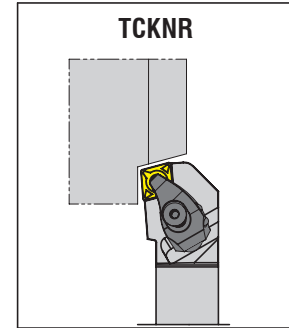
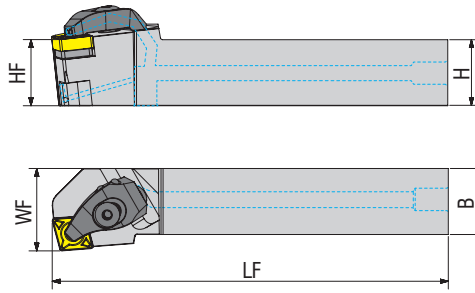

Takım Kodu Ordering Code Bestell-Bezeichnung	Stok Stock Lager		Takım Ölçüleri (mm) Dimension (mm) Abmessung (mm)				Kesici Uç Insert Wendeschneidplatte	Yedek Parçaları / Spare Parts / Ersatzteile							
	R	L	HF=H	B	LF	WF		Baskı Pabucu Wedge Clamp Spannpratze	Pabuç Vidası Clamp Screw Klemmschraube	Altlık Shim Unterlage	Altlık Vidası Shim Screw Schraube für Unterlage	Yay Spring Feder	Oring Ring Feder	Sızdırmaz Vida Threaded Pin Резьбовой Винт	Anahtar Allen Key Innensechskantschlüssel
TCKNR/L 2020 K12-H	○	○	20	20	125	25	CNM. 1204..	ATKH-01-R ATKH-02-L	AKV-33-M6x22	AACN-3-0001	AAV-13-M5x8	AKY-01	AXR-01	2705-G1/8x5.5	AAL-03-3
2525 M12-H	○	○	25	25	150	32									
3232 P12-H	○	○	32	32	170	40									

R: Sağ / Right / Rechts L: Sol / Left / Links

● Stokta / In Stock / Auf Lager ○ Stokta Yok / Non Stock Item / Kein Lagerartikel, Lieferzeit auf Anfrage

Sipariş Örneği/Ordering Example/Bestellbeispiel

1 ad./pcs./stück TCKNR 2020 K12

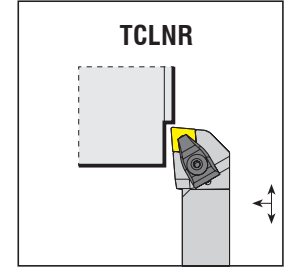
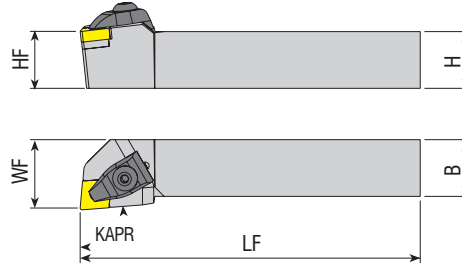

**Takım Kodu**  
**Ordering Code**  
**Bestell-Bezeichnung**

Takım Kodu Ordering Code Bestell-Bezeichnung	Stok Stock Lager		Takım Ölçüleri (mm) Dimension (mm) Abmessung (mm)				Kesici Uç Insert Wendeschneidplatte	Yedek Parçaları / Spare Parts / Ersatzteile							
	R	L	HF=H	B	LF	WF		Baskı Pabuçu Wedge Clamp Spannpratze	Pabuç Vidası Clamp Screw Klemmschraube	Altlık Shim Unterlage	Altlık Vidası Shim Screw Schraube für Unterlage	Segman Ring Feder	Pul Stamp Ring	Anahtar Allen Key Innensechskantschlüssel	
<b>TCLNR/L 2020 K12</b>	●	●	20	20	125	25	<b>CNM. 1204..</b>								
<b>2525 M12</b>	●	●	25	25	150	32									
<b>3232 P12</b>	●	●	32	32	170	40									
<b>4040 S12</b>	●	●	40	40	250	50									
<b>5050 S12</b>	●	●	50	50	250	63									
<b>2525 M16</b>	●	●	25	25	150	32	<b>CNM. 1606..</b>								
<b>3232 P16</b>	●	●	32	32	170	40									

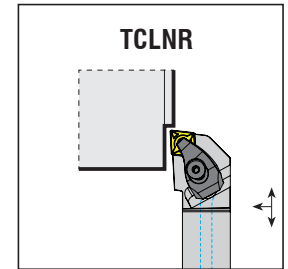
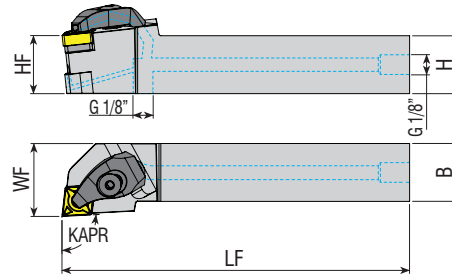

**Takım Kodu**  
**Ordering Code**  
**Bestell-Bezeichnung**

Takım Kodu Ordering Code Bestell-Bezeichnung	Stok Stock Lager		Takım Ölçüleri (mm) Dimension (mm) Abmessung (mm)				Kesici Uç Insert Wendeschneidplatte	Yedek Parçaları / Spare Parts / Ersatzteile							
	R	L	HF=H	B	LF	WF		Baskı Pabuçu Wedge Clamp Spannpratze	Pabuç Vidası Clamp Screw Klemmschraube	Altlık Shim Unterlage	Altlık Vidası Shim Screw Schraube für Unterlage	Yay Spring Feder	Oring Ring Feder	Sızdırmaz Vida Threaded Pin Резьбовой Винт	Anahtar Allen Key Innensechskantschlüssel
<b>TCLNR/L 2020 K12-H</b>	●	●	20	20	125	25	<b>CNM. 1204..</b>								
<b>2525 M12-H</b>	●	●	25	25	150	32									
<b>3232 P12-H</b>	●	●	32	32	170	40									

R: Sağ / Right / Rechts L: Sol / Left / Links

● Stokta / In Stock / Auf Lager ○ Stokta Yok / Non Stock Item / Kein Lagerartikel, Lieferzeit auf Anfrage

Sipariş Örneği/Ordering Example/Bestellbeispiel

1 ad./pcs./stück TCLNR 2020 K12

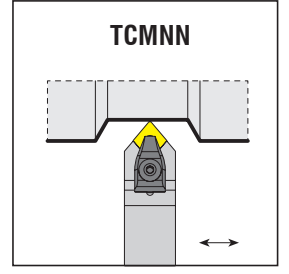
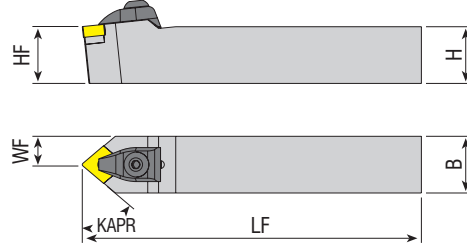

Takım Kodu Ordering Code Bestell-Bezeichnung	Stok Stock Lager	Takım Ölçüleri (mm) Dimension (mm) Abmessung (mm)				Kesici Uç Insert Wendeschneidplatte	Yedek Parçaları / Spare Parts / Ersatzteile							
		HF=H	B	LF	WF		Baskı Pabucu Wedge Clamp Spannpratze	Pabuç Vidası Clamp Screw Klemmschraube	Altlık Shim Unterlage	Altlık Vidası Shim Screw Schraube für Unterlage	Segman Ring Feder	Pul Stamp Ring	Anahtar Allen Key Innensechskantschlüssel	
<b>TCMNN 1616 H12</b>	●	16	16	100	8	<b>CNM. 1204..</b>	<b>ATK-02</b>	<b>AKV-30-M6x22</b>	<b>AACN-3-0001</b>	<b>AAV-02-M5x12</b>	<b>AS-01</b>	<b>ABPL-01</b>	<b>AAL-03-3</b>	
<b>2020 K12</b>	●	20	20	125	10									
<b>2525 M12</b>	●	25	25	150	12.5									
<b>3232 P12</b>	●	32	32	170	16									
<b>2525 M16</b>	●	25	25	150	12.5	<b>CNM. 1606..</b>	<b>ATK-04</b>	<b>AKV-19-M7x25</b>	<b>AACN-3-0002</b>	<b>AAV-05-M6x15</b>	<b>AS-02</b>	<b>ABPL-02</b>	<b>AAL-05-4</b>	
<b>3232 P16</b>	●	32	32	170	16									
<b>4040 S16</b>	○	40	40	250	20									

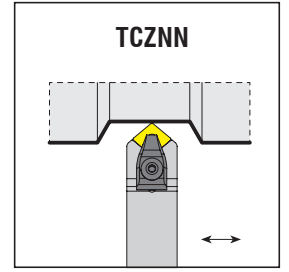
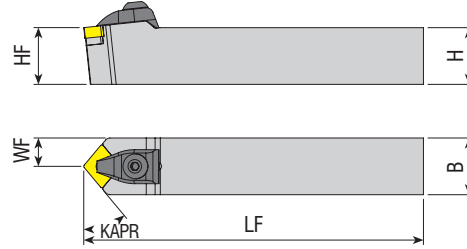

Takım Kodu Ordering Code Bestell-Bezeichnung	Stok Stock Lager	Takım Ölçüleri (mm) Dimension (mm) Abmessung (mm)				Kesici Uç Insert Wendeschneidplatte	Yedek Parçaları / Spare Parts / Ersatzteile							
		HF=H	B	LF	WF		Baskı Pabucu Wedge Clamp Spannpratze	Pabuç Vidası Clamp Screw Klemmschraube	Altlık Shim Unterlage	Altlık Vidası Shim Screw Schraube für Unterlage	Segman Ring Feder	Pul Stamp Ring	Anahtar Allen Key Innensechskantschlüssel	
<b>TCZNN 2020 K12</b>	●	20	20	125	10	<b>CNM. 1204..</b>	<b>ATK-02</b>	<b>AKV-30-M6x22</b>	<b>AACN-3-0001</b>	<b>AAV-02-M5x12</b>	<b>AS-01</b>	<b>ABPL-01</b>	<b>AAL-03-3</b>	
<b>2525 M12</b>	●	25	25	150	12.5									
<b>3232 P12</b>	●	32	32	170	16									
<b>2525 M16</b>	●	25	25	150	12.5									<b>CNM. 1606..</b>
<b>3232 P16</b>	●	32	32	170	16									

R: Sağ / Right / Rechts L: Sol / Left / Links

● Stokta / In Stock / Auf Lager ○ Stokta Yok / Non Stock Item / Kein Lagerartikel, Lieferzeit auf Anfrage

Sipariş Örneği/Ordering Example/Bestellbeispiel

1 ad./pcs./stück TCMNN 1616 H12



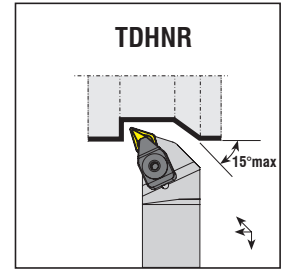
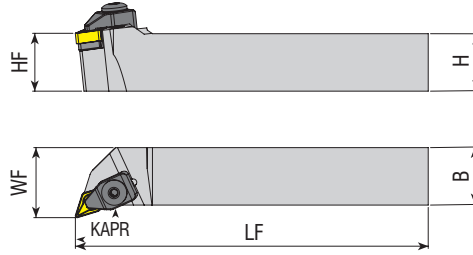

Takım Kodu Ordering Code Bestell-Bezeichnung	Stok Stock Lager		Takım Ölçüleri (mm) Dimension (mm) Abmessung (mm)				Kesici Uç Insert Wendeschneidplatte	Yedek Parçaları / Spare Parts / Ersatzteile						
	R	L	HF=H	B	LF	WF		Baskı Pabuçu Wedge Clamp Spannpratze	Pabuç Vidası Clamp Screw Klemmschraube	Altlık Shim Unterlage	Altlık Vidası Shim Screw Schraube für Unterlage	Segman Ring Feder	Pul Stamp Ring	Anahtar Allen Key Innensechskantschlüssel
	●	○												
<b>TDHNR/L 2525 M11</b>	○	●	25	25	150	31	<b>DNM. 1104..</b>	ATK-01	AKV-01-M5x22	AADN-2-0001	AAV-04-M5x12	-		
<b>2020 K15</b>	●	●	20	20	125	25								
<b>2525 M15</b>	●	●	25	25	150	32	<b>DNM. 1506..</b>	ATK-02	AKV-30-M6x22	AADN-3-0001	AAV-02-M5x12	AS-01	ABPL-01	AAL-03-3
<b>3232 P15</b>	●	●	32	32	170	40								

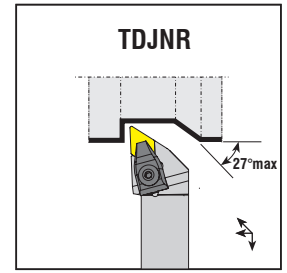
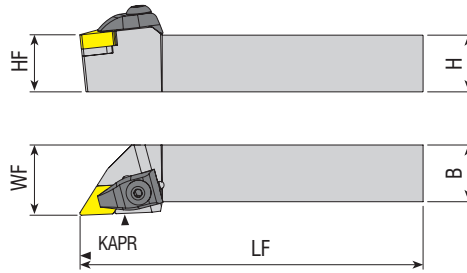

Takım Kodu Ordering Code Bestell-Bezeichnung	Stok Stock Lager		Takım Ölçüleri (mm) Dimension (mm) Abmessung (mm)				Kesici Uç Insert Wendeschneidplatte	Yedek Parçaları / Spare Parts / Ersatzteile						
	R	L	HF=H	B	LF	WF		Baskı Pabuçu Wedge Clamp Spannpratze	Pabuç Vidası Clamp Screw Klemmschraube	Altlık Shim Unterlage	Altlık Vidası Shim Screw Schraube für Unterlage	Segman Ring Feder	Pul Stamp Ring	Anahtar Allen Key Innensechskantschlüssel
	●	○												
<b>TDJNR/L 1616 H11</b>	●	●	16	16	100	20								
<b>2020 K11</b>	●	●	20	20	125	25	<b>DNM. 1104..</b>	ATK-01	AKV-01-M5x22	AADN-2-0001	AAV-04-M5x12	-		
<b>2525 M11</b>	●	●	25	25	150	32								
<b>2020 K15</b>	●	●	20	20	125	25								
<b>2525 M15</b>	●	●	25	25	150	32								
<b>3232 P15</b>	●	●	32	32	170	40	<b>DNM. 1506..</b>	ATK-02	AKV-30-M6x22	AADN-3-0001	AAV-02-M5x12	AS-01	ABPL-01	AAL-03-3
<b>4040 S15</b>	●	●	40	40	250	50								
<b>5050 S15</b>	○	○	50	50	250	63								
<b>2020 K1504</b>	●	●	20	20	125	25								
<b>2525 M1504</b>	●	●	25	25	150	32	<b>DNM. 1504..</b>	ATK-02	AKV-30-M6x22	AADN-2-0003	AAV-02-M5x12	AS-01		
<b>3232 P1504</b>	●	●	32	32	170	40								
<b>4040 S1504</b>	●	●	40	40	250	50								

R: Sağ / Right / Rechts L: Sol / Left / Links

● Stokta / In Stock / Auf Lager ○ Stokta Yok / Non Stock Item / Kein Lagerartikel, Lieferzeit auf Anfrage

Sipariş Örneği/Ordering Example/Bestellbeispiel  
1 ad./pcs./stück TDHNR 2525 M11

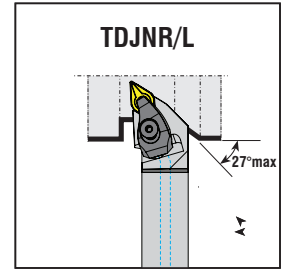
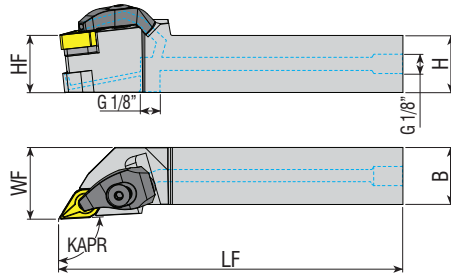

Takım Kodu Ordering Code Bestell-Bezeichnung	Stok Stock Lager		Takım Ölçüleri (mm) Dimension (mm) Abmessung (mm)				Kesici Uç Insert Wendeschneidplatte	Yedek Parçaları / Spare Parts / Ersatzteile								
	R	L	HF=H	B	LF	WF		Baskı Pabucu Wedge Clamp Spannpratze	Pabuç Vidası Clamp Screw Klemmschraube	Altılık Shim Unterlage	Altılık Vidası Shim Screw Schraube für Unterlage	Yay Spring Feder	Oring Ring Feder	Sızdırmaz Vida Threaded Pin Резьбовой Винт	Anahtar Allen Key Innenschlüssel	
<b>TDJNR/L 2020 K15-H</b>	●	●	20	20	125	25	<b>DNM. 1506..</b>									
<b>2525 M15-H</b>	●	●	25	25	150	32										
<b>3232 P15-H</b>	●	●	32	32	170	40										

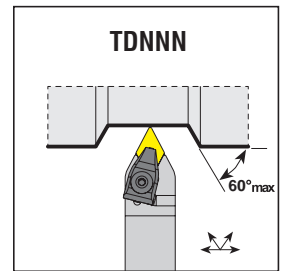
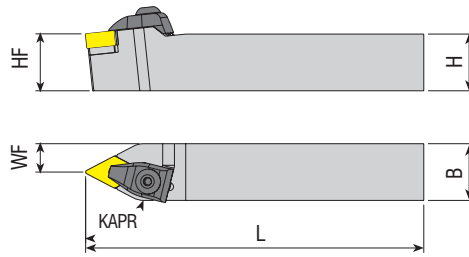
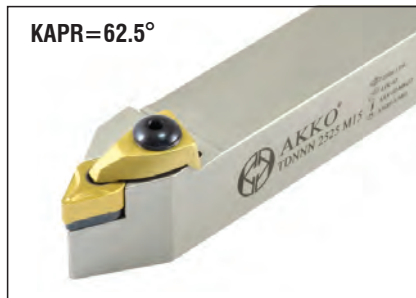

Takım Kodu Ordering Code Bestell-Bezeichnung	Stok Stock Lager	Takım Ölçüleri (mm) Dimension (mm) Abmessung (mm)				Kesici Uç Insert Wendeschneidplatte	Yedek Parçaları / Spare Parts / Ersatzteile								
		HF=H	B	LF	WF		Baskı Pabucu Wedge Clamp Spannpratze	Pabuç Vidası Clamp Screw Klemmschraube	Altılık Shim Unterlage	Altılık Vidası Shim Screw Schraube für Unterlage	Segman Ring Feder	Pul Stamp Ring	Anahtar Allen Key Innenschlüssel		
<b>TDNNN 1616 H11</b>	●	16	16	100	8	<b>DNM. 1104..</b>									
<b>2020 K11</b>	●	20	20	125	10										
<b>2525 M11</b>	●	25	25	150	12.5										
<b>2020 K15</b>	●	20	20	125	10	<b>DNM. 1506..</b>									
<b>2525 M15</b>	●	25	25	150	12.5										
<b>3232 P15</b>	●	32	32	170	16										
<b>4040 S15</b>	○	40	40	250	20										
<b>5050 S15</b>	○	50	50	250	25										

R: Sağ / Right / Rechts L: Sol / Left / Links

● Stokta / In Stock / Auf Lager ○ Stokta Yok / Non Stock Item / Kein Lagerartikel, Lieferzeit auf Anfrage

Sipariş Örneği/Ordering Example/Bestellbeispiel

1 ad./pcs./stück TDJNR 2020 K15-H

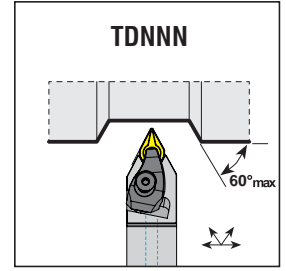
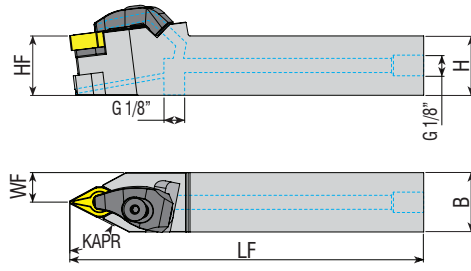

Takım Kodu Ordering Code Bestell-Bezeichnung	Stok Stock Lager	Takım Ölçüleri (mm) Dimension (mm) Abmessung (mm)				Kesici Uç Insert Wendeschneidplatte	Yedek Parçaları / Spare Parts / Ersatzteile								
		HF=H	B	LF	WF		Baskı Pabucu Wedge Clamp Spannpratze	Pabuç Vidası Clamp Screw Klemmschraube	Altlık Shim Unterlage	Altlık Vidası Shim Screw Schraube für Unterlage	Yay Spring Feder	Oring Ring Feder	Sızdırmaz Vidası Threaded Pin Резьбовой Винт	Anahtar Allen Key Innensechskantschlüssel	
<b>TDNN 2525 M15-H</b>	●	25	25	150	32										
						<b>DNM. 1506..</b>	ATKH-01-R ATKH-02-L	AKV-33-M6x22	AADN-3-0001	AAV-13-M5x8	AKY-01	AXR-01	2705-G1/8x5.5	AAL-03-3	

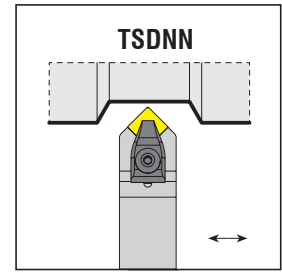
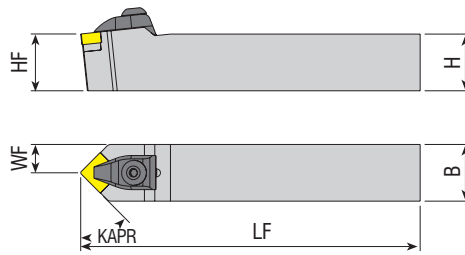

Takım Kodu Ordering Code Bestell-Bezeichnung	Stok Stock Lager	Takım Ölçüleri (mm) Dimension (mm) Abmessung (mm)				Kesici Uç Insert Wendeschneidplatte	Yedek Parçaları / Spare Parts / Ersatzteile								
		HF=H	B	LF	WF		Baskı Pabucu Wedge Clamp Spannpratze	Pabuç Vidası Clamp Screw Klemmschraube	Altlık Shim Unterlage	Altlık Vidası Shim Screw Schraube für Unterlage	Segman Ring Feder	Pul Stamp Ring	Anahtar Allen Key Innensechskantschlüssel		
<b>TSDNN 1616 H12</b>	●	16	16	100	8										
<b>2020 K12</b>	●	20	20	125	10	<b>SNM. 1204..</b>	ATK-02	AKV-30-M6x22	AASN-3-0004	AAV-02-M5x12	AS-01	ABPL-01	AAL-03-3		
<b>2525 M12</b>	●	25	25	150	12.5										
<b>3232 P12</b>	●	32	32	170	16										
<b>2525 M15</b>	○	25	25	150	12.5	<b>SNM. 1506..</b>	ATK-04	AKV-19-M7x25	AASN-3-0023	AAV-05-M6x15	AS-02	ABPL-02	AAL-05-4		
<b>3232 P15</b>	●	32	32	170	16										
<b>4040 S15</b>	○	40	40	250	20										

R: Sağ / Right / Rechts L: Sol / Left / Links

● Stokta / In Stock / Auf Lager ○ Stokta Yok / Non Stock Item / Kein Lagerartikel, Lieferzeit auf Anfrage

Sipariş Örneği/Ordering Example/Bestellbeispiel  
1 ad./pcs./stück TDNN 2525 M15-H

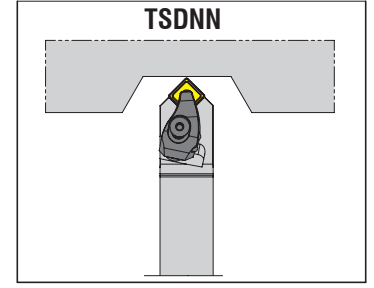
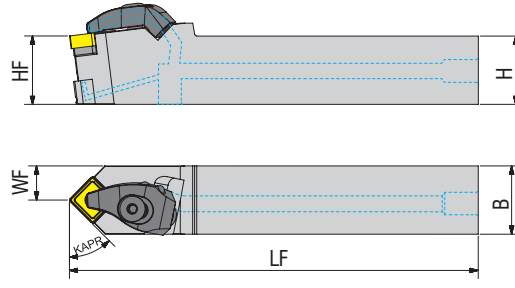

Takım Kodu Ordering Code Bestell-Bezeichnung	Stok Stock Lager		Takım Ölçüleri (mm) Dimension (mm) Abmessung (mm)				Kesici Uç Insert Wendeschneidplatte	Yedek Parçaları / Spare Parts / Ersatzteile									
	R	L	HF=H	B	LF	WF		Baskı Pabuçu Wedge Clamp Spannpratze	Pabuç Vidası Clamp Screw Klemmschraube	Altlık Shim Unterlage	Altlık Vidası Shim Screw Schraube für Unterlage	Yay Spring Feder	Oring Ring Feder	Sızdırmaz Vida Threaded Pin Резьбовой Винт	Anahtar Allen Key Innensechskantschlüssel		
<b>TSDNN 2525 M12-H</b>	●	○	25	25	150	25	SNM. 1204..	ATKH-01-R ATKH-02-L	AKV-33-M6x22	AASN-3-0004	AAV-02-M5x12			2705-G1/8x5.5	AAL-03-3		
<b>3232 P12-H</b>	●	○	32	32	170	16											
<b>2525 M15-H</b>	●	○	25	25	150	12.7	SNM. 1506..	ATKH-07-R ATKH-08-L	AKV-39-M7x21	AASN-3-0023	AAV-05-M6x10	AKY-01	AXR-01	2705-G1/8x5.5	AAL-05-4		
<b>3232 P15-H</b>	●	○	32	32	170	16											
<b>4040 S15-H</b>	●	○	40	40	250	20											

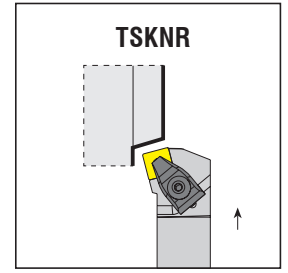
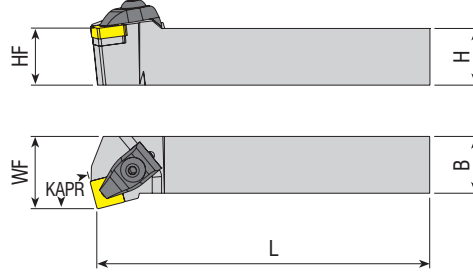

Takım Kodu Ordering Code Bestell-Bezeichnung	Stok Stock Lager		Takım Ölçüleri (mm) Dimension (mm) Abmessung (mm)				Kesici Uç Insert Wendeschneidplatte	Yedek Parçaları / Spare Parts / Ersatzteile									
	R	L	HF=H	B	LF	WF		Baskı Pabuçu Wedge Clamp Spannpratze	Pabuç Vidası Clamp Screw Klemmschraube	Altlık Shim Unterlage	Altlık Vidası Shim Screw Schraube für Unterlage	Segman Ring Feder	Pul Stamp Ring	Anahtar Allen Key Innensechskantschlüssel			
<b>TSKNR/L 2020 K12</b>	●	●	20	20	125	25	SNM. 1204..	ATK-02	AKV-30-M6x22	AASN-3-0004	AAV-02-M5x12	AS-01	ABPL-01	AAL-03-3			
<b>2525 M12</b>	●	●	25	25	150	32											
<b>3232 P12</b>	●	●	32	32	170	40											
<b>3232 P15</b>	●	●	32	32	170	40	SNM. 1506..	ATK-04	AKV-19-M7x25	AASN-3-0023	AAV-05-M6x15	AS-02	ABPL-02	AAL-05-4			

R: Sağ / Right / Rechts L: Sol / Left / Links  
● Stokta / In Stock / Auf Lager ○ Stokta Yok / Non Stock Item / Kein Lagerartikel, Lieferzeit auf Anfrage

Sipariş Örneği/Ordering Example/Bestellbeispiel  
1 ad./pcs./stück TSDNN 2525 M12-H

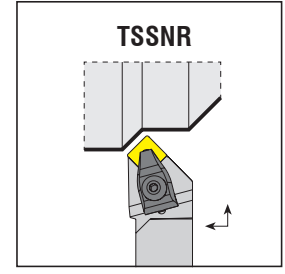
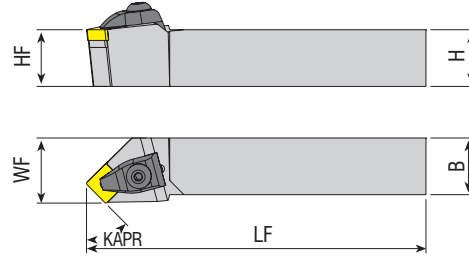

Takım Kodu Ordering Code Bestell-Bezeichnung	Stok Stock Lager		Takım Ölçüleri (mm) Dimension (mm) Abmessung (mm)				Kesici Uç Insert Wendeschneidplatte	Yedek Parçaları / Spare Parts / Ersatzteile													
	R	L	HF=H	B	LF	WF		Baskı Pabuçu Wedge Clamp Spannpratze	Pabuç Vidası Clamp Screw Klemmschraube	Altlık Shim Unterlage	Altlık Vidası Shim Screw Schraube für Unterlage	Segman Ring Feder	Pul Stamp Ring	Anahtar Allen Key Innensechskantschlüssel							
TSSNR/L 2020 K12	●	●	20	20	125	25	SNM. 1204..														
2525 M12	●	●	25	25	150	32									ATK-02	AKV-30-M6x22	AASN-3-0004	AAV-02-M5x12	AS-01	ABPL-01	AAL-03-3
3232 P12	●	●	32	32	170	40															
2525 M15	●	●	25	25	150	32	SNM. 1506..														
3232 P15	●	●	32	32	170	40									ATK-04	AKV-19-M7x25	AASN-3-0023	AAV-05-M6x15	AS-02	ABPL-02	AAL-05-4

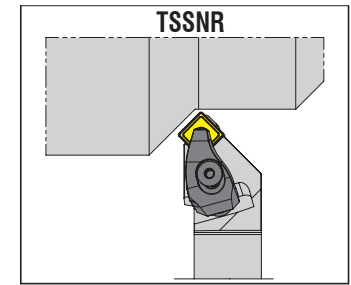
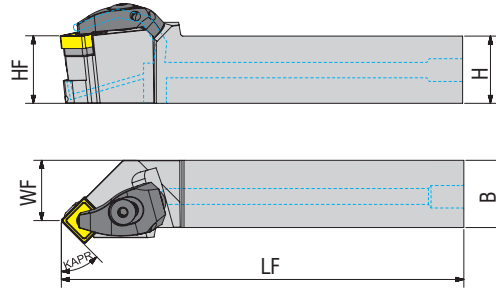

Takım Kodu Ordering Code Bestell-Bezeichnung	Stok Stock Lager		Takım Ölçüleri (mm) Dimension (mm) Abmessung (mm)				Kesici Uç Insert Wendeschneidplatte	Yedek Parçaları / Spare Parts / Ersatzteile															
	R	L	HF=H	B	LF	WF		Baskı Pabuçu Wedge Clamp Spannpratze	Pabuç Vidası Clamp Screw Klemmschraube	Altlık Shim Unterlage	Altlık Vidası Shim Screw Schraube für Unterlage	Yay Spring Feder	Oring Ring Feder	Sızdırmaz Vida Threaded Pin Резьбовой Винт	Anahtar Allen Key Innensechskantschlüssel								
TSSNR/L 2525 M12-H	○	○	25	25	150	32	SNM. 1204..																
3232 P12-H	○	○	32	32	170	32										ATKH-01-R ATKH-02-L	AKV-33-M6x22	AASN-3-0004	AAV-02-M5x12				AAL-03-3
2525 M15-H	○	○	25	25	150	40	SNM. 1506..																
3232 P15-H	○	○	32	32	170	40										ATKH-07-R ATKH-08-L	AKV-39-M7x21	AASN-3-0023	AAV-05-M6x10	AKY-01	AXR-01	2705-G1/8x5.5	AAL-05-4
4040 S15-H	○	○	40	40	250	50																	

R: Sağ / Right / Rechts L: Sol / Left / Links  
● Stokta / In Stock / Auf Lager ○ Stokta Yok / Non Stock Item / Kein Lagerartikel, Lieferzeit auf Anfrage

Sipariş Örneği/Ordering Example/Bestellbeispiel  
1 ad./pcs./stück TSSNR 2020 K12

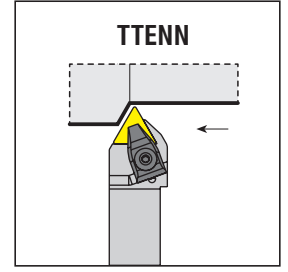
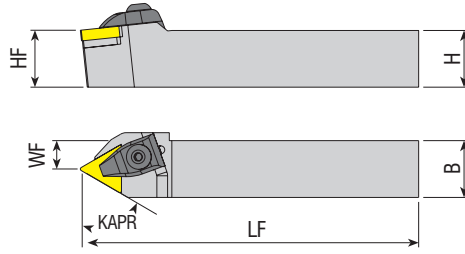

Takım Kodu Ordering Code Bestell-Bezeichnung	Stok Stock Lager		Takım Ölçüleri (mm) Dimension (mm) Abmessung (mm)				Kesici Uç Insert Wendeschneidplatte	Baskı Pabucu Wedge Clamp Spannpratze	Pabuç Vidası Clamp Screw Klemmschraube	Altlık Shim Unterlage	Altlık Vidası Shim Screw Schraube für Unterlage	Segman Ring Feder	Pul Stamp Ring	Anahtar Allen Key Innensechskantschlüssel
	HF=H	B	LF	WF	HF=H	B								
<b>TTENN 2020 K16</b>	●		20	20	125	10	TNM. 1604..	ATK-01	AKV-01-M5x22	AATN-2-0002	AAV-03-M5x12	-	ABPL-01	AAL-03-3
<b>2525 M16</b>	●		25	25	150	12.5								
<b>3232 P16</b>	●		32	32	170	16								
<b>2525 M22</b>	●		25	25	150	12.5	TNM. 2204..	ATK-02	AKV-30-M6x22	AATN-3-0015	AAV-02-M5x12	AS-01	ABPL-01	AAL-03-3
<b>3232 P22</b>	●		32	32	170	16								
<b>4040 S22</b>	○		40	40	250	20								

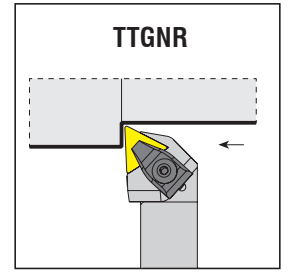
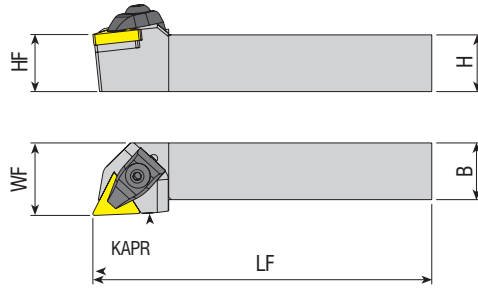
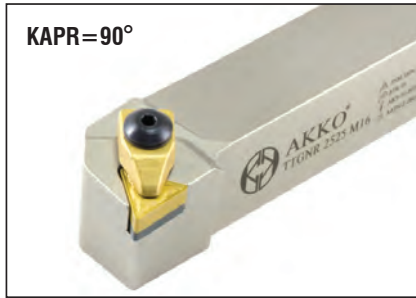

Takım Kodu Ordering Code Bestell-Bezeichnung	Stok Stock Lager		Takım Ölçüleri (mm) Dimension (mm) Abmessung (mm)				Kesici Uç Insert Wendeschneidplatte	Baskı Pabucu Wedge Clamp Spannpratze	Pabuç Vidası Clamp Screw Klemmschraube	Altlık Shim Unterlage	Altlık Vidası Shim Screw Schraube für Unterlage	Segman Ring Feder	Pul Stamp Ring	Anahtar Allen Key Innensechskantschlüssel
	R	L	HF=H	B	LF	WF								
<b>TTGNR/L 2020 K16</b>	●	●	20	20	125	25	TNM. 1604..	ATK-01	AKV-01-M5x22	AATN-2-0002	AAV-03-M5x12	-	ABPL-01	AAL-03-3
<b>2525 M16</b>	●	●	25	25	150	32								
<b>3232 P16</b>	●	●	32	32	170	40								
<b>2525 M22</b>	●	●	25	25	150	32	TNM. 2204..	ATK-02	AKV-30-M6x22	AATN-3-0015	AAV-02-M5x12	AS-01	ABPL-01	AAL-03-3
<b>3232 P22</b>	●	●	32	32	170	40								
<b>4040 S22</b>	●	○	40	40	250	50								

R: Sağ / Right / Rechts L: Sol / Left / Links

● Stokta / In Stock / Auf Lager ○ Stokta Yok / Non Stock Item / Kein Lagerartikel, Lieferzeit auf Anfrage

Sipariş Örneği/Ordering Example/Bestellbeispiel

1 ad./pcs./stück TTENN 2020 K16

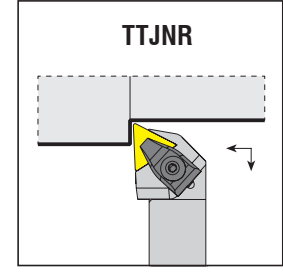
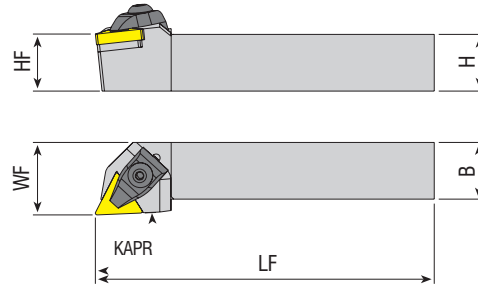
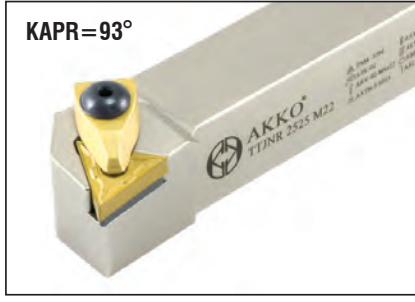

Takım Kodu Ordering Code Bestell-Bezeichnung	Stok Stock Lager		Takım Ölçüleri (mm) Dimension (mm) Abmessung (mm)				Kesici Uç Insert Wendeschneidplatte	Yedek Parçaları / Spare Parts / Ersatzteile							
	R	L	HF=H	B	LF	WF		Baskı Pabucu Wedge Clamp Spannpratze	Pabuç Vidası Clamp Screw Klemmschraube	Altlık Shim Unterlage	Altlık Vidası Shim Screw Schraube für Unterlage	Segman Ring Feder	Pul Stamp Ring	Anahtar Allen Key Innensechskantschlüssel	
TTJNR/L 2020 K16	●	●	20	20	125	25	TNM. 1604..		AKV-01-M5x22	AATN-2-0002	AAV-03-M5x12	-	ABPL-01	AAL-03-3	
2525 M16	●	●	25	25	150	32									
3232 P16	●	●	32	32	170	40									
2525 M22	●	●	25	25	150	32	TNM. 2204..	ATK-02	AKV-30-M6x22	AATN-3-0015	AAV-02-M5x12	AS-01	ABPL-01	AAL-03-3	
3232 P22	●	●	32	32	170	40									
4040 S22	○	○	40	40	250	50									

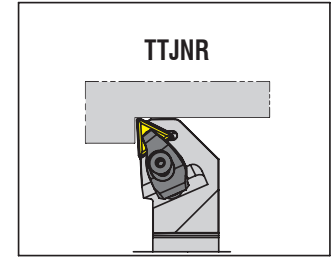
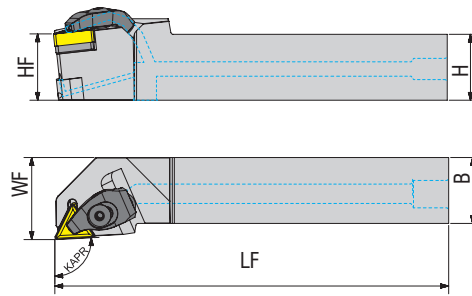

Takım Kodu Ordering Code Bestell-Bezeichnung	Stok Stock Lager		Takım Ölçüleri (mm) Dimension (mm) Abmessung (mm)				Kesici Uç Insert Wendeschneidplatte	Yedek Parçaları / Spare Parts / Ersatzteile							
	R	L	HF=H	B	LF	WF		Baskı Pabucu Wedge Clamp Spannpratze	Pabuç Vidası Clamp Screw Klemmschraube	Altlık Shim Unterlage	Altlık Vidası Shim Screw Schraube für Unterlage	Yay Spring Feder	Oring Ring Feder	Sızdırmaz Vidası Threaded Pin Резьбовой Вит	Anahtar Allen Key Innensechskantschlüssel
TTJNR/L 2525 M16-H	○	○	25	25	150	32	TNM. 1604..	ATKH-03-R ATKH-04-L	AKV-37-M5x18	AATN-2-000	AAV-03-M5x12	AKY-02	AXR-02	2705-G1/8x5.5	AAL-02-2.5
3232 P16-H	○	○	32	32	170	32									
2525 M22-H	○	○	25	25	150	40	TNM. 2204..	ATKH-01-R ATKH-02-L	AKV-33-M6x22	AATN-3-0015	AAV-02-M5x12	AKY-01	AXR-01	2705-G1/8x5.5	AAL-03-3
3232 P22-H	○	○	32	32	170	40									

R: Sağ / Right / Rechts L: Sol / Left / Links

● Stokta / In Stock / Auf Lager ○ Stokta Yok / Non Stock Item / Kein Lagerartikel, Lieferzeit auf Anfrage

Sipariş Örneği/Ordering Example/Bestellbeispiel

1 ad./pcs./stück TTJNR 2020 K16

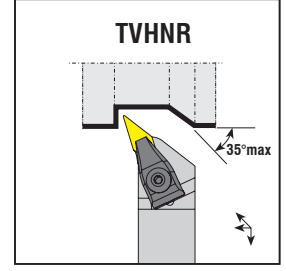
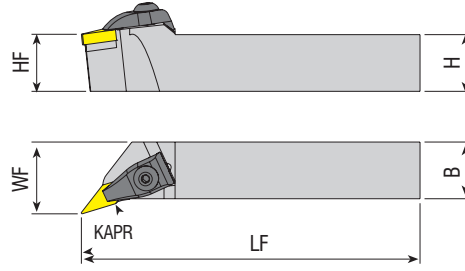

Takım Kodu Ordering Code Bestell-Bezeichnung	Stok Stock Lager		Takım Ölçüleri (mm) Dimension (mm) Abmessung (mm)				Kesici Uç Insert Wendeschneidplatte	Yedek Parçaları / Spare Parts / Ersatzteile								
	R	L	HF=H	B	LF	WF		Baskı Pabuçu Wedge Clamp Spannpratze	Pabuç Vidası Clamp Screw Klemmschraube	Altlık Shim Unterlage	Altlık Vidası Shim Screw Schraube für Unterlage	Segman Ring Feder	Pul Stamp Ring	Anahtar Allen Key Innensechskantschlüssel		
TVHNR/L 2020 K16	●	●	20	20	125	25	VNM. 1604..									
2525 M16	●	●	25	25	150	32										
3232 P16	●	●	32	32	170	40										

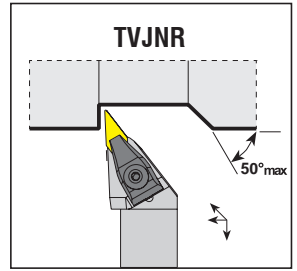
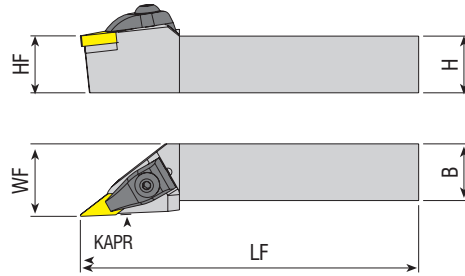

Takım Kodu Ordering Code Bestell-Bezeichnung	Stok Stock Lager		Takım Ölçüleri (mm) Dimension (mm) Abmessung (mm)				Kesici Uç Insert Wendeschneidplatte	Yedek Parçaları / Spare Parts / Ersatzteile								
	R	L	HF=H	B	LF	WF		Baskı Pabuçu Wedge Clamp Spannpratze	Pabuç Vidası Clamp Screw Klemmschraube	Altlık Shim Unterlage	Altlık Vidası Shim Screw Schraube für Unterlage	Segman Ring Feder	Pul Stamp Ring	Anahtar Allen Key Innensechskantschlüssel		
TVJNR/L 2020 K16	●	●	20	20	125	25	VNM. 1604..									
2525 M16	●	●	25	25	150	32										
3232 P16	●	●	32	32	170	40										

R: Sağ / Right / Rechts L: Sol / Left / Links  
● Stokta / In Stock / Auf Lager ○ Stokta Yok / Non Stock Item / Kein Lagerartikel, Lieferzeit auf Anfrage

Sipariş Örneği/Ordering Example/Bestellbeispiel  
1 ad./pcs./stück TVHNR 2020 K16



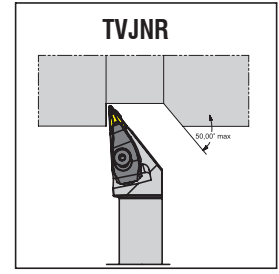
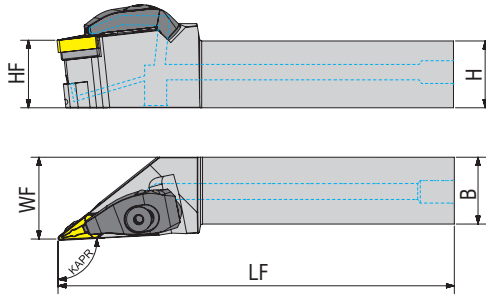

Takım Kodu Ordering Code Bestell-Bezeichnung	Stok Stock Lager		Takım Ölçüleri (mm) Dimension (mm) Abmessung (mm)				Kesici Uç Insert Wendeschneidplatte	Yedek Parçaları / Spare Parts / Ersatzteile															
	R	L	HF=H	B	LF	WF		Baskı Pabuçu Wedge Clamp Spannpratze	Pabuç Vidası Clamp Screw Klemmschraube	Altlık Shim Unterlage	Altlık Vidası Shim Screw Schraube für Unterlage	Yay Spring Feder	Oring Ring Feder	Sızdırmaz Vida Threaded Pin Резьбовой Винт	Anahtar Allen Key Innensechskantschlüssel								
TVJNR/L 2020 K16-H	○	○	20	20	125	25	VNM. 1604..																
2525 M16-H	○	○	25	25	150	32										ATKH-05-R	AKV-33-M6x22	AAVN-2-0002	AAV-04-M5x12	AKY-01	AXR-01	2705-G1/8x5.5	AAL-03-3
3232 P16-H	○	○	32	32	170	40										ATKH-06-L							

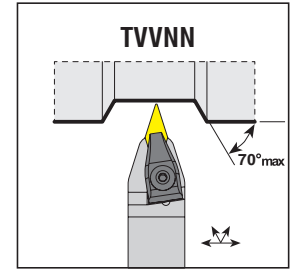
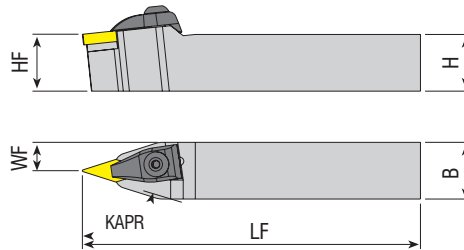

Takım Kodu Ordering Code Bestell-Bezeichnung	Stok Stock Lager	Takım Ölçüleri (mm) Dimension (mm) Abmessung (mm)				Kesici Uç Insert Wendeschneidplatte	Yedek Parçaları / Spare Parts / Ersatzteile														
		HF=H	B	LF	WF		Baskı Pabuçu Wedge Clamp Spannpratze	Pabuç Vidası Clamp Screw Klemmschraube	Altlık Shim Unterlage	Altlık Vidası Shim Screw Schraube für Unterlage	Segman Ring Feder	Pul Stamp Ring	Anahtar Allen Key Innensechskantschlüssel								
TVVNN 2020 K16	●	20	20	125	10	VNM. 1604..															
2525 M16	●	25	25	150	12.5										ATK-03	AKV-30-M6x22	AAVN-2-0002	AAV-04-M5x12	AS-01	ABPL-01	AAL-03-3
3232 P16	●	32	32	170	16																

R: Sağ / Right / Rechts L: Sol / Left / Links  
● Stokta / In Stock / Auf Lager ○ Stokta Yok / Non Stock Item / Kein Lagerartikel, Lieferzeit auf Anfrage

Sipariş Örneği/Ordering Example/Bestellbeispiel  
1 ad./pcs./stück TVJNR 2020 H16-H

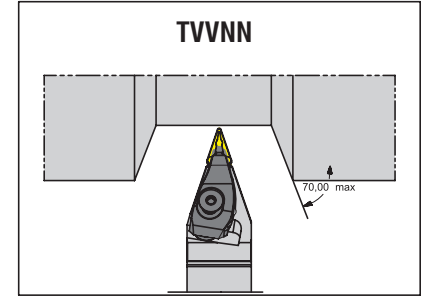
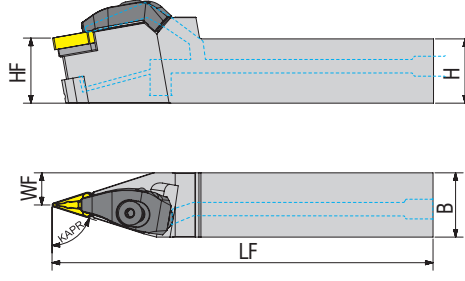

Takım Kodu Ordering Code Bestell-Bezeichnung	Stok Stock Lager		Takım Ölçüleri (mm) Dimension (mm) Abmessung (mm)				Kesici Uç Insert Wendeschneidplatte	Yedek Parçaları / Spare Parts / Ersatzteile									
	R	L	HF=H	B	LF	WF		Baskı Pabuçu Wedge Clamp Spannpratze	Pabuç Vidası Clamp Screw Klemmschraube	Altlık Shim Unterlage	Altlık Vidası Shim Screw Schraube für Unterlage	Yay Spring Feder	Oring Ring Feder	Sızdırmaz Vida Threaded Pin Резьбовой Винт	Anahtar Allen Key Innensechskantschlüssel		
<b>TVVNN 2020 K16-H</b>	○	○	20	20	125	10	<b>VNM. 1604..</b>	ATKH-05-R ATKH-06-L	AKV-33-M6x22	AAVN-2-0002	AAV-04-M5x12	AKY-01	AXR-01	2705-G1/8x5.5	AAL-03-3		
<b>2525 M16-H</b>	○	○	25	25	150	12.7											

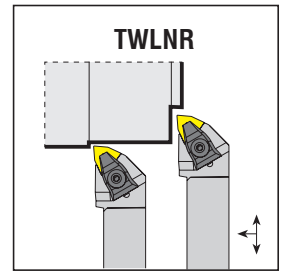
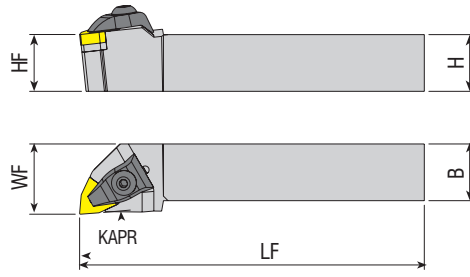

Takım Kodu Ordering Code Bestell-Bezeichnung	Stok Stock Lager		Takım Ölçüleri (mm) Dimension (mm) Abmessung (mm)				Kesici Uç Insert Wendeschneidplatte	Yedek Parçaları / Spare Parts / Ersatzteile									
	R	L	HF=H	B	LF	WF		Baskı Pabuçu Wedge Clamp Spannpratze	Pabuç Vidası Clamp Screw Klemmschraube	Altlık Shim Unterlage	Altlık Vidası Shim Screw Schraube für Unterlage	Segman Ring Feder	Pul Stamp Ring	Anahtar Allen Key Innensechskantschlüssel			
<b>TWLNR/L 1616 H06</b>	●	●	16	16	100	20	<b>WNM. 0604..</b>	ATK-01	AKV-01-M5x22	AAWN-SW317	AAV-01-M3x10	-	-	-	-		
<b>2020 K06</b>	●	●	20	20	125	25											
<b>2525 M06</b>	●	●	25	25	150	32											
<b>2020 K08</b>	●	●	20	20	125	25	<b>WNM. 0804..</b>	ATK-02	AKV-30-M6x22	AAWN-3-0001	AAV-02-M5x12	AS-01	ABPL-01	AAL-03-3			
<b>2525 M08</b>	●	●	25	25	150	32											
<b>3232 P08</b>	●	●	32	32	170	40											
<b>4040 S08</b>	●	●	40	40	250	50											
<b>5050 S08</b>	○	○	50	50	250	63											

R: Sağ / Right / Rechts L: Sol / Left / Links  
● Stokta / In Stock / Auf Lager ○ Stokta Yok / Non Stock Item / Kein Lagerartikel, Lieferzeit auf Anfrage

Sipariş Örneği/Ordering Example/Bestellbeispiel  
1 ad./pcs./stück TVVNN 2020 H16-H

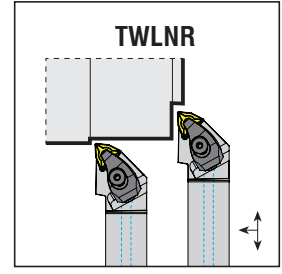
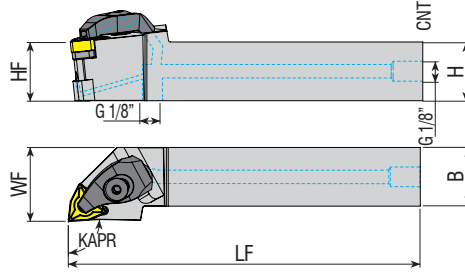

**Takım Kodu**  
**Ordering Code**  
**Bestell-Bezeichnung**

Stok Stock Lager	Takım Ölçüleri (mm) Dimension (mm) Abmessung (mm)						Kesici Uç Insert Wendeschneidplatte	Yedek Parçaları / Spare Parts / Ersatzteile									
	R	L	HF=H	B	LF	WF		Baskı Pabuçu Wedge Clamp Spannpratze	Pabuç Vidası Clamp Screw Klemmschraube	Altlık Shim Unterlage	Altlık Vidası Shim Screw Schraube für Unterlage	Yay Spring Feder	Oring Ring Feder	Sızdırmaz Vida Threaded Pin Резьбовой Винт	Anahtar Allen Key Innensechskantschlüssel		
							<b>WNM. 0804..</b>	ATKH-01-R ATKH-02-L	AKV-33-M6x22	AAWN-3-0001	AAV-13-M5x8	AKY-01	AXR-01	2705-G1/8x5.5	AAL-03-3		

R: Sağ / Right / Rechts L: Sol / Left / Links

● Stokta / In Stock / Auf Lager ○ Stokta Yok / Non Stock Item / Kein Lagerartikel, Lieferzeit auf Anfrage

Sipariş Örneği/Ordering Example/Bestellbeispiel

1 ad./pcs./stück TWLNR 2020 K08-H



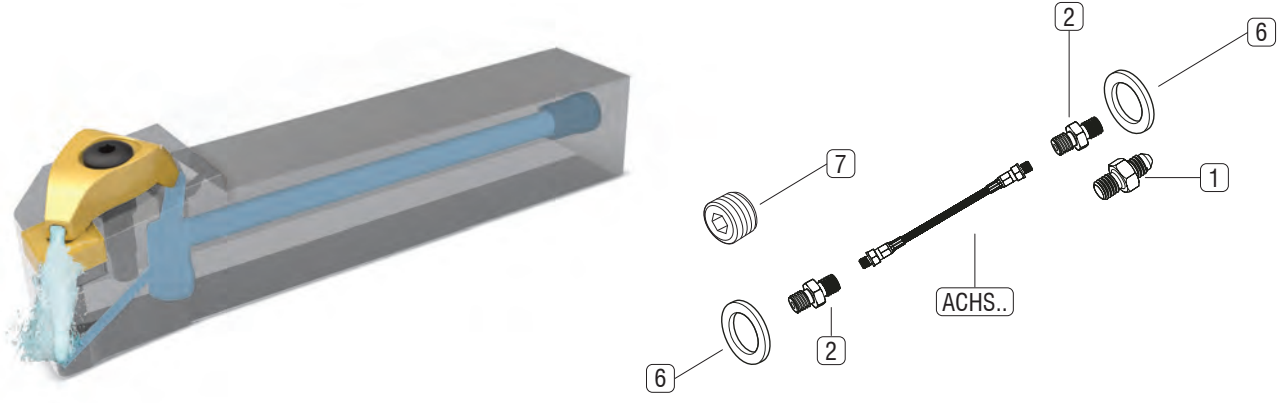

Not: İçten soğutmalı tüm torna katerlerinde kullanılabilecek 3 tip soğutma hortum setleri tasarlanmıştır. Takımların kullanılmasından önce, kullanılmayan bağlantıların set içindeki vida ile kapatılarak sızdırmazlığın sağlanmasına dikkat edilmelidir. Torna katerlerine yönelik soğutma hortum setleri, ACHS... 10 bar ile maksimum 275 bar basınç aralığında kullanılabilir.

Note: 3 types of cooling hose sets are designed that can be used in all internally cooled lathes. Before using the tools, care should be taken to ensure that the unused connections are closed with the screw in the set and that sealing is ensured. Cooling hose sets for lathe tools can be used in the pressure range of ACHS ... 10 bar to max 275 bar.

Notiz: Es wurden 3 Arten von Kühlschlauch-Sets entwickelt, die in allen intern gekühlten Drehmaschinen verwendet werden können. Vor der Verwendung der Werkzeuge sollte darauf geachtet werden, dass die nicht verwendeten Verbindungen mit der Schraube im Satz geschlossen werden und die Abdichtung gewährleistet ist. Kühlschlauchsätze für Drehmaschinen können im Druckbereich von ACHS ... 10 bar bis max. 275 bar eingesetzt werden.

Set İçindeki Parçalar Parts In The Set Teile Im Set				Uzunluk / Length Code / Länge		
				Set Kodu: Set Code: Code Einstellen: ACHS-1-250	Set Kodu: Set Code: Code Einstellen: ACHS-2-250	Set Kodu: Set Code: Code Einstellen: ACHS-3-250
1		AMP-01	M10 Bağlantı Elemanı M10 Fastener M10 Verschluss	1x	-	-
2		AMP-02	G 1/8" Çift Bağlantı Elemanı G 1/8" Double Fastener G 1/8" Doppelverschluss	2x	1x	-
3		AMP-03	G 1/8" Açılı Bağlantısı G 1/8" Angle Connection G 1/8" Winkelverbindung	-	1x	2x
4		AMP-04	M10" Açılı Bağlantısı M10" Angle Connection M10" Winkelverbindung	-	1x	1x
5		AMP-05	G1/4"-G1/8" Kılcalma Parçası G1 / 4"-G1/8" Capillary Piece G1 / 4"-G1/8" Kapillarstück	-	1x	1x
6		AG-01	Bakır Conta Copper Gasket Kupferdichtung	2x	3x	4x
7		2705-G1/8-5.5	G1/8" Sızdırmaz Civata G1/8" Sealing Bolt G1/8" Dichtungsschraube	1x	1x	1x
8		AH-1-250	Hortum Hose Schlauch	1x	-	-
9		AH-2-250	Hortum Hose Schlauch	-	1x	-
10		AH-3-250	Hortum Hose Schlauch	-	-	1x

# M-SİSTEM

**M-SİSTEM DIŞ TORNA KATERLERİ**  
M-SYSTEM EXTERNAL TURNING TOOLHOLDERS  
M-SYSTEM AUSSEN - DREHHALTER

*konusulan*  
**the spoken kalite...**  
*quality...*



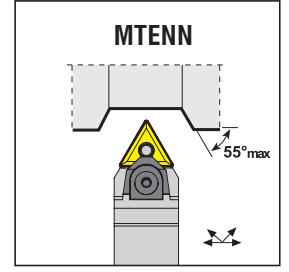
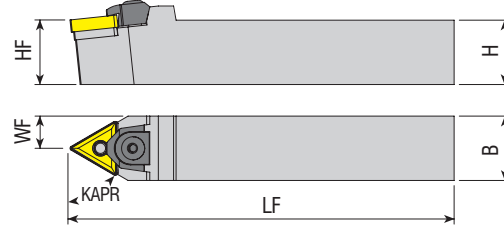

Takım Kodu Ordering Code Bestell-Bezeichnung	Stok Stock Lager	Takım Ölçüleri (mm) Dimension (mm) Abmessung (mm)				Kesici Uç Insert Wendeschneidplatte	Baskı Pabucu Wedge Clamp Spannpratze	Pabuç Vidası Clamp Screw Klemmschraube	Altlık Shim Unterlage	Pim Pin Штифт	Segman Ring Feder	Pul Stamp Ring	Anahtar Allen Key Innensechskantschlüssel
		HF=H	B	LF	WF								
MTENN 2020 K16	●	20	20	125	10	TNM. 1604..	AMK-04	AKV-30-M6x22	AATN-2-0002	APM-01	AS-01	ABPL-01	AAL-03-3
2525 M16	●	25	25	150	12.5								
3232 P16	●	32	32	170	16								
2525 M22	●	25	25	150	12.5	TNM. 2204..	AMK-08	AKV-30-M6x22	AATN-3-0015	APM-02	AS-01	ABPL-01	AAL-03-3
3232 P22	●	32	32	170	16								
4040 S22	●	40	40	250	20								

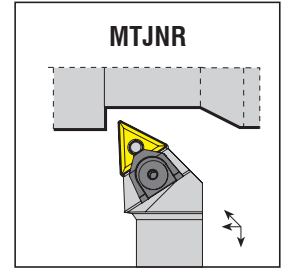
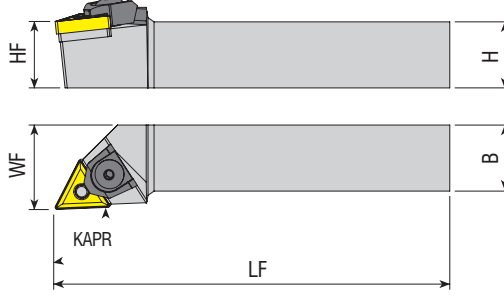
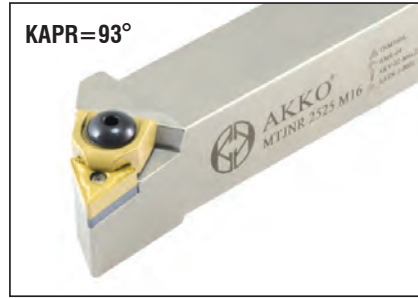

Takım Kodu Ordering Code Bestell-Bezeichnung	Stok Stock Lager		Takım Ölçüleri (mm) Dimension (mm) Abmessung (mm)				Kesici Uç Insert Wendeschneidplatte	Baskı Pabucu Wedge Clamp Spannpratze	Pabuç Vidası Clamp Screw Klemmschraube	Altlık Shim Unterlage	Pim Pin Штифт	Segman Ring Feder	Pul Stamp Ring	Anahtar Allen Key Innensechskantschlüssel
	R	L	HF=H	B	LF	WF								
MTJNR/L 2020 K16	●	●	20	20	125	25	TNM. 1604..	AMK-04	AKV-30-M6x22	AATN-2-0002	APM-01	AS-01	ABPL-01	AAL-03-3
2525 M16	●	●	25	25	150	32								
3232 P16	●	●	32	32	170	40								
2525 M22	●	●	25	25	150	32	TNM. 2204..	AMK-08	AKV-30-M6x22	AATN-3-0015	APM-02	AS-01	ABPL-01	AAL-03-3
3232 P22	●	●	32	32	170	40								
4040 S22	●	●	40	40	250	50								

R: Sağ / Right / Rechts L: Sol / Left / Links  
● Stokta / In Stock / Auf Lager ○ Stokta Yok / Non Stock Item / Kein Lagerartikel, Lieferzeit auf Anfrage

Sipariş Örneği/Ordering Example/Bestellbeispiel  
1 ad./pcs./stück MTENN 2020 K16

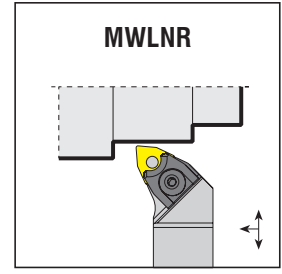
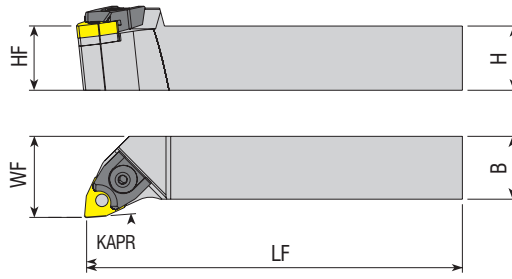

**Takım Kodu**  
**Ordering Code**  
**Bestell-Bezeichnung**

Yedek Parçaları / Spare Parts / Ersatzteile

Takım Kodu Ordering Code Bestell-Bezeichnung	Stok Stock Lager		Takım Ölçüleri (mm) Dimension (mm) Abmessung (mm)				Kesici Uç Insert Wendeschneidplatte	Baskı Pabucu Wedge Clamp Spannpratze	Pabuç Vidası Clamp Screw Klemmschraube	Altık Shim Unterlage	Pim Pin Штифт	Segman Ring Feder	Pul Stamp Ring	Anahtar Allen Key Innensechskantschlüssel
	R	L	HF=H	B	LF	WF								
<b>MWLNR/L 1616 H06</b>	●	●	16	16	100	20	<b>WNM. 0604..</b>	AMK-01	AKV-04-M5x17	-	APM-08	-	-	AAL-03-3
<b>2020 K06</b>	●	●	20	20	125	25								
<b>2525 M06</b>	●	●	25	25	150	32								
<b>2020 K08</b>	●	●	20	20	125	25	<b>WNM. 0804..</b>	AMK-05	AKV-03-M6x22	AAWN-3-0001	APM-02	AS-01	ABPL-01	
<b>2525 M08</b>	●	●	25	25	150	32								
<b>3232 P08</b>	●	●	32	32	170	40								

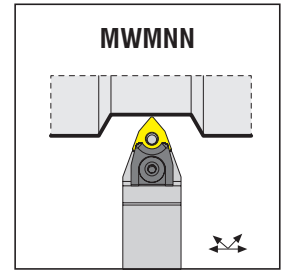
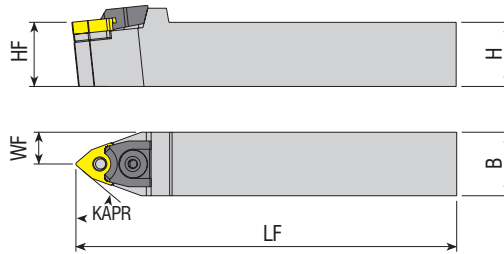

**Takım Kodu**  
**Ordering Code**  
**Bestell-Bezeichnung**

Yedek Parçaları / Spare Parts / Ersatzteile

Takım Kodu Ordering Code Bestell-Bezeichnung	Stok Stock Lager		Takım Ölçüleri (mm) Dimension (mm) Abmessung (mm)				Kesici Uç Insert Wendeschneidplatte	Baskı Pabucu Wedge Clamp Spannpratze	Pabuç Vidası Clamp Screw Klemmschraube	Altık Shim Unterlage	Pim Pin Штифт	Segman Ring Feder	Pul Stamp Ring	Anahtar Allen Key Innensechskantschlüssel
	R	L	HF=H	B	LF	WF								
<b>MWMNN 1616 H06</b>	●	●	16	16	100	8	<b>WNM. 0604..</b>	AMK-01	AKV-04-M5x17	-	APM-08	-	-	AAL-03-3
<b>2020 K06</b>	●	●	20	20	125	10								
<b>2525 M06</b>	●	●	25	25	150	12.5								
<b>2020 K08</b>	●	●	20	20	125	10	<b>WNM. 0804..</b>	AMK-05	AKV-03-M6x22	AAWN-3-0001	APM-02	AS-01	ABPL-01	
<b>2525 M08</b>	●	●	25	25	150	12.5								
<b>3232 P08</b>	●	●	32	32	170	16								

R: Sağ / Right / Rechts L: Sol / Left / Links

● Stokta / In Stock / Auf Lager ○ Stokta Yok / Non Stock Item / Kein Lagerartikel, Lieferzeit auf Anfrage

Sipariş Örneği/Ordering Example/Bestellbeispiel

1 ad./pcs./stück MWLNR 1616 H06



*konusulan  
the spoken kalite...  
quality...*

# P-SİSTEM

**P-SİSTEM DIŞ TORNA KATERLERİ**  
P-SYSTEM EXTERNAL TURNING TOOLHOLDERS  
P-SYSTEM AUSSEN - DREHHALTER



**DETAYLI BİLGİ İÇİN BARKODU OKUTUNUZ**  
SCAN ME FOR MORE DETAILS  
FÜR DETAILS BITTE DEN QR CODE SCANNEN



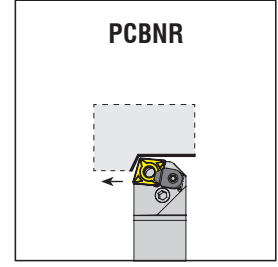
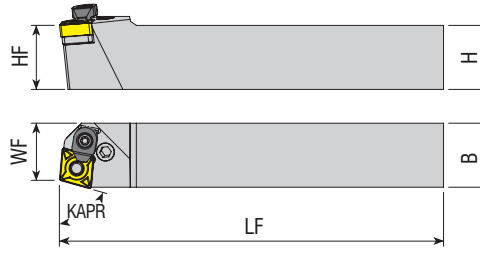

Takım Kodu Ordering Code Bestell-Bezeichnung	Stok Stock Lager		Takım Ölçüleri (mm) Dimension (mm) Abmessung (mm)				Kesici Uç Insert Wendeschneidplatte	Yedek Parçaları / Spare Parts / Ersatzteile								
	R	L	HF=H	B	LF	WF		Levyeye Lever Kniehebel	Levyeye Vidası Lever Screw Kniehebelschraube	Altık Shim Unterlage	Altık Yayı Shim Spring Feder für Unterlage	Baskı Parçası Wedge Clamp Spannpratze	Baskı Vidası Clamp Screw Klemmschraube	Anahtar Allen Key Innensechskantschlüssel		
<b>PCBNR/L 2020 K12C</b>	●	●	20	20	125	17.5	<b>CNM. 1204..</b>	APL-02	ALV-03-M8x19	AACN-3-0001	AAY-02	ACK-05	4015-M4x11	AAL-03-3		
<b>2525 M12C</b>	●	●	25	25	150	22.5										
<b>3232 P12C</b>	●	●	32	32	170	29.5										
<b>2525 M16C</b>	●	●	25	25	150	22	<b>CNM. 1606..</b>	APL-04	ALV-04-M8x22	AACN-3-0002	AAY-03					
<b>3232 P16C</b>	●	●	32	32	170	27										
<b>3232 P19C</b>	●	●	32	32	170	27										
<b>4040 S19C</b>	●	●	40	40	250	37	<b>CNM. 1906..</b>	APL-05	ALV-05-M10x27	AACN-3-0003	AAY-04	ACK-09	AAV-05-M6x15	AAL-05-4		
<b>4040 S25C</b>	●	●	40	40	250	37										
<b>5050 S25C</b>	○	○	50	50	250	47	<b>CNM. 2509..</b>	APL-06	ALV-06-M12x36	AACN-3-0008	AAY-05	ACK-04	AKV-16-M6x16	AAL-07-5		

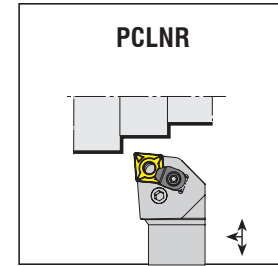
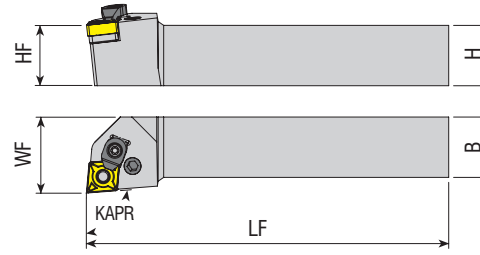

Takım Kodu Ordering Code Bestell-Bezeichnung	Stok Stock Lager		Takım Ölçüleri (mm) Dimension (mm) Abmessung (mm)				Kesici Uç Insert Wendeschneidplatte	Yedek Parçaları / Spare Parts / Ersatzteile								
	R	L	HF=H	B	LF	WF		Levyeye Lever Kniehebel	Levyeye Vidası Lever Screw Kniehebelschraube	Altık Shim Unterlage	Altık Yayı Shim Spring Feder für Unterlage	Baskı Parçası Wedge Clamp Spannpratze	Baskı Vidası Clamp Screw Klemmschraube	Anahtar Allen Key Innensechskantschlüssel		
<b>PCLNR/L 1616 H09</b>	●	●	16	16	100	20	<b>CNM. 0903..</b>	APL-01	ALV-02-M6x17	AACN-2-0002	AAY-01	-	-	AAL-02-2.5		
<b>2020 K09</b>	●	●	20	20	125	25										
<b>2525 M09</b>	●	●	25	25	150	32										
<b>1616 H12</b>	●	●	16	16	100	20	<b>CNM. 1204..</b>	APL-02	ALV-03-M8x19	AACN-3-0001	AAY-02	ACK-05	4015-M4x11	AAL-03-3		
<b>2020 K12C</b>	●	●	20	20	125	25										
<b>2525 M12C</b>	●	●	25	25	150	32										
<b>3232 P12C</b>	●	●	32	32	170	40	<b>CNM. 1606..</b>	APL-04	ALV-04-M8x22	AACN-3-0002	AAY-03					
<b>2525 M16C</b>	●	●	25	25	150	32										
<b>3232 P16C</b>	●	●	32	32	170	40										
<b>2525 M19C</b>	●	●	25	25	150	32	<b>CNM. 1906..</b>	APL-05	ALV-05-M10x27	AACN-3-0003	AAY-04	ACK-09	AAV-05-M6x15	AAL-05-4		
<b>3232 P19C</b>	●	●	32	32	170	40										
<b>4040 S19C</b>	●	●	40	40	250	50										
<b>4040 S25C</b>	●	●	40	40	250	50	<b>CNM. 2509..</b>	APL-06	ALV-06-M12x36	AACN-3-0008	AAY-05	ACK-04	AKV-16-M6x16	AAL-07-5		
<b>5050 S25C</b>	●	●	50	50	250	60										

R: Sağ / Right / Rechts L: Sol / Left / Links

● Stokta / In Stock / Auf Lager ○ Stokta Yok / Non Stock Item / Kein Lagerartikel, Lieferzeit auf Anfrage

Sipariş Örneği/Ordering Example/Bestellbeispiel  
1 ad./pcs./stück PCBNR 2020 K12C

KAPR=95°

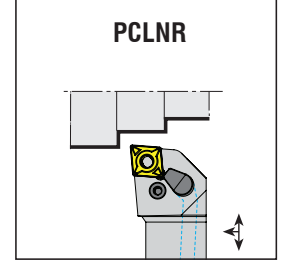
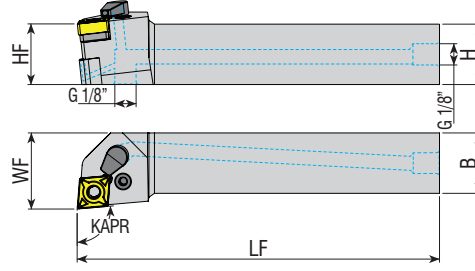

Takım Kodu Ordering Code Bestell-Bezeichnung	Stok Stock Lager		Takım Ölçüleri (mm) Dimension (mm) Abmessung (mm)				Kesici Uç Insert Wendeschneidplatte	Levyeye Lever Kniehebel	Levyeye Vidası Lever Screw Kniehebelschraube	Altılık Shim Unterlage	Altılık Yayını Shim Spring Feder für Unterlage	Oring Ring Feder	Sızdırmaz Vida Threaded Pin Резьбовой Винт	Nozul Spannpratze Spannpratze	Anahtar Allen Key Innensechskantschlüssel								
	R	L	HF=H	B	LF	WF																	
PCLNR/L 2020 K12-H	●	●	20	20	125	25	CNM. 1204..	APL-02	ALV-03-M8x19	AACN-3-0001	AAY-02	AXR-01 AOR-01	2705-G1/8x5.5	AN-01	AAL-03-3								
2525 M12-H	●	●	25	25	150	32																	
3232 P12-H	●	○	32	32	170	40																	
<b>new</b> 3232 P16-H	●	○	32	32	170	40										CNM. 1606..	APL-04	ALV-04-M8x22	AACN-3-0002	AAY-03			AAL-03-4
<b>new</b> 3232 P19-H	●	○	32	32	170	40										CNM. 1906..	APL-05	ALV-05-M10x27	AACN-3-0003	AAY-04			AAL-03-4

KAPR=50°

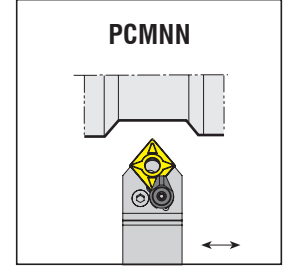
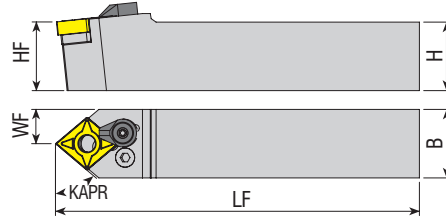

Takım Kodu Ordering Code Bestell-Bezeichnung	Stok Stock Lager		Takım Ölçüleri (mm) Dimension (mm) Abmessung (mm)				Kesici Uç Insert Wendeschneidplatte	Levyeye Lever Kniehebel	Levyeye Vidası Lever Screw Kniehebelschraube	Altılık Shim Unterlage	Altılık Yayını Shim Spring Feder für Unterlage	Baskı Parçası Wedge Clamp Spannpratze	Baskı Vidası Clamp Screw Klemmschraube	Anahtar Allen Key Innensechskantschlüssel
	R	L	HF=H	B	LF	WF								
PCMNN 2020 K12C	●	●	20	20	125	10	CNM. 1204..	APL-02	ALV-03-M8x19	AACN-3-0001	AAY-02	ACK-05	4015-M4x11	AAL-03-3
2525 M12C	●	●	25	25	150	12.5								
3232 P12C	○	○	32	32	170	16								
2525 M16C	○	○	25	25	150	12.5	CNM. 1606..	APL-04	ALV-04-M8x22	AACN-3-0002	AAY-03			
3232 P16C	○	○	32	32	170	16								
3232 P19C	●	○	32	32	170	16	CNM. 1906..	APL-05	ALV-05-M10x27	AACN-3-0003	AAY-04	ACK-09	AAV-05-M6x15	AAL-05-4
4040 S19C	●	○	40	40	250	20								
5050 S19C	○	○	50	50	250	25								
4040 S25C	●	○	40	40	250	20	CNM. 2509..	APL-06	ALV-06-M12x36	AACN-3-0008	AAY-05	ACK-04	AKV-16-M6x16	AAL-07-5

R: Sağ / Right / Rechts L: Sol / Left / Links

● Stokta / In Stock / Auf Lager ○ Stokta Yok / Non Stock Item / Kein Lagerartikel, Lieferzeit auf Anfrage

Sipariş Örneği/Ordering Example/Bestellbeispiel

1 ad./pcs./stück PCLNR 2020 K12-H

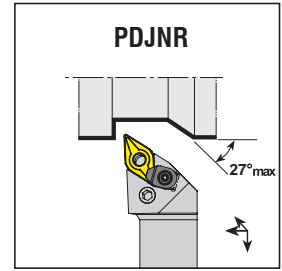
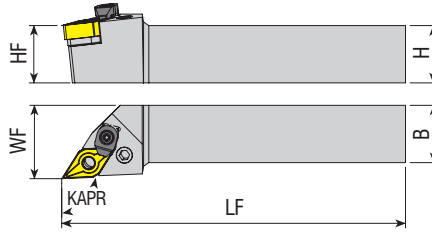

Takım Kodu Ordering Code Bestell-Bezeichnung	Stok Stock Lager		Takım Ölçüleri (mm) Dimension (mm) Abmessung (mm)				Kesici Uç Insert Wendeschneidplatte	Leyve Lever Kniehebel	Leyve Vidası Lever Screw Kniehebelschraube	Altlık Shim Unterlage	Altlık Yayı Shim Spring Feder für Unterlage	Baskı Parçası Wedge Clamp Spannpratze	Baskı Vidası Clamp Screw Klemmschraube	Anahtar Allen Key Inmenschkartenschlüssel
	R	L	HF=H	B	LF	WF								
<b>PDJNR/L 1616 H11</b>	●	●	16	16	100	20	<b>DNM. 1104..</b>	APL-01	ALV-02-M6x17	AADN-SD317	AAY-01	-	-	AAL-02-2.5
<b>2020 K11</b>	●	●	20	20	125	25								
<b>2525 M11</b>	●	●	25	25	150	32								
<b>2020 K15C</b>	●	●	20	20	125	25								
<b>2525 M15C</b>	●	●	25	25	150	32								
<b>3232 P15C</b>	●	●	32	32	170	40								
<b>4040 S15C</b>	●	●	40	40	250	50	<b>DNM. 1506..</b>	APL-03	ALV-03-M8x19	AADN-3-0001	AAY-02	ACK-05	4015-M4x11	AAL-03-3

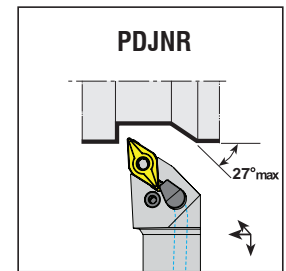
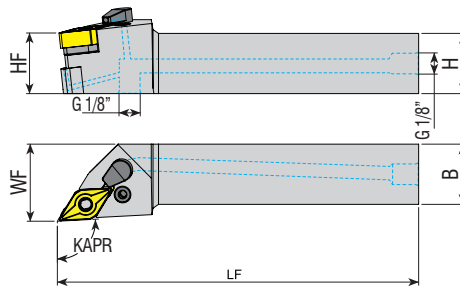

Takım Kodu Ordering Code Bestell-Bezeichnung	Stok Stock Lager		Takım Ölçüleri (mm) Dimension (mm) Abmessung (mm)				Kesici Uç Insert Wendeschneidplatte	Leyve Lever Kniehebel	Leyve Vidası Lever Screw Kniehebelschraube	Altlık Shim Unterlage	Altlık Yayı Shim Spring Feder für Unterlage	Oring Ring Feder	Sızdırmaz Vida Threaded Plug Резьбовой Винт	Nozul Spannpratze Spannpratze	Anahtar Allen Key Inmenschkartenschlüssel
	R	L	HF=H	B	LF	WF									
<b>PDJNR/L 2020 K15-H</b>	●	●	20	20	125	25	<b>DNM. 1506..</b>	APL-03	ALV-03-M8x19	AADN-3-0001	AAY-02	AXR-01 AOR-01	2705-G1/8x5.5	AN-01	AAL-03-3
<b>2525 M15-H</b>	●	●	25	25	150	32									
<b>3232 P15-H</b>	●	○	32	32	170	40									

R: Sağ / Right / Rechts L: Sol / Left / Links  
● Stokta / In Stock / Auf Lager ○ Stokta Yok / Non Stock Item / Kein Lagerartikel, Lieferzeit auf Anfrage

Sipariş Örneği/Ordering Example/Bestellbeispiel  
1 ad./pcs./stück PDJNR 1616 H11

KAPR=62.5°

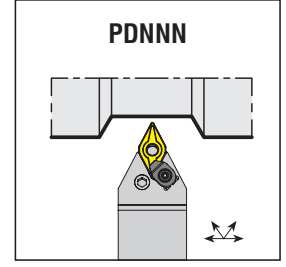
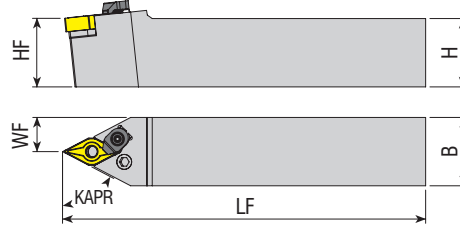

**Takım Kodu**  
**Ordering Code**  
**Bestell-Bezeichnung**

Stok Stock Lager	Takım Ölçüleri (mm) Dimension (mm) Abmessung (mm)				Kesici Uç Insert Wendeschneidplatte	Yedek Parçaları / Spare Parts / Ersatzteile							
	HF=H	B	LF	WF		Levyeye Lever Kniehebel	Levyeye Vidası Lever Screw Kniehebelschraube	Altılık Shim Unterlage	Altılık Yayı Shim Spring Feder für Unterlage	Baskı Parçası Wedge Clamp Spannpratze	Baskı Vidası Clamp Screw Klemmschraube	Anahtar Allen Key Innensechskantschlüssel	
<b>PDNHN 1616 H11</b>	●	16	16	100	8								
<b>2020 K11</b>	●	20	20	125	10	<b>DNM. 1104..</b>	APL-01	ALV-02-M6x17	AADN-SD317	AAY-01	-	-	AAL-02-2.5
<b>2525 M11</b>	●	25	25	150	12.5								
<b>2020 K15C</b>	●	20	20	125	10								
<b>2525 M15C</b>	●	25	25	150	12.5	<b>DNM. 1506..</b>	APL-03	ALV-03-M8x19	AADN-3-0001	AAY-02	ACK-05	4015-M4x11	AAL-03-3
<b>3232 P15C</b>	●	32	32	170	16								

KAPR=62.5°

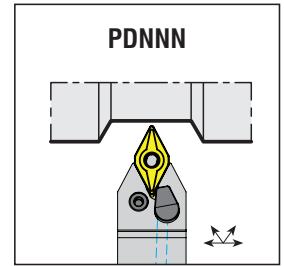
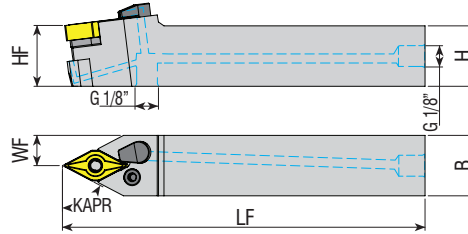
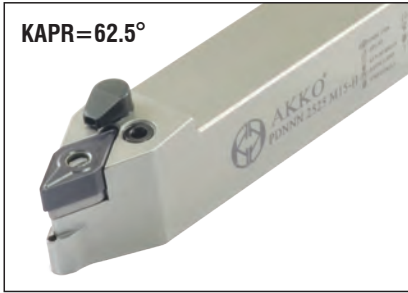

**Takım Kodu**  
**Ordering Code**  
**Bestell-Bezeichnung**

Stok Stock Lager	Takım Ölçüleri (mm) Dimension (mm) Abmessung (mm)				Kesici Uç Insert Wendeschneidplatte	Yedek Parçaları / Spare Parts / Ersatzteile								
	HF=H	B	LF	WF		Levyeye Lever Kniehebel	Levyeye Vidası Lever Screw Kniehebelschraube	Altılık Shim Unterlage	Altılık Yayı Shim Spring Feder für Unterlage	Oring Ring Feder	Sızdırmaz Vida Threaded Pin Резьбовой Винт	Nozul Spannpratze Spannpratze DOW	Anahtar Allen Key Innensechskantschlüssel	
<b>PDNHN 2525 M15-H</b>	●	25	25	150	32	<b>DNM. 1506..</b>	APL-03	ALV-03-M8x19	AADN-3-0001	AAY-02	AXR-01 AOR-01	2705-G1/8x5.5	AN-01	AAL-03-3

R: Sağ / Right / Rechts L: Sol / Left / Links

● Stokta / In Stock / Auf Lager ○ Stokta Yok / Non Stock Item / Kein Lagerartikel, Lieferzeit auf Anfrage

Sipariş Örneği/Ordering Example/Bestellbeispiel

1 ad./pcs./stück PDNHN 1616 H11



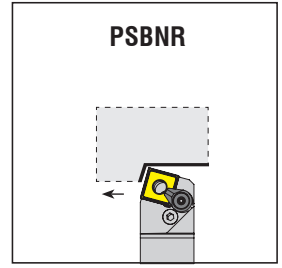
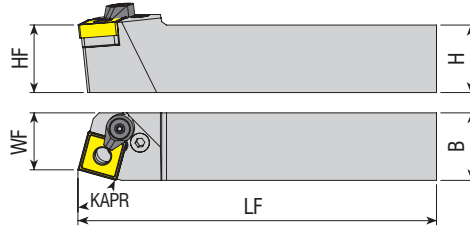

Takım Kodu Ordering Code Bestell-Bezeichnung	Stok Stock Lager		Takım Ölçüleri (mm) Dimension (mm) Abmessung (mm)				Kesici Uç Insert Wendeschneidplatte	Yedek Parçaları / Spare Parts / Ersatzteile						
	R	L	HF=H	B	LF	WF		Levyeye Lever	Levyeye Vidası Lever Screw	Altılık Shim	Altılık Yay Shim Spring	Baskı Parçası Wedge Clamp	Baskı Vidası Clamp Screw	Anahtar Allen Key
								Kniehebel	Kniehebelschraube	Unterlage	Feder für Unterlage	Spannpratze	Klemmschraube	Innenschlüssel
<b>PSBNR/L 1616 H09</b>	●	●	16	16	100	13	SNM. 0903..	APL-01	ALV-02-M6x17	AASN-2-0002	AAY-01	-	-	AAL-02-2.5
<b>2020 K09</b>	○	○	20	20	125	17								
<b>2020 K12</b>	●	●	20	20	125	17								
<b>2525 M12C</b>	●	●	25	25	150	22	SNM. 1204..	APL-02	ALV-03-M8x19	AASN-3-0004	AAY-02	ACK-05	4015-M4x11	AAL-03-3
<b>3232 P12C</b>	●	●	32	32	170	27								
<b>2525 M15</b>	●	●	25	25	150	22	SNM. 1506..	APL-04	ALV-04-M8x22	AASN-3-0023	AAY-03	-	-	-
<b>3232 P15C</b>	●	●	32	32	170	27								
<b>3232 P19C</b>	●	●	32	32	170	27	SNM. 1906..	APL-05	ALV-05-M10x27	AASN-3-0005	AAY-04	ACK-09	AAV-05-M6x15	AAL-05-4
<b>4040 S19C</b>	●	●	40	40	250	35								
<b>4040 S25C</b>	●	●	40	40	250	35	SNM. 2509..	APL-06	ALV-06-M12x36	AASN-3-0020	AAY-05	ACK-04	AKV-16-M6x16	AAL-07-5
<b>5050 S25C</b>	●	○	50	50	250	43								

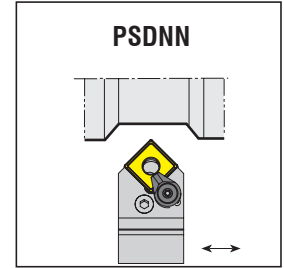
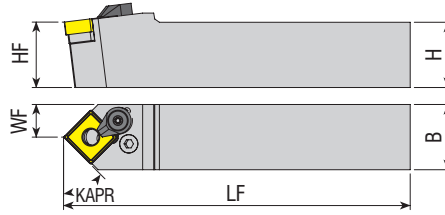
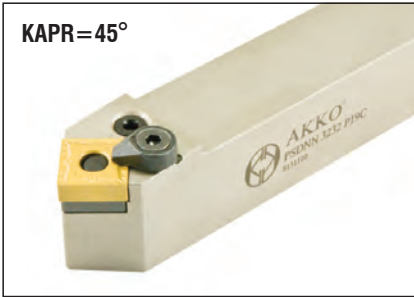

Takım Kodu Ordering Code Bestell-Bezeichnung	Stok Stock Lager		Takım Ölçüleri (mm) Dimension (mm) Abmessung (mm)				Kesici Uç Insert Wendeschneidplatte	Yedek Parçaları / Spare Parts / Ersatzteile						
			HF=H	B	LF	WF		Levyeye Lever	Levyeye Vidası Lever Screw	Altılık Shim	Altılık Yay Shim Spring	Baskı Parçası Wedge Clamp	Baskı Vidası Clamp Screw	Anahtar Allen Key
								Kniehebel	Kniehebelschraube	Unterlage	Feder für Unterlage	Spannpratze	Klemmschraube	Innenschlüssel
<b>PSDNN 1616 H09</b>	●	●	16	16	100	8	SNM. 0903..	APL-01	ALV-02-M6x17	AASN-2-0002	AAY-01	-	-	AAL-02-2.5
<b>2020 K12C</b>	●	●	20	20	125	10								
<b>2525 M12C</b>	●	●	25	25	150	12.5								
<b>3232 P12C</b>	●	●	32	32	170	16	SNM. 1204..	APL-02	ALV-03-M8x19	AASN-3-0004	AAY-02	ACK-05	4015-M4x11	AAL-03-3
<b>2020 K15</b>	●	●	20	20	125	10								
<b>2525 M15C</b>	●	●	25	25	150	12.5	SNM. 1506..	APL-04	ALV-04-M8x22	AASN-3-0023	AAY-03	-	-	-
<b>3232 P19C</b>	●	●	32	32	170	16								
<b>4040 S19C</b>	○	○	40	40	250	20	SNM. 1906..	APL-05	ALV-05-M10x27	AASN-3-0005	AAY-04	ACK-09	AAV-05-M6x15	AAL-05-4
<b>5050 S19C</b>	○	○	50	50	250	25								
<b>4040 S25C</b>	●	●	40	40	250	20	SNM. 2509..	APL-06	ALV-06-M12x36	AASN-3-0020	AAY-05	ACK-04	AKV-16-M6x16	AAL-07-5
<b>5050 S25C</b>	○	○	50	50	250	25								

R: Sağ / Right / Rechts L: Sol / Left / Links

● Stokta / In Stock / Auf Lager ○ Stokta Yok / Non Stock Item / Kein Lagerartikel, Lieferzeit auf Anfrage

Sipariş Örneği/Ordering Example/Bestellbeispiel

1 ad./pcs./stück PSBNR 1616 H09

KAPR=75°

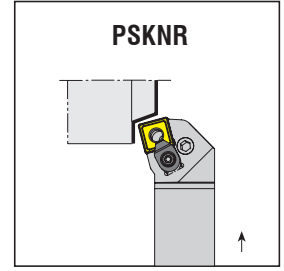
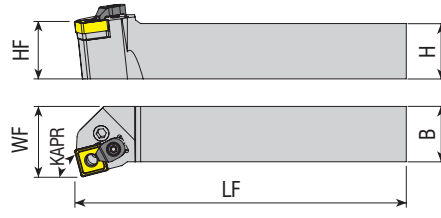

**Takım Kodu**  
**Ordering Code**  
**Bestell-Bezeichnung**

Stok  
Stock  
Lager

Takım Ölçüleri (mm)  
Dimension (mm)  
Abmessung (mm)

Kesici Uç  
Insert  
Wendeschneidplatte

Levyeye  
Lever  
Kniehebel

Levyeye Vidası  
Lever Screw  
Kniehebelschraube

Aitlik  
Shim  
Unterlage

Aitlik Yayı  
Shim Spring  
Feder für Unterlage

Baskı Parçası  
Wedge Clamp  
Spannpratze

Baskı Vidası  
Clamp Screw  
Klemmschraube

Anahtar  
Allen Key  
Innensechskantschlüssel

R L

HF=H

B

LF

WF

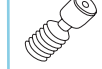

**PSKNR/L 2020 K09**  
**2020 K12C**  
**2525 M12C**  
**3232 P12C**  
**2525 M15C**  
**3232 P15C**  
**3232 P19C**  
**4040 S19C**  
**4040 S25C**  
**5050 S25C**

● ○ ● ● ● ● ● ● ● ● ● ○

20 20 25 32 25 32 32 40 40 50

20 20 25 32 25 32 32 40 40 50

125 125 150 170 150 170 170 250 250 250

25 25 32 40 32 40 40 50 50 60

**SNM. 0903..**  
**SNM. 1204..**  
**SNM. 1506..**  
**SNM. 1906..**  
**SNM. 2509..**

APL-01  
APL-02  
APL-04  
APL-05  
APL-06

ALV-02-M6x17  
ALV-03-M8x19  
ALV-04-M8x22  
ALV-05-M10x27  
ALV-06-M12x36

AASN-2-0002  
AASN-3-0004  
AASN-3-0023  
AASN-3-0005  
AASN-3-0020

AAAY-01  
AAAY-02  
AAAY-03  
AAAY-04  
AAAY-05

-  
ACK-05  
ACK-09  
ACK-04

-  
4015-M4x11  
AAV-05-M6x15  
AKV-16-M6x16

AAL-02-2.5  
AAL-03-3  
AAL-05-4  
AAL-07-5

KAPR=45°

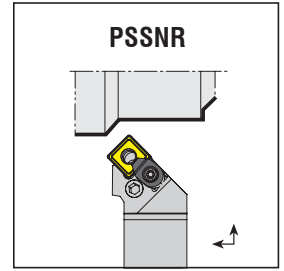
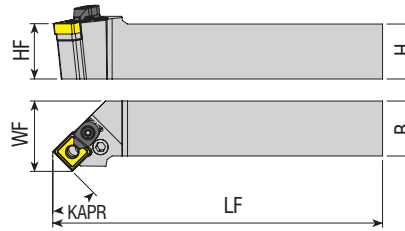

**Takım Kodu**  
**Ordering Code**  
**Bestell-Bezeichnung**

Stok  
Stock  
Lager

Takım Ölçüleri (mm)  
Dimension (mm)  
Abmessung (mm)

Kesici Uç  
Insert  
Wendeschneidplatte

Levyeye  
Lever  
Kniehebel

Levyeye Vidası  
Lever Screw  
Kniehebelschraube

Aitlik  
Shim  
Unterlage

Aitlik Yayı  
Shim Spring  
Feder für Unterlage

Baskı Parçası  
Wedge Clamp  
Spannpratze

Baskı Vidası  
Clamp Screw  
Klemmschraube

Anahtar  
Allen Key  
Innensechskantschlüssel

R L

HF=H

B

LF

WF



**PSSNR/L 1616 H09**  
**2020 K09**  
**2020 K12C**  
**2525 M12C**  
**3232 P12C**  
**3232 P15C**  
**3232 P19C**  
**4040 S19C**  
**4040 S25C**

● ● ● ● ● ● ● ● ● ●

16 20 20 25 32 32 32 40 40

16 20 20 25 32 32 32 40 40

100 125 125 150 170 170 170 250 250

20 25 25 32 40 40 40 50 50

**SNM. 0903..**  
**SNM. 1204..**  
**SNM. 1506..**  
**SNM. 1906..**  
**SNM. 2509..**

APL-01  
APL-02  
APL-04  
APL-05  
APL-06

ALV-02-M6x17  
ALV-03-M8x19  
ALV-04-M8x22  
ALV-05-M10x27  
ALV-06-M12x36

AASN-2-0002  
AASN-3-0004  
AASN-3-0023  
AASN-3-0005  
AASN-3-0020

AAAY-01  
AAAY-02  
AAAY-03  
AAAY-04  
AAAY-05

-  
ACK-05  
ACK-09  
ACK-04

-  
4015-M4x11  
AAV-05-M6x15  
AKV-16-M6x16

AAL-02-2.5  
AAL-03-3  
AAL-05-4  
AAL-07-5

R: Sağ / Right / Rechts L: Sol / Left / Links

● Stokta / In Stock / Auf Lager ○ Stokta Yok / Non Stock Item / Kein Lagerartikel, Lieferzeit auf Anfrage

Sipariş Örneği/Ordering Example/Bestellbeispiel

1 ad./pcs./stück PSKNR 2020 K09

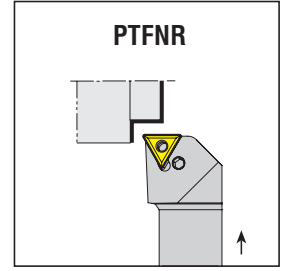
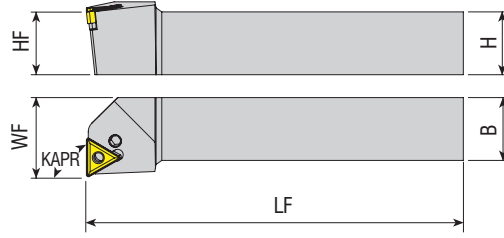

Takım Kodu Ordering Code Bestell-Bezeichnung	Stok Stock Lager		Takım Ölçüleri (mm) Dimension (mm) Abmessung (mm)				Kesici Uç Insert Wendeschneidplatte	Yedek Parçaları / Spare Parts / Ersatzteile						
	R	L	HF=H	B	LF	WF		Levyeye Lever Kniehebel	Levyeye Vidası Lever Screw Kniehebelschraube	Altılık Shim Unterlage	Altılık Yay Shim Spring Feder für Unterlage	Baskı Parçası Wedge Clamp Spannpratze	Baskı Vidası Clamp Screw Klemmschraube	Anahtar Allen Key Innensechskantschlüssel
<b>PTFNR/L 1616 H16</b>	●	●	16	16	100	20	<b>TNM. 1604..</b>	APL-01	ALV-02-M6x17	AATN-3-0025	AAY-01	-	-	AAL-02-2.5
<b>2020 K16</b>	●	●	20	20	125	25								
<b>2525 M16</b>	●	●	25	25	150	32								
<b>3232 P16</b>	●	●	32	32	170	40								
<b>2525 M22C</b>	●	●	25	25	150	32	<b>TNM. 2204..</b>	APL-02	ALV-03-M8x19	AATN-3-0015	AAY-02	ACK-05	4015-M4x11	AAL-03-3
<b>3232 P22C</b>	●	●	32	32	170	40								
<b>4040 S27C</b>	○	○	40	40	250	50	<b>TNM. 2706..</b>	APL-05	ALV-05-M10x27	AATN-3-0027	AAY-04	ACK-09	AAV-05-M6x15	AAL-05-4

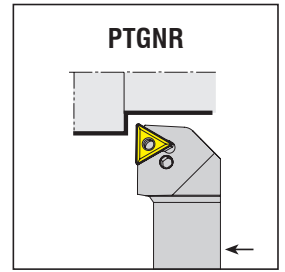
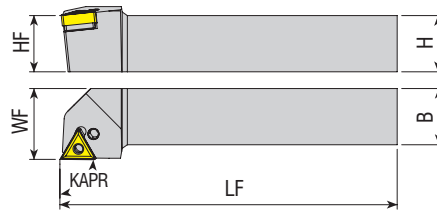

Takım Kodu Ordering Code Bestell-Bezeichnung	Stok Stock Lager		Takım Ölçüleri (mm) Dimension (mm) Abmessung (mm)				Kesici Uç Insert Wendeschneidplatte	Yedek Parçaları / Spare Parts / Ersatzteile						
	R	L	HF=H	B	LF	WF		Levyeye Lever Kniehebel	Levyeye Vidası Lever Screw Kniehebelschraube	Altılık Shim Unterlage	Altılık Yay Shim Spring Feder für Unterlage	Baskı Parçası Wedge Clamp Spannpratze	Baskı Vidası Clamp Screw Klemmschraube	Anahtar Allen Key Innensechskantschlüssel
<b>PTGNR/L 1010 E11</b>	○	○	10	10	70	12	<b>TNM. 1103..</b>	APL-11	ALV-10-M5x10	-	-	-	-	AAL-13-2.5
<b>1212 F11</b>	○	○	12	12	80	16								
<b>1616 H11</b>	○	○	16	16	100	20								
<b>1616 H16</b>	●	●	16	16	100	20	<b>TNM. 1604..</b>	APL-01	ALV-02-M6x17	AATN-3-0025	AAY-01	-	-	AAL-02-2.5
<b>2020 K16</b>	●	●	20	20	125	25								
<b>2525 M16</b>	●	●	25	25	150	32								
<b>3232 P16</b>	○	○	32	32	170	40								
<b>2525 M22C</b>	●	●	25	25	150	32	<b>TNM. 2204..</b>	APL-02	ALV-03-M8x19	AATN-3-0015	AAY-02	ACK-05	4015-M4x11	AAL-03-3
<b>3232 P22C</b>	●	●	32	32	170	40								
<b>4040 S27C</b>	○	○	40	40	250	50	<b>TNM. 2706..</b>	APL-05	ALV-05-M10x27	AATN-3-0027	AAY-04	ACK-09	AAV-05-M6x15	AAL-05-4

R: Sağ / Right / Rechts L: Sol / Left / Links  
● Stokta / In Stock / Auf Lager ○ Stokta Yok / Non Stock Item / Kein Lagerartikel, Lieferzeit auf Anfrage

Sipariş Örneği/Ordering Example/Bestellbeispiel  
1 ad./pcs./stück PTFNR 1616 H16

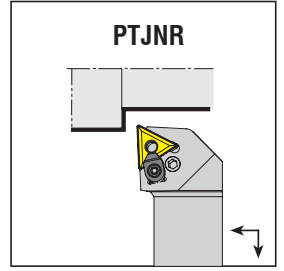
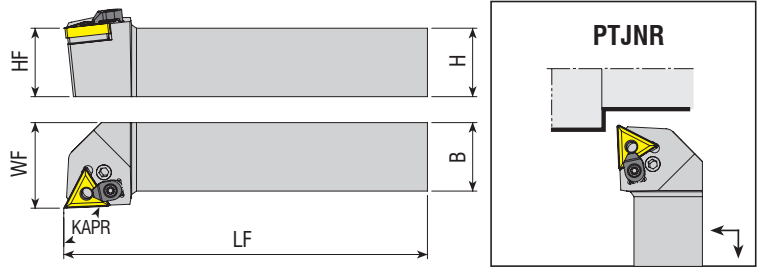

Takım Kodu Ordering Code Bestell-Bezeichnung	Stok Stock Lager		Takım Ölçüleri (mm) Dimension (mm) Abmessung (mm)				Kesici Uç Insert Wendeschneidplatte	Yedek Parçaları / Spare Parts / Ersatzteile							
	R	L	HF=H	B	LF	WF		Levye Lever Kniehebel	Levye Vidası Lever Screw Kniehebelschraube	Altılık Shim Unterlage	Altılık Yay Shim Spring Feder für Unterlage	Baskı Parçası Wedge Clamp Spannpratze	Baskı Vidası Clamp Screw Klemmschraube	Anahtar Allen Key Innensechskantschlüssel	
PTJNR/L 1010 E11	○	○	10	10	70	12	TNM. 1103..								
1212 F11	○	○	12	12	80	16									
1616 H11	○	○	16	16	100	20									
1616 H16	●	●	16	16	100	20	TNM. 1604..								
2020 K16	●	●	20	20	125	25									
2525 M16	●	●	25	25	150	32									
3232 P16	●	●	32	32	170	40									
2525 M22C	●	●	25	25	150	32	TNM. 2204..								
3232 P22C	●	●	32	32	170	40									
4040 S27C	●	○	40	40	250	50	TNM. 2706..								

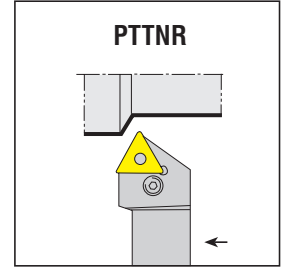
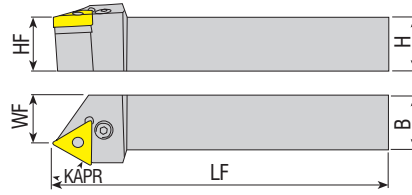
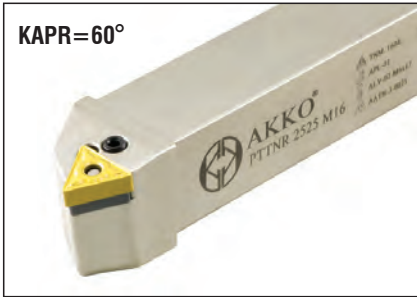

Takım Kodu Ordering Code Bestell-Bezeichnung	Stok Stock Lager		Takım Ölçüleri (mm) Dimension (mm) Abmessung (mm)				Kesici Uç Insert Wendeschneidplatte	Yedek Parçaları / Spare Parts / Ersatzteile							
	R	L	HF=H	B	LF	WF		Levye Lever Kniehebel	Levye Vidası Lever Screw Kniehebelschraube	Altılık Shim Unterlage	Altılık Yay Shim Spring Feder für Unterlage	Baskı Parçası Wedge Clamp Spannpratze	Baskı Vidası Clamp Screw Klemmschraube	Anahtar Allen Key Innensechskantschlüssel	
PTTNR/L 1616 H16	●	●	16	16	100	13	TNM. 1604..								
2020 K16	●	●	20	20	125	17									
2525 M16	●	●	25	25	150	21.5									
3232 P16	●	●	32	32	170	31	TNM. 2204..								
2525 M22C	●	●	25	25	150	20.5									
3232 P22C	●	●	32	32	170	29									

R: Sağ / Right / Rechts L: Sol / Left / Links  
● Stokta / In Stock / Auf Lager ○ Stokta Yok / Non Stock Item / Kein Lagerartikel, Lieferzeit auf Anfrage

Sipariş Örneği/Ordering Example/Bestellbeispiel  
1 ad./pcs./stück PTJNR 1010 E11



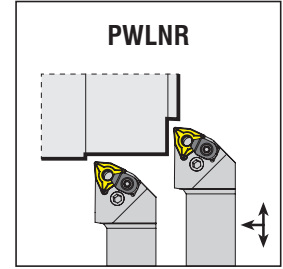
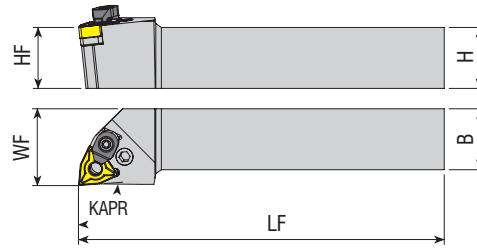

Takım Kodu Ordering Code Bestell-Bezeichnung	Stok Stock Lager		Takım Ölçüleri (mm) Dimension (mm) Abmessung (mm)				Kesici Uç Insert Wendeschneidplatte	Yedek Parçaları / Spare Parts / Ersatzteile						
	R	L	HF=H	B	LF	WF		Levye	Levye Vidası	Altlık	Altlık Yayı	Baskı Parçası	Baskı Vidası	Anahtar
								Lever	Lever Screw	Shim	Shim Spring	Wedge Clamp	Clamp Screw	İnnerschlüsselschlüssel
PWNLR/L 1616 H06	●	●	16	16	100	20	WNM. 0604..	APL-01	ALV-02-M6x17	AAWN-SW317	AAY-01	-	-	AAL-02-2.5
2020 K06	●	●	20	20	125	25								
2525 M06	●	●	25	25	150	32								
3232 P06	○	○	32	32	170	40								
1616 H08	●	●	16	16	100	20	WNM. 0804..	APL-02	ALV-03-M8x19	AAWN-3-0001	AAY-02	ACK-05	4015-M4x11	AAL-03-3
2020 K08C	●	●	20	20	125	25								
2525 M08C	●	●	25	25	150	32								
3232 P08C	●	●	32	32	170	40								

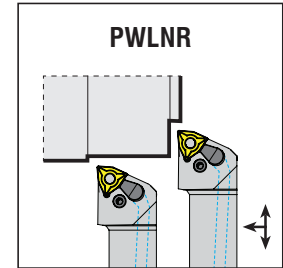
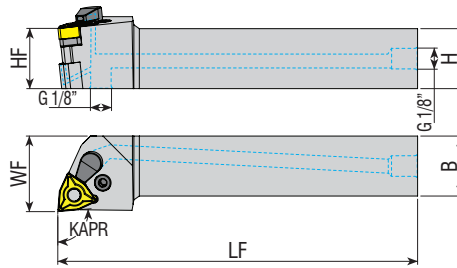

Takım Kodu Ordering Code Bestell-Bezeichnung	Stok Stock Lager		Takım Ölçüleri (mm) Dimension (mm) Abmessung (mm)				Kesici Uç Insert Wendeschneidplatte	Yedek Parçaları / Spare Parts / Ersatzteile									
	R	L	HF=H	B	LF	WF		Levye	Levye Vidası	Altlık	Altlık Yayı	Oring	Sızdırmaz Vida	Nozul	Anahtar		
								Lever	Lever Screw	Shim	Shim Spring	Ring	Threaded Pin	Spannpratze	İnnerschlüsselschlüssel		
PWNLR/L 2020 K08-H	●	●	20	20	125	25	WNM. 0804..	APL-02	ALV-03-M8x19	AAWN-3-0001	AAY-02	AXR-01	2705-G1/8x5.5	AN-01	AAL-03-3		
2525 M08-H	●	●	25	25	150	32										AOR-01	

R: Sağ / Right / Rechts L: Sol / Left / Links

● Stokta / In Stock / Auf Lager ○ Stokta Yok / Non Stock Item / Kein Lagerartikel, Lieferzeit auf Anfrage

Sipariş Örneği/Ordering Example/Bestellbeispiel

1 ad./pcs./stück PWNLR 1616 H06



KAPR=93°

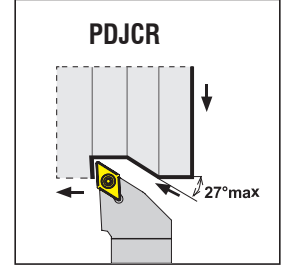
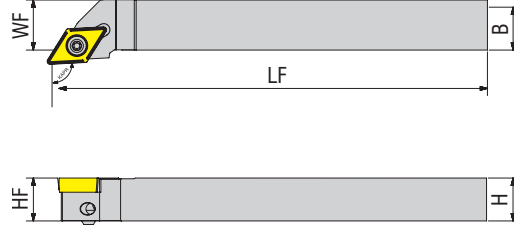

Takım Kodu Ordering Code Bestell-Bezeichnung	Stok Stock Lager		Takım Ölçüleri (mm) Dimension (mm) Abmessung (mm)				Kesici Uç Insert Wendeschneidplatte	Yedek Parçaları / Spare Parts / Ersatzteile							
	R	L	HF=H	B	LF	WF		Levyeye Lever Kniehebel	Levyeye Vidası Lever Screw Kniehebelschraube	Altılık Shim Unterlage	Altılık Yayını Shim Spring Feder für Unterlage	Baskı Parçası Wedge Clamp Spannpratze	Baskı Vidası Clamp Screw Klemmschraube	Anahtar Allen Key Innensechskantschlüssel	
PDJCR/L 1010 K11-S	●	○	10	10	125	10	DC.T 11T3..	APL-14	2802-M4x8	-	-	-	-	AAL-01-02	
1212 K11-S	●	○	12	12	125	12									APL-15
1616 K11-S	●	○	16	16	125	16									

R: Sağ / Right / Rechts L: Sol / Left / Links  
● Stokta / In Stock / Auf Lager ○ Stokta Yok / Non Stock Item / Kein Lagerartikel, Lieferzeit auf Anfrage  
ISO Uçuna Uygundur. / Compatible with ISO Insert. / Под пластину ISO Wendeplatten.

Sipariş Örneği/Ordering Example/Bestellbeispiel  
1 ad./pcs./stück PDJCR 1010 K11-S



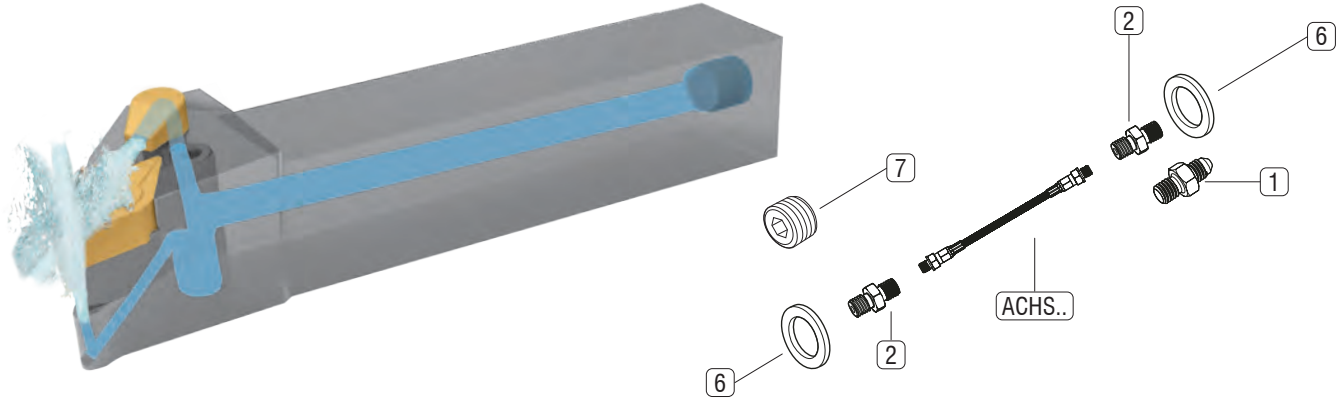

Not: İçten soğutmalı tüm torna katerlerinde kullanılabilir 3 tip soğutma hortum setleri tasarlanmıştır. Takımların kullanılmasından önce, kullanılmayan bağlantıların set içindeki vida ile kapatılarak sızdırmazlığın sağlanmasına dikkat edilmelidir. Torna katerlerine yönelik soğutma hortum setleri, ACHS... 10 bar ile maksimum 275 bar basınç aralığında kullanılabilir.

Note: 3 types of cooling hose sets are designed that can be used in all internally cooled lathes. Before using the tools, care should be taken to ensure that the unused connections are closed with the screw in the set and that sealing is ensured. Cooling hose sets for lathe tools can be used in the pressure range of ACHS ... 10 bar to max 275 bar.

Notiz: Es wurden 3 Arten von Kühlschlauch-Sets entwickelt, die in allen intern gekühlten Drehmaschinen verwendet werden können. Vor der Verwendung der Werkzeuge sollte darauf geachtet werden, dass die nicht verwendeten Verbindungen mit der Schraube im Satz geschlossen werden und die Abdichtung gewährleistet ist. Kühlschlauchsätze für Drehmaschinen können im Druckbereich von ACHS ... 10 bar bis max. 275 bar eingesetzt werden.

Set İçindeki Parçalar Parts In The Set Teile im Set				Uzunluk / Length Code / Länge		
Resim Picture Bild	Takım Kodu Set Code Code Einstellen	Ürün Açıklaması Product Description Artikelbeschreibung	Set Kodu: Set Code: Code Einstellen:	Set Kodu: Set Code: Code Einstellen:	Set Kodu: Set Code: Code Einstellen:	
			ACHS-1-250	ACHS-2-250	ACHS-3-250	
1	AMP-01	M10 Bağlantı Elemanı M10 Fastener M10 Verschluss	1x	-	-	
2	AMP-02	G 1/8" Çift Bağlantı Elemanı G 1/8" Double Fastener G 1/8" Doppelverschluss	2x	1x	-	
3	AMP-03	G 1/8" Açılı Bağlantısı G 1/8" Angle Connection G 1/8" Winkelverbindung	-	1x	2x	
4	AMP-04	M10" Açılı Bağlantısı M10" Angle Connection M10" Winkelverbindung	-	1x	1x	
5	AMP-05	G1/4"-G1/8" Kısılma Parçası G1/4"-G1/8" Capillary Piece G1/4"-G1/8" Kapillarstück	-	1x	1x	
6	AG-01	Bakır Conta Copper Gasket Kupferdichtung	2x	3x	4x	
7	2705-G1/8-5.5	G1/8" Sızdırmaz Civata G1/8" Sealing Bolt G1/8" Dichtungsschraube	1x	1x	1x	
8	AH-1-250	Hortum Hose Schlauch	1x	-	-	
9	AH-2-250	Hortum Hose Schlauch	-	1x	-	
10	AH-3-250	Hortum Hose Schlauch	-	-	1x	



*konuşulan  
the spoken kalite...  
quality...*

# C-SİSTEM

**C-SİSTEM DIŞ TORNA KATERLERİ**  
C-SYSTEM EXTERNAL TURNING TOOLHOLDERS  
C-SYSTEM AUSSEN - DREHHALTER



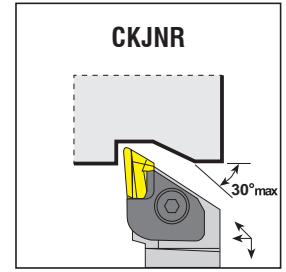
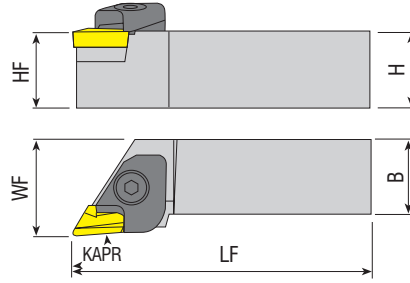

**Takım Kodu**  
**Ordering Code**  
**Bestell-Bezeichnung**

Takım Kodu Ordering Code Bestell-Bezeichnung	Stok Stock Lager		Takım Ölçüleri (mm) Dimension (mm) Abmessung (mm)				Kesici Uç Insert Wendeschneldplatte	Yedek Parçaları / Spare Parts / Ersatzteile						
	R	L	HF=H	B	LF	WF		Baskı Pabucu Wedge Clamp Spannpratze	Pabuç Vidası Clamp Screw Klemmschraube	Altlık Shim Unterlage	Altlık Vidası Shim Screw Schraube für Unterlage	Yay Spring Feder	Pul Stamp Ring	Anahtar Allen Key Innensechskantschlüssel
<b>CKJNR/L 2020 K16</b>	●	●	20	20	125	27.5	<b>KNUX 1604..</b>							
<b>2525 M16</b>	●	●	25	25	150	31.5								
<b>3232 P16</b>	●	●	32	32	170	40								
<b>4040 S16</b>	●	●	40	40	250	50								

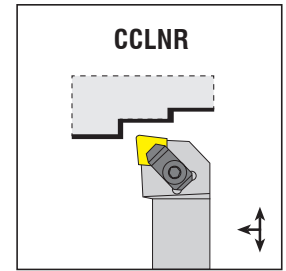
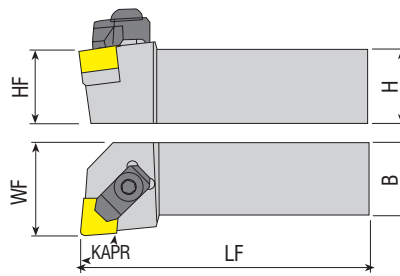
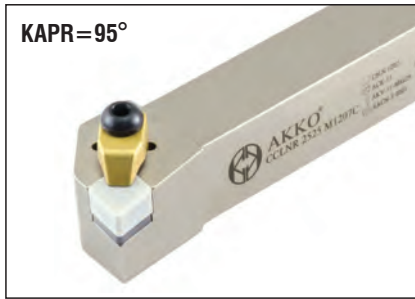

Takım Kodu Ordering Code Bestell-Bezeichnung	Stok Stock Lager		Takım Ölçüleri (mm) Dimension (mm) Abmessung (mm)				Kesici Uç Insert Wendeschneldplatte	Yedek Parçaları / Spare Parts / Ersatzteile					
	R	L	HF=H	B	LF	WF		Baskı Pabucu Wedge Clamp Spannpratze	Pabuç Vidası Clamp Screw Klemmschraube	Altlık Shim Unterlage	Altlık Vidası Shim Screw Schraube für Unterlage	Segman Ring Feder	Anahtar Allen Key Innensechskantschlüssel
<b>CCLNR/L 2525 M1207C</b>	●	●	25	25	150	32	<b>CN.N 1207..</b>						
<b>3232 P1207C</b>	●	●	32	32	170	40							
<b>2525 M1607C</b>	●	●	25	25	150	32	<b>CN.N 1607..</b>						

R: Sağ / Right / Rechts L: Sol / Left / Links

● Stokta / In Stock / Auf Lager ○ Stokta Yok / Non Stock Item / Kein Lagerartikel, Lieferzeit auf Anfrage

Sipariş Örneği/Ordering Example/Bestellbeispiel

1 ad./pcs./stück CKJNR 2020 K16

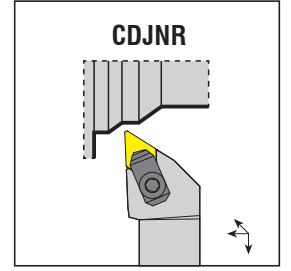
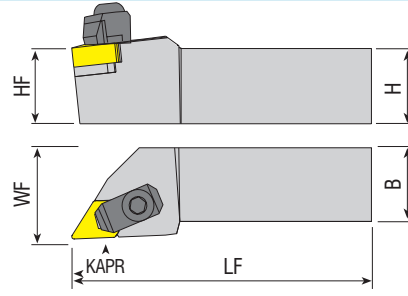

Takım Kodu Ordering Code Bestell-Bezeichnung	Stok Stock Lager		Takım Ölçüleri (mm) Dimension (mm) Abmessung (mm)				Kesici Uç Insert Wendeschneidplatte	Yedek Parçaları / Spare Parts / Ersatzteile					
	R	L	HF=H	B	LF	WF		Baskı Pabucu Wedge Clamp Spannpratze	Pabuç Vidası Clamp Screw Klemmschraube	Aitlik Shim Unterlage	Aitlik Vidası Shim Screw Schraube für Unterlage	Segman Ring Feder	Anahtar Allen Key Innensechskantschlüssel
CDJNR/L 2525 M1107C	●	●	25	25	150	32	DN.N 1107..	ACK-22	AKV-11-M8x29	AADN-2-0001	AAV-04-M5x12	ACS-01	AAL-05-4
2525 M1507C	●	●	25	25	150	32	DN.N 1507..	ACK-13	AKV-11-M8x29	AADN-3-0001	AAV-02-M5x12	ACS-01	AAL-05-4
3232 P1507C	●	●	32	32	170	40							

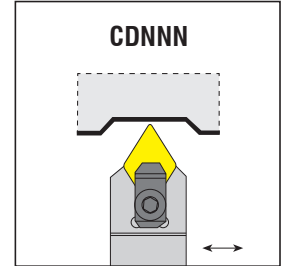
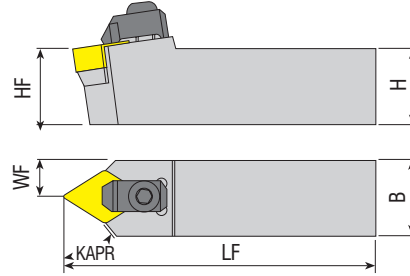

Takım Kodu Ordering Code Bestell-Bezeichnung	Stok Stock Lager		Takım Ölçüleri (mm) Dimension (mm) Abmessung (mm)				Kesici Uç Insert Wendeschneidplatte	Yedek Parçaları / Spare Parts / Ersatzteile					
			HF=H	B	LF	WF		Baskı Pabucu Wedge Clamp Spannpratze	Pabuç Vidası Clamp Screw Klemmschraube	Aitlik Shim Unterlage	Aitlik Vidası Shim Screw Schraube für Unterlage	Segman Ring Feder	Anahtar Allen Key Innensechskantschlüssel
CDNNN 2525 M1107C	●		25	25	150	12.5	DN.N 1107..	ACK-22	AKV-11-M8x29	AADN-2-0001	AAV-04-M5x12	ACS-01	AAL-05-4

R: Sağ / Right / Rechts L: Sol / Left / Links

● Stokta / In Stock / Auf Lager ○ Stokta Yok / Non Stock Item / Kein Lagerartikel, Lieferzeit auf Anfrage

Sipariş Örneği/Ordering Example/Bestellbeispiel

1 ad./pcs./stück CDJNR 2525 M1107C

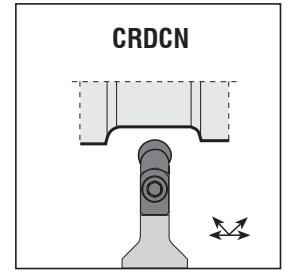
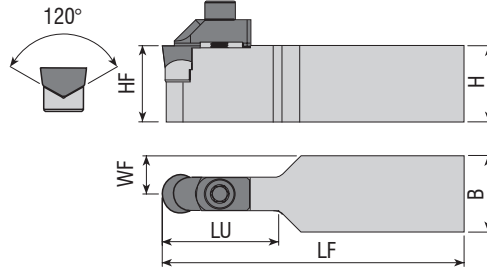

**Takım Kodu**  
**Ordering Code**  
**Bestell-Bezeichnung**

Stok Stock Lager	Takım Ölçüleri (mm) Dimension (mm) Abmessung (mm)					Kesici Uç Insert Wendeschnidplatte	Yedek Parçaları / Spare Parts / Ersatzteile				
	HF=H	B	LF	LU	WF		Baskı Pabucu Wedge Clamp Spannpratze	Pabuç Vidası Clamp Screw Klemmschraube	Altık Shim Unterlage	Altık Vidası Shim Screw Schraube für Unterlage	Anahtar Allen Key Innensechskantschlüssel
●	25	25	150	19	12.5	RCGX 0606..	ACK-27	2525-M3X14	AARC-3-0001	3007-M2.2X4.6	AAL-02-2.5
●	32	25	170	19	12.5						
●	40	40	250	19	20						
●	25	25	150	29	12.5	RCGX 0907..	ACK-28	2504-M5X16	AARC-3-0002	3008-M2.5x6	AAL-05-4
●	32	25	170	29	12.5						
●	40	40	250	29	20						
●	25	25	150	38	12.5	RCGX 1207..	ACK-29	2505-M6X20	AARC-3-0003	3008-M2.5x6	AAL-07-5
●	32	25	170	38	12.5						
●	40	40	250	38	20						

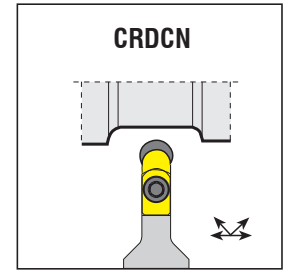
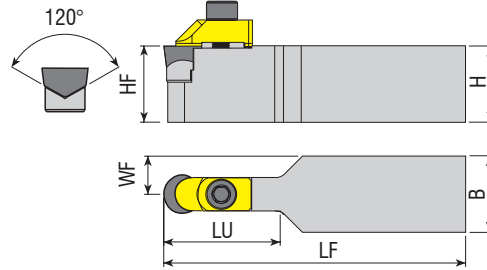

**Takım Kodu**  
**Ordering Code**  
**Bestell-Bezeichnung**

Stok Stock Lager	Takım Ölçüleri (mm) Dimension (mm) Abmessung (mm)					Kesici Uç Insert Wendeschnidplatte	Yedek Parçaları / Spare Parts / Ersatzteile				
	HF=H	B	LF	LU	WF		Baskı Pabucu Wedge Clamp Spannpratze	Pabuç Vidası Clamp Screw Klemmschraube	Altık Shim Unterlage	Altık Vidası Shim Screw Schraube für Unterlage	Anahtar Allen Key Innensechskantschlüssel
●	32	32	170	19	16	RCGX 060600	ACK-42	2525-M3x12	AARC-3-0005	2008-M2.5X12	AAL-02-2.5
●	40	40	200	19	20						
●	32	32	170	29	16						
●	40	40	200	29	20	RCGX 090700	ACK-43	2504-M5x14	AARC-3-0006	4015-M3.5x14	AAL-05-4
●	32	32	170	38	16						
●	40	40	200	38	20						
●	32	32	170	38	16	RCGX 120700	ACK-44	2505-M6x16	AARC-3-0007	1620-M5x18	AAL-07-5
●	40	40	200	38	20						

R: Sağ / Right / Rechts L: Sol / Left / Links

● Stokta / In Stock / Auf Lager ○ Stokta Yok / Non Stock Item / Kein Lagerartikel, Lieferzeit auf Anfrage

Sipariş Örneği/Ordering Example/Bestellbeispiel  
1 ad./pcs./stück CRDCN 2525 M06CV

**C-SİSTEM SERAMİK UÇLAR İÇİN DIŞ TORNA KATERLERİ**  
**C-SYSTEM EXTERNAL TURNING TOOLHOLDERS FOR CERAMIC INSERTS**  
**C-SYSTEM AUSSEN - DREHHALTER FÜR KERAMIK WENDESCHNEIDPLATTEN**

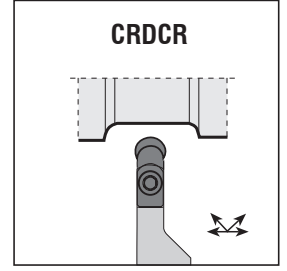
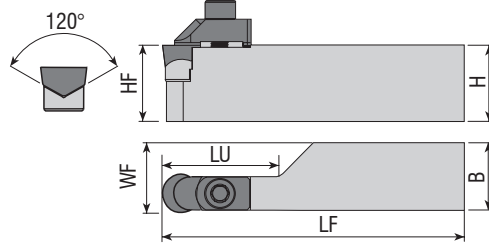

**Takım Kodu**  
**Ordering Code**  
*Bestell-Bezeichnung*

Stok Stock Lager	Takım Ölçüleri (mm) Dimension (mm) Abmessung (mm)						Kesici Uç Insert Wendeschneidplatte	Yedek Parçaları / Spare Parts / Ersatzteile					
	R	L	HF=H	B	LF	LU		WF	Baskı Pabucu Wedge Clamp Spannpratze	Pabuç Vidası Clamp Screw Klemmschraube	Altlık Shim Unterlage	Altlık Vidası Shim Screw Schraube für Unterlage	Anahtar Allen Key Innensechskantschlüssel
●	●	32	25	170	19.4	25.6	<b>RCGX 0606..</b>	ACK-27	2525-M3X14	AARC-3-0001	3007-M2.2X4.6	AAL-02-2.5	
●	●	32	25	170	29	25.8	<b>RCGX 0907..</b>	ACK-28	2504-M5X16	AARC-3-0002	3008-M2.5x6	AAL-05-4	
●	●	32	25	170	38.5	25.9	<b>RCGX 1207..</b>	ACK-29	2505-M6X20	AARC-3-0003	3008-M2.5x6	AAL-07-5	

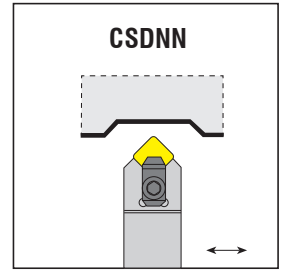
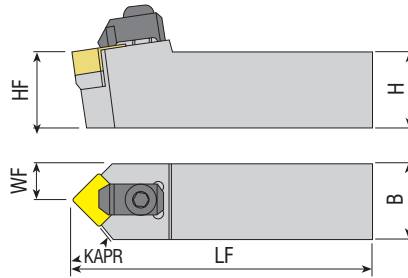

**Takım Kodu**  
**Ordering Code**  
*Bestell-Bezeichnung*

Stok Stock Lager	Takım Ölçüleri (mm) Dimension (mm) Abmessung (mm)					Kesici Uç Insert Wendeschneidplatte	Yedek Parçaları / Spare Parts / Ersatzteile					
	HF=H	B	LF	WF	WF		Baskı Pabucu Wedge Clamp Spannpratze	Pabuç Vidası Clamp Screw Klemmschraube	Altlık Shim Unterlage	Altlık Vidası Shim Screw Schraube für Unterlage	Segman Ring Feder	Anahtar Allen Key Innensechskantschlüssel
●	25	25	150	12.5		<b>SN.N 1207..</b>	ACK-13	AKV-11-M8x29	AASN-3-0004	AAV-02-M5x12	ACS-01	AAL-05-4
●	32	32	170	16								

R: Sağ / Right / Rechts L: Sol / Left / Links

● Stokta / In Stock / Auf Lager ○ Stokta Yok / Non Stock Item / Kein Lagerartikel, Lieferzeit auf Anfrage

Sipariş Örneği/Ordering Example/Bestellbeispiel

1 ad./pcs./stück CRDCR 3225 P06CV



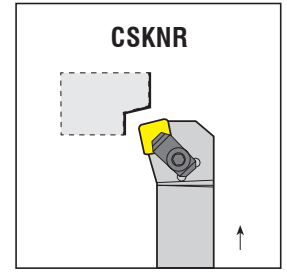
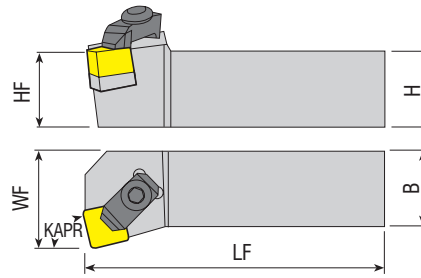
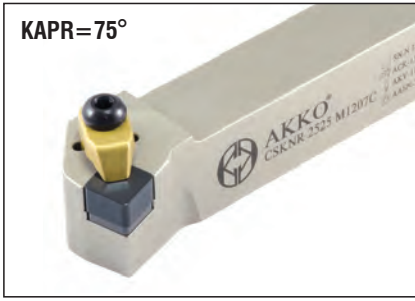

Takım Kodu Ordering Code Bestell-Bezeichnung	Stok Stock Lager		Takım Ölçüleri (mm) Dimension (mm) Abmessung (mm)				Kesici Uç Insert Wendeschneidplatte	Yedek Parçaları / Spare Parts / Ersatzteile					
	R	L	HF=H	B	LF	WF		Baskı Pabucu Wedge Clamp Spannpratze	Pabuç Vidası Clamp Screw Klemmschraube	Altlık Shim Unterlage	Altlık Vidası Shim Screw Schraube für Unterlage	Segman Ring Feder	Anahtar Allen Key Innenschraubenschlüssel
CSKNR/L 2525 M1207C 3232 P1207C	●	●	25	25	150	32	SN.N 1207..	ACK-13	AKV-11-M8x29	AASN-3-0004	AAV-02-M5x12	ACS-01	AAL-05-4
	●	●	32	32	170	40							

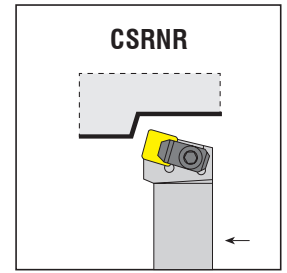
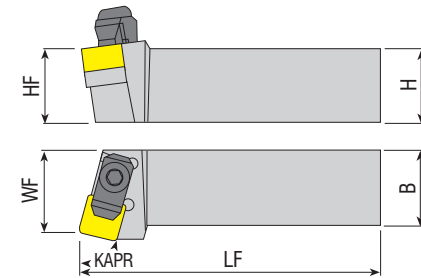

Takım Kodu Ordering Code Bestell-Bezeichnung	Stok Stock Lager		Takım Ölçüleri (mm) Dimension (mm) Abmessung (mm)				Kesici Uç Insert Wendeschneidplatte	Yedek Parçaları / Spare Parts / Ersatzteile					
	R	L	HF=H	B	LF	WF		Baskı Pabucu Wedge Clamp Spannpratze	Pabuç Vidası Clamp Screw Klemmschraube	Altlık Shim Unterlage	Altlık Vidası Shim Screw Schraube für Unterlage	Segman Ring Feder	Anahtar Allen Key Innenschraubenschlüssel
CSRNR/L 2525 M1207C 3232 P1207C	●	●	25	25	150	32	SN.N 1207..	ACK-13	AKV-11-M8x29	AASN-3-0004	AAV-02-M5x12	ACS-01	AAL-05-4
	●	●	32	32	170	40							

R: Sağ / Right / Rechts L: Sol / Left / Links

● Stokta / In Stock / Auf Lager ○ Stokta Yok / Non Stock Item / Kein Lagerartikel, Lieferzeit auf Anfrage

Sipariş Örneği/Ordering Example/Bestellbeispiel

1 ad./pcs./stück CSKNR 2525 M1207C

**C-SİSTEM SERAMİK UÇLAR İÇİN DİŞ TORNA KATERLERİ**  
**C-SYSTEM EXTERNAL TURNING TOOLHOLDERS FOR CERAMIC INSERTS**  
**C-SYSTEM AUSSEN - DREHHALTER FÜR KERAMIK WENDESCHNEIDPLATTEN**

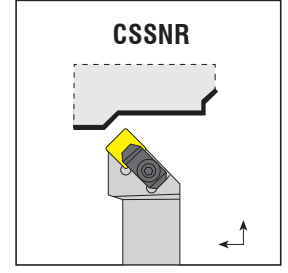
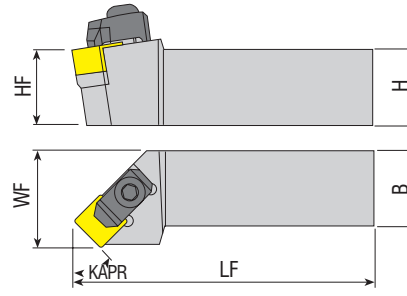

Takım Kodu Ordering Code Bestell-Bezeichnung	Stok Stock Lager		Takım Ölçüleri (mm) Dimension (mm) Abmessung (mm)				Kesici Uç Insert Wendescheidplatte	Yedek Parçaları / Spare Parts / Ersatzteile					
	R	L	HF=H	B	LF	WF		Baskı Pabucu Wedge Clamp Spannpratze	Pabuç Vidası Clamp Screw Klemmschraube	Altlık Shim Unterlage	Altlık Vidası Shim Screw Schraube für Unterlage	Segman Ring Feder	Anahtar Allen Key Innensechskantschlüssel
CSSNR/L 2525 M1207C	●	●	25	25	150	32	SN.N 1207..	ACK-13	AKV-11-M8x29	AASN-3-0004	AAV-02-M5x12	ACS-01	AAL-05-4
3232 P1207C	●	●	32	32	170	40							

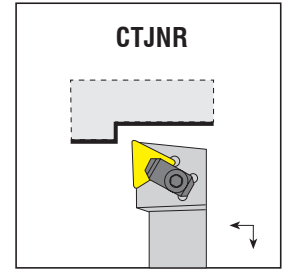
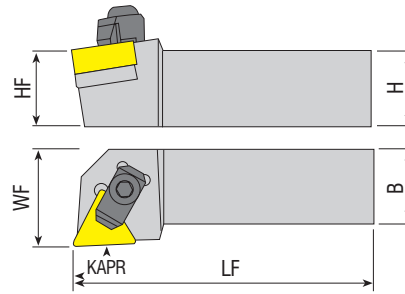

Takım Kodu Ordering Code Bestell-Bezeichnung	Stok Stock Lager		Takım Ölçüleri (mm) Dimension (mm) Abmessung (mm)				Kesici Uç Insert Wendescheidplatte	Yedek Parçaları / Spare Parts / Ersatzteile					
	R	L	HF=H	B	LF	WF		Baskı Pabucu Wedge Clamp Spannpratze	Pabuç Vidası Clamp Screw Klemmschraube	Altlık Shim Unterlage	Altlık Vidası Shim Screw Schraube für Unterlage	Segman Ring Feder	Anahtar Allen Key Innensechskantschlüssel
CTJNR/L 2525 M1607C	●	●	25	25	150	32	TN.N 1607..	ACK-14	AKV-11-M8x29	AATN-2-0002	AAV-03-M5x12	ACS-01	AAL-05-4
3232 P1607C	○	○	32	32	170	40							

R: Sağ / Right / Rechts L: Sol / Left / Links

● Stokta / In Stock / Auf Lager ○ Stokta Yok / Non Stock Item / Kein Lagerartikel, Lieferzeit auf Anfrage

Sipariş Örneği/Ordering Example/Bestellbeispiel

1 ad./pcs./stück CSSNR 2525 M1207C

# S-SİSTEM

**S-SİSTEM DIŞ TORNA KATERLERİ**  
S-SYSTEM EXTERNAL TURNING TOOLHOLDERS  
S-SYSTEM AUSSEN - DREHHALTER

*konusulan  
the spoken kalite...  
quality...*



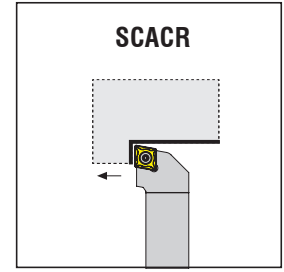
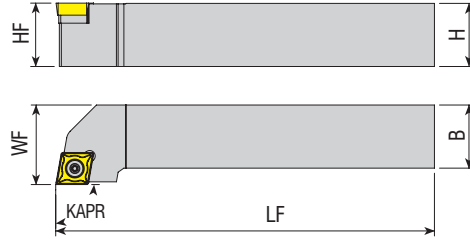
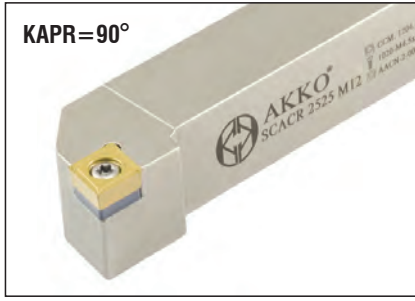

Takım Kodu Ordering Code Bestell-Bezeichnung	Stok Stock Lager		Takım Ölçüleri (mm) Dimension (mm) Abmessung (mm)				Kesici Uç Insert Wendeschneidplatte	Yedek Parçaları / Spare Parts / Ersatzteile			
	R	L	HF=H	B	LF	WF		Sıkma Vidası Screw Klemmschraube	Altlık Shim Unterlage	Altlık Vidası Shim Screw Schraube für Unterlage	Tork Anahtar Torx Key Torx-Schlüssel
SCACR/L 0808 E06	●	●	08	08	70	10	CCM. 0602..	4008-M2.5x6	-	-	82-T08
1010 E06	●	●	10	10	70	12		4015-M3.5x11	-	-	
1212 F09	●	●	12	12	80	16		4015-M3.5x14	AACN-2-0001	AAV-06-M3.5x11	
1616 H09	●	●	16	16	100	20	CC.T 09T3..	AACN-2-0001	AAV-06-M3.5x11		
2020 K09	●	●	20	20	125	25				CC.T 1204..	AACN-2-0003
2020 K12	●	●	20	20	125	25					
2525 M12	●	●	25	25	150	32					

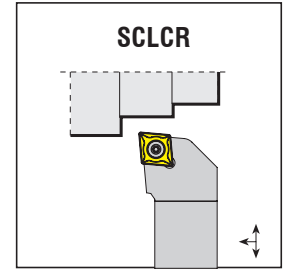
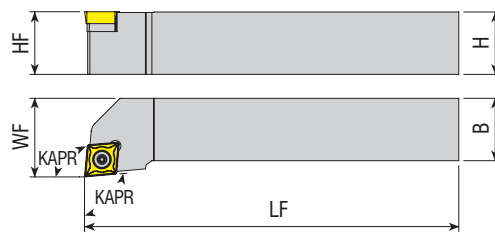
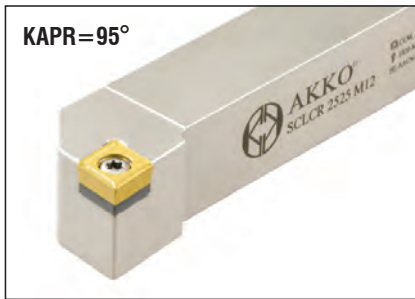

Takım Kodu Ordering Code Bestell-Bezeichnung	Stok Stock Lager		Takım Ölçüleri (mm) Dimension (mm) Abmessung (mm)				Kesici Uç Insert Wendeschneidplatte	Yedek Parçaları / Spare Parts / Ersatzteile			
	R	L	HF=H	B	LF	WF		Sıkma Vidası Screw Klemmschraube	Altlık Shim Unterlage	Altlık Vidası Shim Screw Schraube für Unterlage	Tork Anahtar Torx Key Torx-Schlüssel
SCLCR/L 0808 E06	●	●	08	08	70	10	CCM. 0602..	4008-M2.5x6	-	-	82-T08
1010 E06	●	○	10	10	70	12		4015-M3.5x9	-	-	
1212 F06	●	●	12	12	80	16		4015-M3.5x11	-	-	
1010 E09	●	●	10	10	70	12	CC.T 09T3..	AACN-2-0001	AAV-06-M3.5x11	80-T15	
1212 F09	●	●	12	12	80	16					
1616 H09	●	●	16	16	100	20					
2020 K09	●	●	20	20	125	25	CC.T 1204..	AACN-2-0003	AAV-07-M4.5x13	80-T20	
2525 M09	●	●	25	25	150	32					
1616 H12	●	○	16	16	100	20					
2020 K12	●	●	20	20	125	25	CC.T 1204..	AACN-2-0003	AAV-07-M4.5x13	80-T20	
2525 M12	●	●	25	25	150	32					

R: Sağ / Right / Rechts L: Sol / Left / Links  
● Stokta / In Stock / Auf Lager ○ Stokta Yok / Non Stock Item / Kein Lagerartikel, Lieferzeit auf Anfrage

Sipariş Örneği/Ordering Example/Bestellbeispiel  
1 ad./pcs./stück SCACR 0808 E06

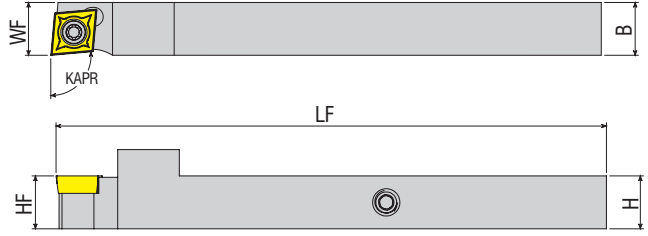

Takım Kodu Ordering Code Bestell-Bezeichnung	Stok Stock Lager		Takım Ölçüleri (mm) Dimension (mm) Abmessung (mm)				Kesici Uç Insert Wendeschneidplatte	Yedek Parçaları / Spare Parts / Ersatzteile					
	R	L	HF=H	B	LF	WF		Sıkma Vidası Screw Klemmschraube	Altılık Shim Unterlage	Altılık Vidası Shim Screw Schraube für Unterlage	Sızdırmaz Vida Threaded Pin Gewindestift	Anahtar Allen Key Innensechskantschlüssel	Tork Anahtar Torx Key Torx-Schlüssel
SCLCR/L 1212 K09-SHP	●	○	12	12	125	12	CC.T 09T3..	4015-M3.5x11	-	-	2703-M6X4	AAL-03-3	80-T15
1616 K09-SHP	●	○	16	16	125	16					2704-M8X1X5	AAL-05-4	

ISO Ucuna Uygunur. / Compatible with ISO Insert. / Kompatibel mit ISO Wendepplatten.

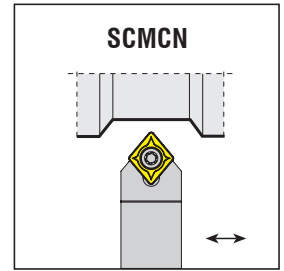
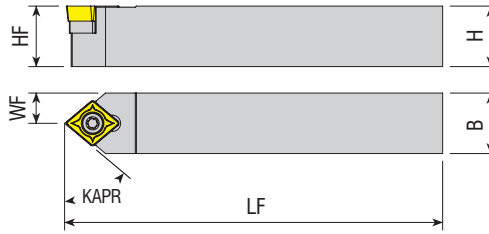
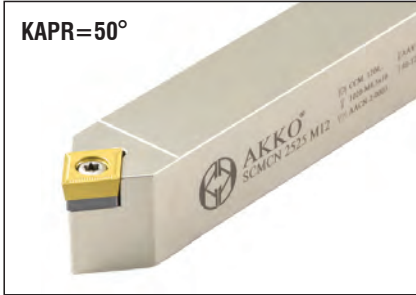

Takım Kodu Ordering Code Bestell-Bezeichnung	Stok Stock Lager		Takım Ölçüleri (mm) Dimension (mm) Abmessung (mm)				Kesici Uç Insert Wendeschneidplatte	Yedek Parçaları / Spare Parts / Ersatzteile				
			HF=H	B	LF	WF		Sıkma Vidası Screw Klemmschraube	Altılık Shim Unterlage	Altılık Vidası Shim Screw Schraube für Unterlage	Tork Anahtar Torx Key Torx-Schlüssel	
SCMCN 0808 E06	●		08	08	70	04	CCM. 0602..	4008-M2.5x6	-	-	82-T08	
1010 E06	●		10	10	70	05						
1212 F06	●		12	12	80	06						
1212 F09	●		12	12	80	06	CC.T 09T3..	4015-M3.5x11	-	-	80-T15	
1616 H09	●		16	16	100	08						4015-M3.5x14
2020 K12	●		20	20	125	10	CC.T 1204..	1020-M4.5x16	AACN-2-0003	AAV-07-M4.5x13	80-T20	
2525 M12	●		25	25	150	12.5						

R: Sağ / Right / Rechts L: Sol / Left / Links

● Stokta / In Stock / Auf Lager ○ Stokta Yok / Non Stock Item / Kein Lagerartikel, Lieferzeit auf Anfrage

Sipariş Örneği/Ordering Example/Bestellbeispiel  
1 ad./pcs./stück SCLCR/L 1212 K09-SHP

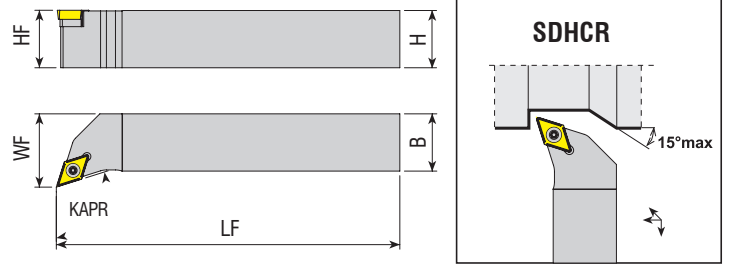
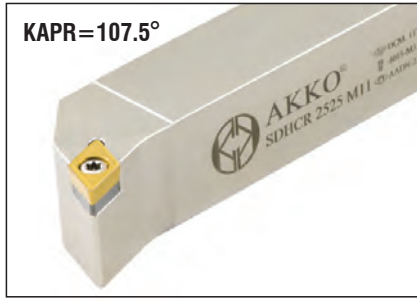

Takım Kodu Ordering Code Bestell-Bezeichnung	Stok Stock Lager		Takım Ölçüleri (mm) Dimension (mm) Abmessung (mm)				Kesici Uç Insert Wendeschneidplatte	Yedek Parçaları / Spare Parts / Ersatzteile				
	R	L	HF=H	B	LF	WF		Sıkma Vidası Screw Klemmschraube	Altılık Shim Unterlage	Altılık Vidası Shim Screw Schraube für Unterlage	Tork Anahtar Torx Key Torx-Schlüssel	
SDHCR/L 0808 E07	●	●	08	08	70	11	DC.T 0702..	4008-M2.5x6	-	-	82-T08	
1010 E07	●	●	10	10	70	12						
1212 F07	●	●	12	12	80	16						
1616 H07	●	●	16	16	100	20						
1616 H11	●	●	16	16	100	20						
2020 K11	●	●	20	20	125	25	DC.T 11T3..	4015-M3.5x14	AADN-2-0001	AAV-06-M3.5x11	80-T15	
2525 M11	●	●	25	25	150	32						
3232 P11	●	●	32	32	170	40						

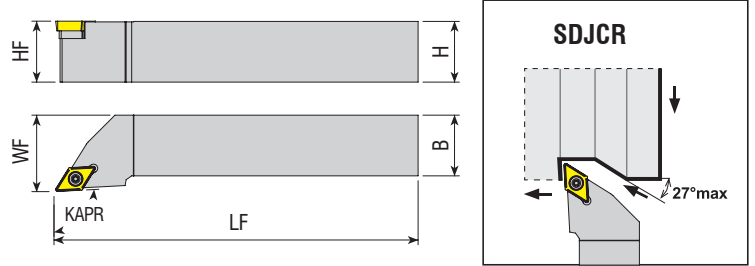
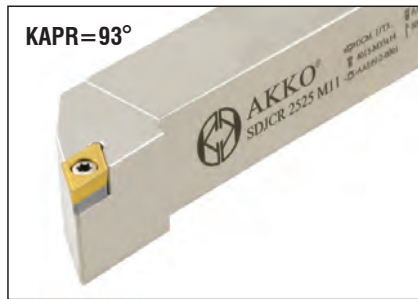

Takım Kodu Ordering Code Bestell-Bezeichnung	Stok Stock Lager		Takım Ölçüleri (mm) Dimension (mm) Abmessung (mm)				Kesici Uç Insert Wendeschneidplatte	Yedek Parçaları / Spare Parts / Ersatzteile				
	R	L	HF=H	B	LF	WF		Sıkma Vidası Screw Klemmschraube	Altılık Shim Unterlage	Altılık Vidası Shim Screw Schraube für Unterlage	Tork Anahtar Torx Key Torx-Schlüssel	
SDJCR/L 0808 E07	●	●	08	08	70	10	DC.T 0702..	4008-M2.5x6	-	-	82-T08	
1010 E07	●	●	10	10	70	12						
1212 F07	●	●	12	12	80	16						
1616 H07	●	●	16	16	100	20						
1212 F11	●	●	12	12	80	16						
1616 H11	●	●	16	16	100	20	DC.T 11T3..	4015-M3.5x14	AADN-2-0001	AAV-06-M3.5x11	80-T15	
2020 K11	●	●	20	20	125	25						
2525 M11	●	●	25	25	150	32						
3232 P11	●	●	32	32	170	40						

R: Sağ / Right / Rechts L: Sol / Left / Links

● Stokta / In Stock / Auf Lager ○ Stokta Yok / Non Stock Item / Kein Lagerartikel, Lieferzeit auf Anfrage

Sipariş Örneği/Ordering Example/Bestellbeispiel  
1 ad./pcs./stück SDHCR 0808 E07



KAPR=93°

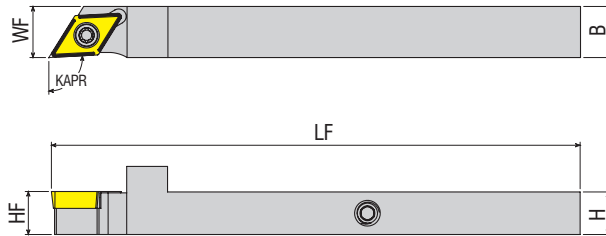

Takım Kodu Ordering Code Bestell-Bezeichnung	Stok Stock Lager		Takım Ölçüleri (mm) Dimension (mm) Abmessung (mm)				Kesici Uç Insert Wendeschneidplatte	Yedek Parçaları / Spare Parts / Ersatzteile						
	R	L	HF=H	B	LF	WF		Sıkma Vidası Screw Klemmschraube	Altılık Shim Unterlage	Altılık Vidası Shim Screw Schraube für Unterlage	Sızdırmaz Vida Threaded Pin Gewindestift	Anahtar Allen Key Inmenschenschlüssel	Tork Anahtar Torx Key Torx-Schlüssel	
	●	○												
SDJCR/L 0810 G07-SHP	●	○	8	10	90	10	DC.T 0702..	4008-M2.5x6					82-T08	
1010 K07-SHP	●	○	10	10	125	10								
1012 K11-SHP	●	○	10	12	125	12	DC.T 11T3..	4015-M3.5x14	-	-	2703-M6X4	AAL-03-3	80-T15	
1212 K11-SHP	●	○	12	12	125	12					2704-M8X1X5	AAL-05-4		
1616 K11-SHP	●	○	16	16	125	16								

ISO Ucuna Uygundur. / Compatible with ISO Insert. / Kompatibel mit ISO Wendepfatten.

KAPR=62.5°

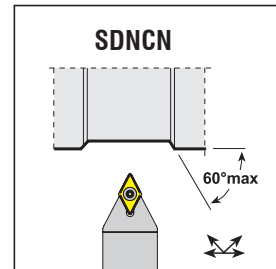
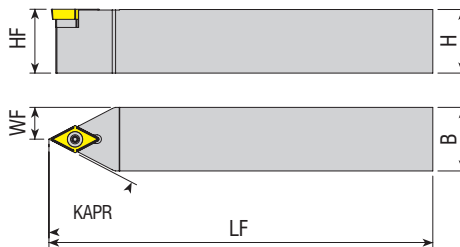
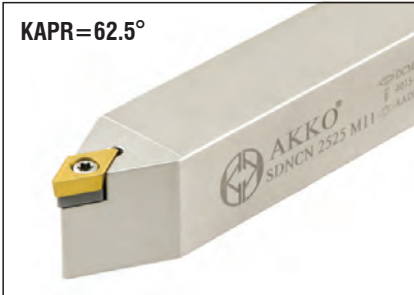

Takım Kodu Ordering Code Bestell-Bezeichnung	Stok Stock Lager		Takım Ölçüleri (mm) Dimension (mm) Abmessung (mm)				Kesici Uç Insert Wendeschneidplatte	Yedek Parçaları / Spare Parts / Ersatzteile				
			HF=H	B	LF	WF		Sıkma Vidası Screw Klemmschraube	Altılık Shim Unterlage	Altılık Vidası Shim Screw Schraube für Unterlage	Tork Anahtar Torx Key Torx-Schlüssel	
	●	○										
SDNCR 0808 E07	●	○	08	08	70	4	DC.T 0702..	4008-M2.5x6	-	-	82-T08	
1010 E07	●	○	10	10	70	5						
1212 F07	●	○	12	12	80	6						
1616 H07	●	○	16	16	100	8	DC.T 11T3..	4015-M3.5x14	AADN-2-0001	AAV-06-M3.5x11	80-T15	
1616 H11	●	○	16	16	100	8						
2020 K11	●	○	20	20	125	10						
2525 M11	●	○	25	25	150	12.5						
3232 P11	●	○	32	32	170	16						

R: Sağ / Right / Rechts L: Sol / Left / Links

● Stokta / In Stock / Auf Lager ○ Stokta Yok / Non Stock Item / Kein Lagerartikel, Lieferzeit auf Anfrage

Sipariş Örneği/Ordering Example/Bestellbeispiel  
1 ad./pcs./stück SDJCR/L 0810 G07-SHP

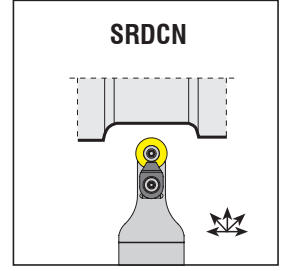
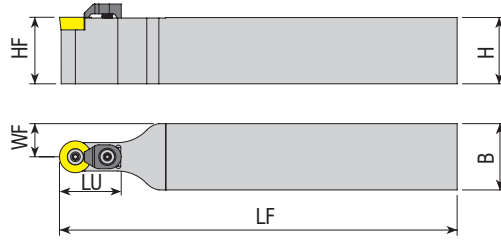

**Takım Kodu**  
**Ordering Code**  
*Bestell-Bezeichnung*

Stok  
Stock  
Lager

Takım Ölçüleri (mm)  
Dimension (mm)  
Abmessung (mm)

Kesici Uç  
Insert  
Wendeschneidplatte

Sıkma Vidası  
Screw  
Klemmschraube

Altlık  
Shim  
Unterlage

Altlık Vidası  
Shim Screw  
Schraube für Unterlage

Baskı Parçası  
Wedge Clamp  
Spannpratze

Baskı Vidası  
Clamp Screw  
Klemmschraube

Tork Anahtar  
Torx Key  
Torx-Schlüssel

Yedek Parçaları / Spare Parts / Ersatzteile

Takım Kodu Ordering Code Bestell-Bezeichnung	Stok Stock Lager	Takım Ölçüleri (mm) Dimension (mm) Abmessung (mm)					Kesici Uç Insert Wendeschneidplatte	Sıkma Vidası Screw Klemmschraube	Altlık Shim Unterlage	Altlık Vidası Shim Screw Schraube für Unterlage	Baskı Parçası Wedge Clamp Spannpratze	Baskı Vidası Clamp Screw Klemmschraube	Tork Anahtar Torx Key Torx-Schlüssel
		HF=H	B	LF	LU	WF							
SRDCN 1616 H06	●	16	16	100	15	8							
2020 K06	●	20	20	125	17	10	RC.T 0602..	3008-M2.5x6	-	-	-	-	
2525 M06	●	25	25	150	17	12.5							82-T08
1616 H08C	●	16	16	100	15	8							
2020 K08C	●	20	20	125	20	10	RC.T 0803..	3008-M3x8	-	-			
2525 M08C	●	25	25	150	20	12.5							
1616 H10C	●	16	16	100	20	8					ACK-15	4015-M3.5x11	
2020 K10C	●	20	20	125	20	10							
2525 M10C	●	25	25	150	20	12.5	RC.T 10T3..	4015-M3.5x11	-	-			
3232 P10C	●	32	32	170	20	16							
2020 K12C	●	20	20	125	22	10							80-T15
2525 M12C	●	25	25	150	22	12.5	RC.T 1204..	4015-M3.5x11	-	-			
3232 P12C	●	32	32	170	22	16							
2525 M16C	●	25	25	150	32	12.5					ACK-05	4015-M4x11	
3232 P16C	●	32	32	170	35	16	RC.T 1605..	1020-M5x11	-	-			
2525 M20C	●	25	25	150	32	12.5							80-T20
3232 P20C	●	32	32	170	40	16	RC.T 2006..	1420-M6x16	-	-			
3232 P25C	●	32	32	170	40	16	RC.T 2507..	1520-M6x16	-	-	ACK-09	AAV-05-M6x15	
3232 P32C	●	32	32	170	45	16	RC.T 3209..	1904-M8x1x20	-	-			AAL-05-4

R: Sağ / Right / Rechts L: Sol / Left / Links

● Stokta / In Stock / Auf Lager ○ Stokta Yok / Non Stock Item / Kein Lagerartikel, Lieferzeit auf Anfrage

Sipariş Örneği/Ordering Example/Bestellbeispiel

1 ad./pcs./stück SRDCN 1616 H06





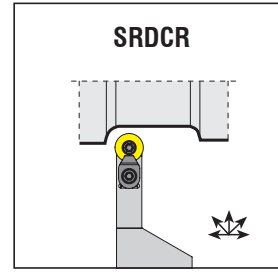
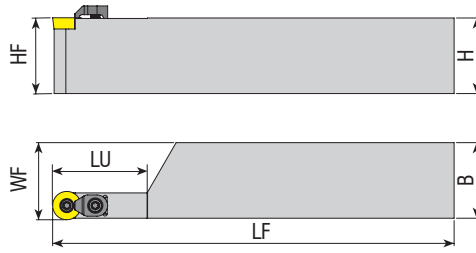

**Takım Kodu**  
**Ordering Code**  
**Bestell-Bezeichnung**

Stok Stock Lager	Takım Ölçüleri (mm) Dimension (mm) Abmessung (mm)						Kesici Uç Insert Wendeschneidplatte	Yedek Parçaları / Spare Parts / Ersatzteile						
	R	L	HF=H	B	LF	LU		WF	Sıkma Vidası Screw Klemmschraube	Altlık Shim Unterlage	Altlık Vidası Shim Screw Schraube für Unterlage	Baskı Parçası Wedge Clamp Spannpratze	Baskı Vidası Clamp Screw Klemmschraube	Tork Anahtar Torx Key Torx-Schlüssel
SRDCR/L 3232 T06	●	●	32	32	300	20	32.35	RC.T 0602..	3008-M2.5x6	-	-	-	-	82-T08
3232 P12C	●	●	32	32	170	40	32.65	RC.T 1204..	4015-M3.5x11	-	-	ACK-05	4015-M4x11	80-T15

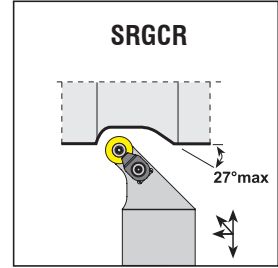
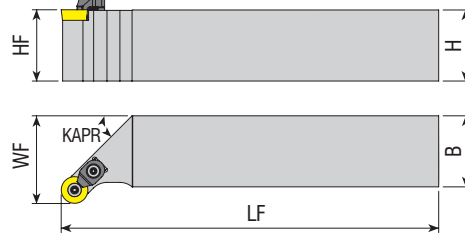

**Takım Kodu**  
**Ordering Code**  
**Bestell-Bezeichnung**

Stok Stock Lager	Takım Ölçüleri (mm) Dimension (mm) Abmessung (mm)						Kesici Uç Insert Wendeschneidplatte	Yedek Parçaları / Spare Parts / Ersatzteile						
	R	L	HF=H	B	LF	WF		Sıkma Vidası Screw Klemmschraube	Altlık Shim Unterlage	Altlık Vidası Shim Screw Schraube für Unterlage	Baskı Parçası Wedge Clamp Spannpratze	Baskı Vidası Clamp Screw Klemmschraube	Tork Anahtar Torx Key Torx-Schlüssel	
SRGCR/L 1616 H06	●	●	16	16	100	20	RC.T 0602..	3008-M2.5x6	-	-	-	-	82-T08	
2020 K06	●	●	20	20	125	25								
1616 H08C	●	●	16	16	100	20	RC.T 0803..	3008-M3x8	-	-	ACK-15	4015-M3.5x11	80-T15	
2020 K08C	●	●	20	20	125	25								
2525 M08C	●	●	25	25	150	32	RC.T 10T3..	4015-M3.5x11	-	-	ACK-05	4015-M4x11	80-T15	
1616 H10C	●	●	16	16	100	20								
2020 K10C	●	●	20	20	125	25								
2525 M10C	●	●	25	25	150	32								
3232 P10C	●	●	32	32	170	40	RC.T 1204..	4015-M3.5x11	-	-	ACK-05	4015-M4x11	80-T15	
2020 K12C	●	●	20	20	125	25								
2525 M12C	●	●	25	25	150	32								
3232 P12C	●	●	32	32	170	40								

R: Sağ / Right / Rechts L: Sol / Left / Links

● Stokta / In Stock / Auf Lager ○ Stokta Yok / Non Stock Item / Kein Lagerartikel, Lieferzeit auf Anfrage

Sipariş Örneği/Ordering Example/Bestellbeispiel

1 ad./pcs./stück SRDCR 3232 T06

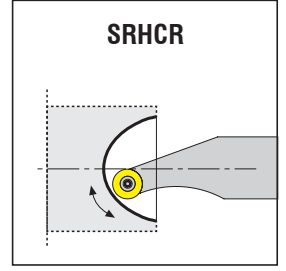
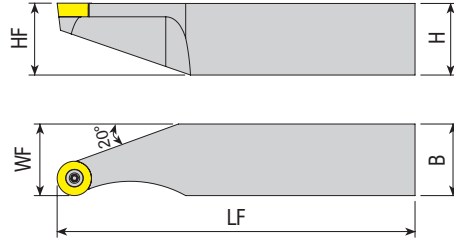

Takım Kodu Ordering Code Bestell-Bezeichnung	Stok Stock Lager		Takım Ölçüleri (mm) Dimension (mm) Abmessung (mm)					Kesici Uç Insert Wendeschneidplatte	Yedek Parçaları / Spare Parts / Ersatzteile				
	R	L	HF=H	B	LF	WF	MIN R		Sıkma Vidası Screw Klemmschraube	Altlık Shim Unterlage	Altlık Vidası Shim Screw Schraube für Unterlage	Tork Anahtar Torx Key Torx-Schlüssel	
SRHCR/L 2525 K06	●	○	25	25	125	25	32.5	RC.T 0602..	3008-M2.5x6	-	-	82-T08	
2525 K08	●	●	25	25	125	25	32.5	RC.T 0803..	3008-M3x8	-	-		
2525 K10	●	●	25	25	125	25	36	RC.T 10T3..	4015-M3.5x11	-	-	80-T15	
2525 K12	●	●	25	25	125	25	40	RC.T 1204..					
2525 K16	●	●	25	25	125	25	47.5	RC.T 1606..	1020-M5x11	-	-	80-T20	

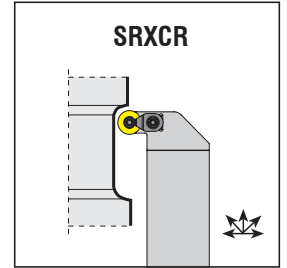
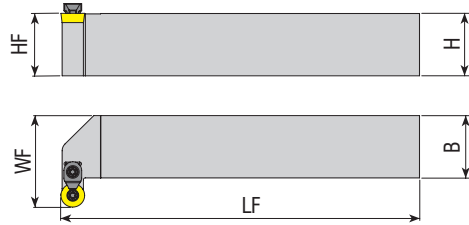

Takım Kodu Ordering Code Bestell-Bezeichnung	Stok Stock Lager		Takım Ölçüleri (mm) Dimension (mm) Abmessung (mm)				Kesici Uç Insert Wendeschneidplatte	Sıkma Vidası Screw Klemmschraube	Altlık Shim Unterlage	Altlık Vidası Shim Screw Schraube für Unterlage	Baskı Parçası Wedge Clamp Spannpratze	Baskı Vidası Clamp Screw Klemmschraube	Tork Anahtar Torx Key Torx-Schlüssel
	R	L	HF=H	B	LF	WF							
SRXCR/L 3232 X08C	●	●	32	32	220	47	RC.T 0803..	3008-M3x8			ACK-15	4015-M3.5x11	82-T08
3232 X10C	●	●	32	32	220	47	RC.T 10T3..	4015-M3.5x11					80-T15
3232 X12C	●	●	32	32	220	47	RC.T 1204..				ACK-05	4015-M4x11	

R: Sağ / Right / Rechts L: Sol / Left / Links

● Stokta / In Stock / Auf Lager ○ Stokta Yok / Non Stock Item / Kein Lagerartikel, Lieferzeit auf Anfrage

Sipariş Örneği/Ordering Example/Bestellbeispiel

1 ad./pcs./stück SRHCR 2525 K06

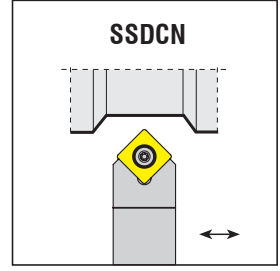
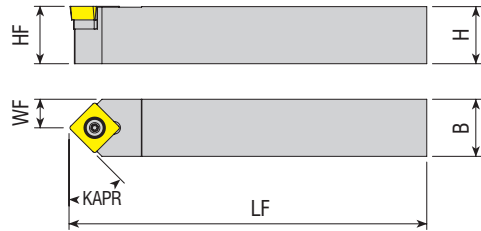

Takım Kodu Ordering Code Bestell-Bezeichnung	Stok Stock Lager		Takım Ölçüleri (mm) Dimension (mm) Abmessung (mm)				Kesici Uç Insert Wendeschneidplatte	Yedek Parçaları / Spare Parts / Ersatzteile			
	R	L	HF=H	B	LF	WF		Sıkma Vidası Screw Klemmschraube	Altlık Shim Unterlage	Altlık Vidası Shim Screw Schraube für Unterlage	Tork Anahtar Torx Key Torx-Schlüssel
<b>SSDCN 1212 F09</b>	●		12	12	80	6	<b>SC.T 09T3..</b>	4015-M3.5x11	-	-	80-T15
<b>1616 H09</b>	●		16	16	100	8		4015-M3.5x14	AASN-2-0001	AAV-06-M3.5x11	
<b>2020 K09</b>	●		20	20	125	10		4020-M4.5x12		AAV-10-M4.5x8	
<b>1616 H12</b>	●		16	16	100	8	<b>SC.T 1204..</b>	1020-M4.5x16	AASN-2-0004	AAV-07-M4.5x13	80-T20
<b>2020 K12</b>	●		20	20	125	10					
<b>2525 M12</b>	●		25	25	150	12.5					

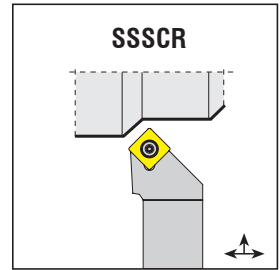
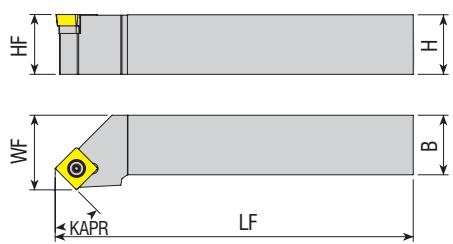
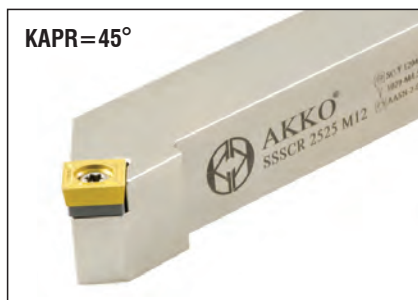

Takım Kodu Ordering Code Bestell-Bezeichnung	Stok Stock Lager		Takım Ölçüleri (mm) Dimension (mm) Abmessung (mm)				Kesici Uç Insert Wendeschneidplatte	Yedek Parçaları / Spare Parts / Ersatzteile			
	R	L	HF=H	B	LF	WF		Sıkma Vidası Screw Klemmschraube	Altlık Shim Unterlage	Altlık Vidası Shim Screw Schraube für Unterlage	Tork Anahtar Torx Key Torx-Schlüssel
<b>SSSCR/L 1212 F09</b>	●	●	12	12	80	16	<b>SC.T 09T3..</b>	4015-M3.5x11	-	-	80-T15
<b>1616 H09</b>	●	●	16	16	100	20		4015-M3.5x14	AASN-2-0001	AAV-06-M3.5x11	
<b>2020 K09</b>	●	●	20	20	125	25		4020-M4.5x12		AAV-10-M4.5x8	
<b>1616 H12</b>	●	●	16	16	100	20	<b>SC.T 1204..</b>	1020-M4.5x16	AASN-2-0004	AAV-07-M4.5x13	80-T20
<b>2020 K12</b>	●	●	20	20	125	25					
<b>2525 M12</b>	●	●	25	25	150	32					

R: Sağ / Right / Rechts L: Sol / Left / Links  
● Stokta / In Stock / Auf Lager ○ Stokta Yok / Non Stock Item / Kein Lagerartikel, Lieferzeit auf Anfrage

Sipariş Örneği/Ordering Example/Bestellbeispiel  
1 ad./pcs./stück SSDCN 1212 F09

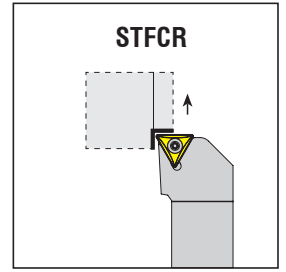
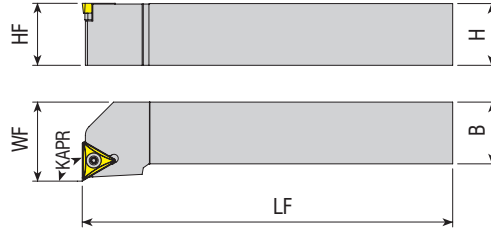

**Takım Kodu**  
**Ordering Code**  
*Bestell-Bezeichnung*

Stok Stock Lager	Takım Ölçüleri (mm) Dimension (mm) Abmessung (mm)						Kesici Uç Insert Wendeschneidplatte	Sıkma Vidası Screw Klemmschraube	Altlık Shim Unterlage	Altlık Vidası Shim Screw Schraube für Unterlage	Tork Anahtar Torx Key Torx-Schlüssel
	R	L	HF=H	B	LF	WF					
○	○	08	08	70	10	TC.T 0902..	3007-M2.2x4.6	-	-	82-T07	
●	●	10	10	70	12						
●	●	12	12	80	16	TC.T 1102..	4008-M2.5x6	-	-	82-T08	
●	●	16	16	100	20						
●	●	16	16	100	20	TC.T 16T3..	4015-M3.5x14	AATN-2-0001	AAV-06-M3.5x11	80-T15	
●	●	20	20	125	25						
●	●	25	25	150	32						
●	●	32	32	170	40						

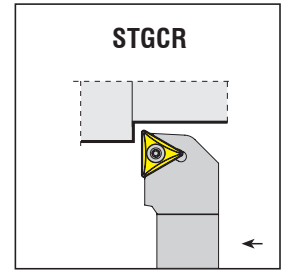
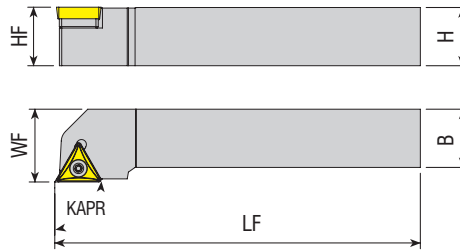

**Takım Kodu**  
**Ordering Code**  
*Bestell-Bezeichnung*

Stok Stock Lager	Takım Ölçüleri (mm) Dimension (mm) Abmessung (mm)						Kesici Uç Insert Wendeschneidplatte	Sıkma Vidası Screw Klemmschraube	Altlık Shim Unterlage	Altlık Vidası Shim Screw Schraube für Unterlage	Tork Anahtar Torx Key Torx-Schlüssel
	R	L	HF=H	B	LF	WF					
●	●	08	08	70	10	TC.T 0902..	3007-M2.2x4.6	-	-	82-T07	
●	●	10	10	70	12						
●	●	12	12	80	16	TC.T 1102..	4008-M2.5x6	-	-	82-T08	
●	●	16	16	100	20						
●	●	16	16	100	20	TC.T 16T3..	4015-M3.5x14	AATN-2-0001	AAV-06-M3.5x11	80-T15	
●	●	20	20	125	25						
●	●	25	25	150	32						
●	●	32	32	170	40						

R: Sağ / Right / Rechts L: Sol / Left / Links  
● Stokta / In Stock / Auf Lager ○ Stokta Yok / Non Stock Item / Kein Lagerartikel, Lieferzeit auf Anfrage

Sipariş Örneği/Ordering Example/Bestellbeispiel  
1 ad./pcs./stück STFGR 0808 E09



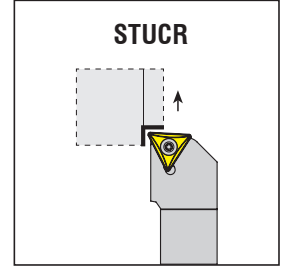
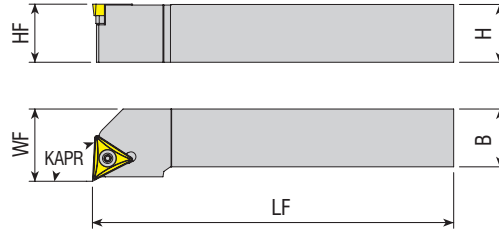

**Takım Kodu**  
**Ordering Code**  
*Bestell-Bezeichnung*

Stok Stock Lager	Takım Ölçüleri (mm) Dimension (mm) Abmessung (mm)					Kesici Uç Insert Wendeschneidplatte	Yedek Parçaları / Spare Parts / Ersatzteile				
	R	L	HF=H	B	LF		WF	Sıkma Vidası Screw Klemmschraube	Altlık Shim Unterlage	Altlık Vidası Shim Screw Schraube für Unterlage	Tork Anahtar Torx Key Torx-Schlüssel
							<b>TC.T 0902..</b>	3007-M2.2x4.6	-	-	82-T07
							<b>TC.T 1102..</b>	4008-M2.5x6	-	-	82-T08
							<b>TC.T 16T3..</b>	4015-M3.5x14	AATN-2-0001	AAV-06-M3.5x11	80-T15

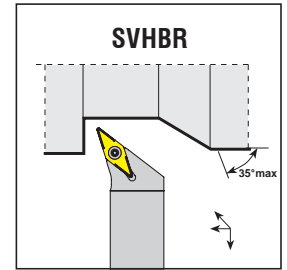
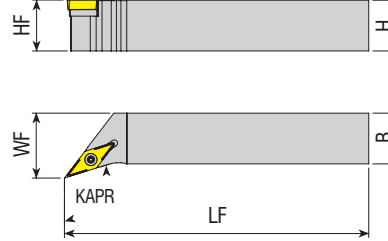
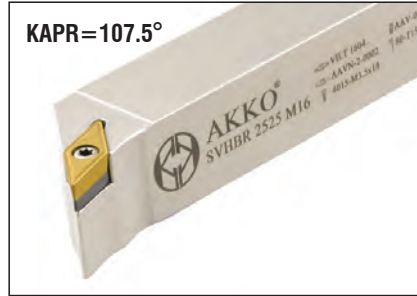

**Takım Kodu**  
**Ordering Code**  
*Bestell-Bezeichnung*

Stok Stock Lager	Takım Ölçüleri (mm) Dimension (mm) Abmessung (mm)					Kesici Uç Insert Wendeschneidplatte	Yedek Parçaları / Spare Parts / Ersatzteile				
	R	L	HF=H	B	LF		WF	Sıkma Vidası Screw Klemmschraube	Altlık Shim Unterlage	Altlık Vidası Shim Screw Schraube für Unterlage	Tork Anahtar Torx Key Torx-Schlüssel
							<b>VB.T 1103..</b>	4008-M2.5x6	-	-	82-T08
							<b>VB.T 1604..</b>	4015-M3.5x14	AAVN-2-0002	AAV-06-M3.5x11	80-T15

R: Sağ / Right / Rechts L: Sol / Left / Links  
● Stokta / In Stock / Auf Lager ○ Stokta Yok / Non Stock Item / Kein Lagerartikel, Lieferzeit auf Anfrage

Sipariş Örneği / Ordering Example / Bestellbeispiel  
1 ad./pcs./stück STUCR 0808 E09



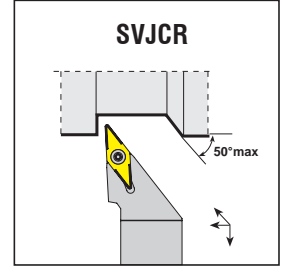
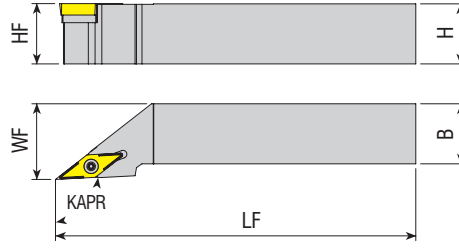

Takım Kodu Ordering Code Bestell-Bezeichnung	Stok Stock Lager		Takım Ölçüleri (mm) Dimension (mm) Abmessung (mm)				Kesici Uç Insert Wendeschneidplatte	Sıkma Vidası Screw Klemmschraube	Altlık Shim Unterlage	Altlık Vidası Shim Screw Schraube für Unterlage	Tork Anahtar Torx Key Torx-Schlüssel
	R	L	HF=H	B	LF	WF					
SVJCR/L 1212 F11	●	●	12	12	80	16	VC.T 1103..	4008-M2.5x6	-	-	82-T08
1616 H11	●	●	16	16	100	20					
2020 K11	●	●	20	20	125	25					
2525 M11	●	●	25	25	150	32					
1212 F16	●	●	12	12	80	16	VC.T 1604..	4015-M3.5x11	AAVN-2-0002	AAV-06-M3.5x11	80-T15
2020 K16	●	●	20	20	125	25					
2525 M16	●	●	25	25	150	32					
3232 P16	●	●	32	32	170	40					

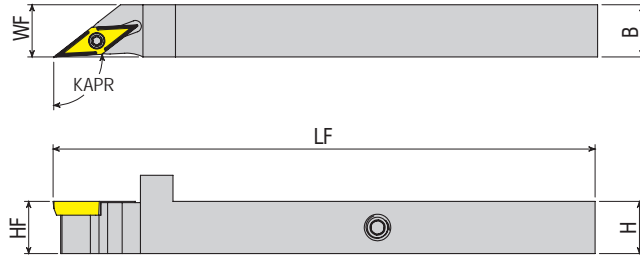
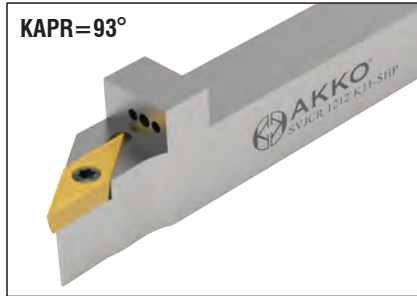

Takım Kodu Ordering Code Bestell-Bezeichnung	Stok Stock Lager		Takım Ölçüleri (mm) Dimension (mm) Abmessung (mm)				Kesici Uç Insert Wendeschneidplatte	Sıkma Vidası Screw Klemmschraube	Altlık Shim Unterlage	Altlık Vidası Shim Screw Schraube für Unterlage	Sızdırmaz Vida Threaded Pin Gewindestift	Anahtar Allen Key Innensechskantschlüssel	Tork Anahtar Torx Key Torx-Schlüssel
	R	L	HF=H	B	LF	WF							
SVJCR/L 1212 K11-SHP	●	○	12	12	125	12	VC.T 1103..	4008-M2.5x6	-	-	2703-M6X4	AAL-03-3	82-T08
1616 K11-SHP	●	○	16	16	125	16					2704-M8X1X5	AAL-05-4	

R: Sağ / Right / Rechts L: Sol / Left / Links

● Stokta / In Stock / Auf Lager ○ Stokta Yok / Non Stock Item / Kein Lagerartikel, Lieferzeit auf Anfrage  
ISO Ucuna Uygunudur. / Compatible with ISO Insert. / Kompatibel mit ISO Wendeplatten.

Sipariş Örneği/Ordering Example/Bestellbeispiel  
1 ad./pcs./stück SVJCR 1212 F11



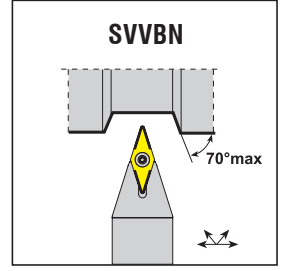
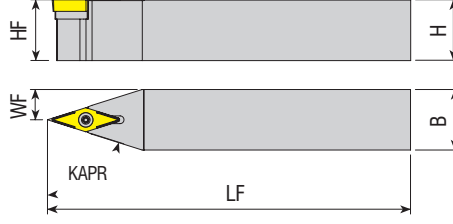

**Takım Kodu**  
**Ordering Code**  
*Bestell-Bezeichnung*

Stok Stock Lager	Takım Ölçüleri (mm) Dimension (mm) Abmessung (mm)				Kesici Uç Insert Wendeschneidplatte	Yedek Parçaları / Spare Parts / Ersatzteile				
	HF=H	B	LF	WF		Sıkma Vidası Screw Klemmschraube	Altlık Shim Unterlage	Altlık Vidası Shim Screw Schraube für Unterlage	Tork Anahtar Torx Key Torx-Schlüssel	
SVVBN 1212 F11	●	12	12	80	06	VB.T 1103..	4008-M2.5x6	-	-	82-T08
1616 H11	●	16	16	100	08					
2020 K11	●	20	20	125	10					
2020 K16	●	20	20	125	10	VB.T 1604..	4015-M3.5x14	AAVN-2-0002	AAV-06-M3.5x11	80-T15
2525 M16	●	25	25	150	12.5					
3232 P16	●	32	32	170	16					

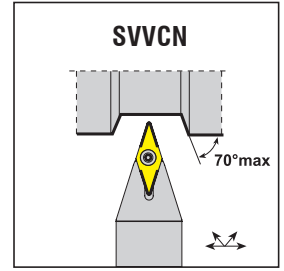
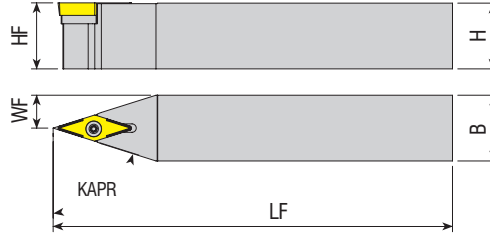

**Takım Kodu**  
**Ordering Code**  
*Bestell-Bezeichnung*

Stok Stock Lager	Takım Ölçüleri (mm) Dimension (mm) Abmessung (mm)				Kesici Uç Insert Wendeschneidplatte	Yedek Parçaları / Spare Parts / Ersatzteile				
	HF=H	B	LF	WF		Sıkma Vidası Screw Klemmschraube	Altlık Shim Unterlage	Altlık Vidası Shim Screw Schraube für Unterlage	Tork Anahtar Torx Key Torx-Schlüssel	
SVVCN 1212 F11	●	12	12	80	06	VC.T 1103..	4008-M2.5x6	-	-	82-T08
1616 H11	●	16	16	100	08					
2020 K11	●	20	20	125	10					
2020 K16	●	20	20	125	10	VC.T 1604..	4015-M3.5x14	AAVN-2-0002	AAV-06-M3.5x11	80-T15
2525 M16	●	25	25	150	12.5					
3232 P16	●	32	32	170	16					

R: Sağ / Right / Rechts L: Sol / Left / Links

● Stokta / In Stock / Auf Lager ○ Stokta Yok / Non Stock Item / Kein Lagerartikel, Lieferzeit auf Anfrage

Sipariş Örneği/Ordering Example/Bestellbeispiel

1 ad./pcs./stück SVVBN 1212 F11

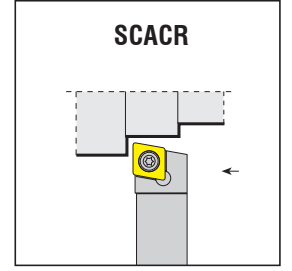
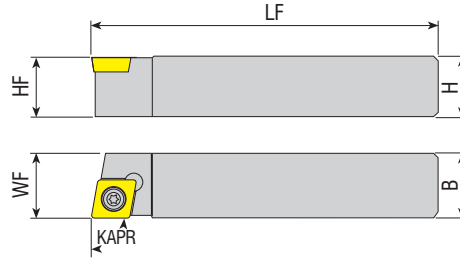
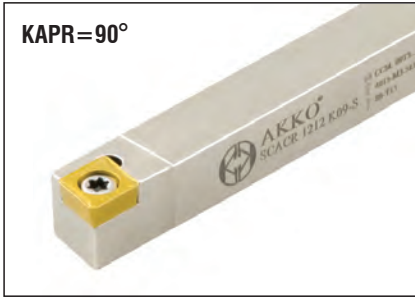

**Takım Kodu**  
**Ordering Code**  
**Bestell-Bezeichnung**

Stok  
Stock  
Lager

Takım Ölçüleri (mm)  
Dimension (mm)  
Abmessung (mm)

Kesici Uç  
Insert  
Wendeschneidplatte

Yedek Parçaları / Spare Parts / Ersatzteile

Sıkma Vidası  
Screw  
Klemmschraube

Altlık  
Shim  
Unterlage

Altlık Vidası  
Shim Screw  
Schraube für Unterlage

Tork Anahtar  
Torx Key  
Torx-Schlüssel

R L HF=H B LF WF



Takım Kodu Ordering Code Bestell-Bezeichnung	R	L	HF=H	B	LF	WF
SCACR/L 0808 X06-S	●	●	08	08	115	08
1010 K06-S	●	○	10	10	125	10
1212 G06-S	●	○	12	12	90	12
1212 K06-S	●	○	12	12	125	12
1616 F06-S	○	○	16	16	75	16
1616 K06-S	○	○	16	16	125	16
1212 G09-S	○	○	12	12	90	12
1212 K09-S	●	●	12	12	125	12
1616 F09-S	○	○	16	16	75	16
1616 K09-S	●	●	16	16	125	16
2020 K09-S	●	●	20	20	125	20

CC.T 0602..

4008-M2.5x6

-

-

82-T08

CC.T 09T3..

4015-M3.5x11

-

-

80-T15

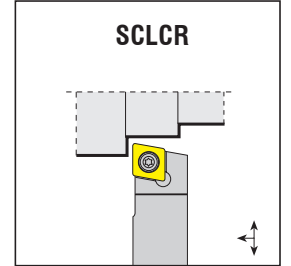
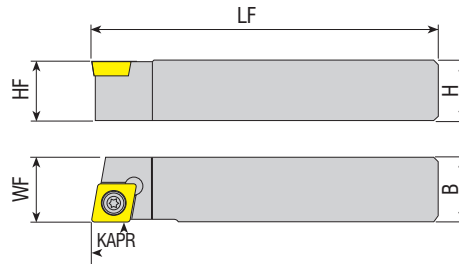
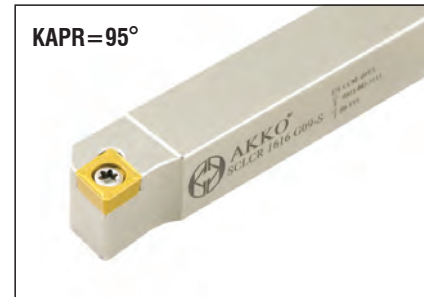

**Takım Kodu**  
**Ordering Code**  
**Bestell-Bezeichnung**

Stok  
Stock  
Lager

Takım Ölçüleri (mm)  
Dimension (mm)  
Abmessung (mm)

Kesici Uç  
Insert  
Wendeschneidplatte

Yedek Parçaları / Spare Parts / Ersatzteile

Sıkma Vidası  
Screw  
Klemmschraube

Altlık  
Shim  
Unterlage

Altlık Vidası  
Shim Screw  
Schraube für Unterlage

Tork Anahtar  
Torx Key  
Torx-Schlüssel

R L HF=H B LF WF

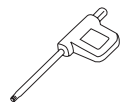

Takım Kodu Ordering Code Bestell-Bezeichnung	R	L	HF=H	B	LF	WF
SCLCR/L 0808 X06-S	●	●	08	08	115	08
1010 X06-S	●	○	10	10	115	10
1212 G06-S	●	○	12	12	90	12
1212 X06-S	●	○	12	12	130	12
1212 K06-S	○	○	12	12	125	12
1616 F06-S	○	○	16	16	75	16
1616 X06-S	●	○	16	16	130	16
1212 G09-S	○	○	12	12	90	12
1212 X09-S	○	○	12	12	130	12
1616 F09-S	○	○	16	16	75	16
1616 G09-S	○	○	16	16	90	16
1616 X09-S	○	○	16	16	115	16
2020 X09-S	○	○	20	20	120	20

CC.T 0602..

4008-M2.5x6

-

-

82-T08

CC.T 09T3..

4015-M3.5x11

-

-

80-T15

R: Sağ / Right / Rechts L: Sol / Left / Links

● Stokta / In Stock / Auf Lager ○ Stokta Yok / Non Stock Item / Kein Lagerartikel, Lieferzeit auf Anfrage

Sipariş Örneği/Ordering Example/Bestellbeispiel

1 ad./pcs./stück SCACR 0808 X06-S



www.akko.com.tr

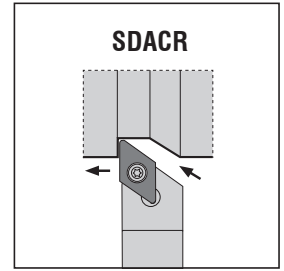
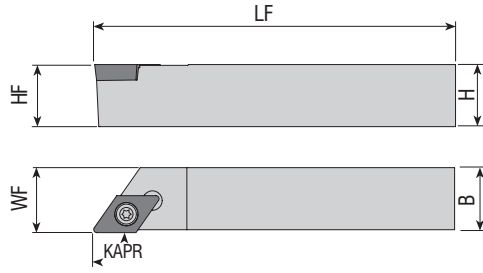

Yedek Parçaları / Spare Parts / Ersatzteile

Takım Kodu  
Ordering Code  
Bestell-Bezeichnung

Stok Stock Lager	Takım Ölçüleri (mm) Dimension (mm) Abmessung (mm)						Kesici Uç Insert Wendeschneidplatte	Sıkma Vidası Screw Klemmschraube	Altlık Shim Unterlage	Altlık Vidası Shim Screw Schraube für Unterlage	Tork Anahtar Torx Key Torx-Schlüssel					
	R	L	HF=H	B	LF	WF										
SDACR/L 0808 X07-S	●	●	08	08	115	08	DC.T 0702..	4008-M2.5x6	-	-	82-T08					
1010 K07-S	●	●	10	10	125	10										
1212 G07-S	○	○	12	12	90	12										
1212 K07-S	●	●	12	12	125	12										
1616 F07-S	●	○	16	16	75	16										
1616 K07-S	●	●	16	16	125	16										
1212 G11-S	○	○	12	12	90	12						DC.T 11T3..	4015-M3.5x11	-	-	80-T15
1212 K11-S	●	●	12	12	125	12										
1616 F11-S	●	○	16	16	75	16										
1616 K11-S	●	●	16	16	125	16										
2020 K11-S	●	○	20	20	125	20										

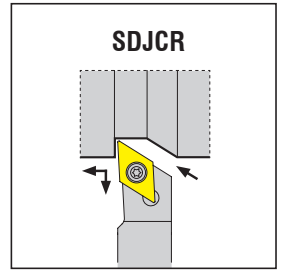
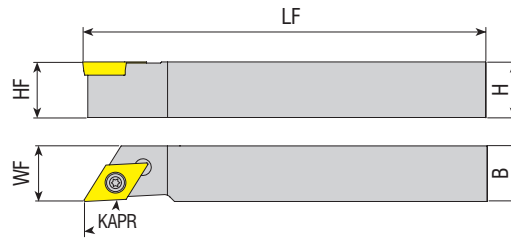
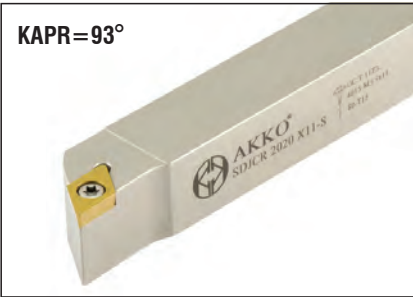

Yedek Parçaları / Spare Parts / Ersatzteile

Takım Kodu  
Ordering Code  
Bestell-Bezeichnung

Stok Stock Lager	Takım Ölçüleri (mm) Dimension (mm) Abmessung (mm)						Kesici Uç Insert Wendeschneidplatte	Sıkma Vidası Screw Klemmschraube	Altlık Shim Unterlage	Altlık Vidası Shim Screw Schraube für Unterlage	Tork Anahtar Torx Key Torx-Schlüssel					
	R	L	HF=H	B	LF	WF										
SDJCR/L 0808 X07-S	●	○	08	08	115	08	DC.T 0702..	4008-M2.5x6	-	-	82-T08					
1010 X07-S	●	●	10	10	115	10										
1212 G07-S	●	○	12	12	90	12										
1212 X07-S	●	●	12	12	130	12										
1616 F07-S	●	○	16	16	75	16										
1616 X07-S	●	○	16	16	130	16										
2020 X07-S	●	○	20	20	120	20						DC.T 11T3..	4015-M3.5x11	-	-	80-T15
1212 G11-S	●	○	12	12	90	12										
1212 X11-S	●	●	12	12	130	12										
1212 K11-S	●	●	12	12	125	12										
1616 F11-S	●	○	16	16	75	16										
1616 X11-S	●	○	16	16	130	16										
1616 K11-S	●	○	16	16	125	16										
2020 X11-S	●	○	20	20	120	20										

R: Sağ / Right / Rechts L: Sol / Left / Links

● Stokta / In Stock / Auf Lager ○ Stokta Yok / Non Stock Item / Kein Lagerartikel, Lieferzeit auf Anfrage

Sipariş Örneği/Ordering Example/Bestellbeispiel

1 ad./pcs./stück SDACR 0808 X07-S

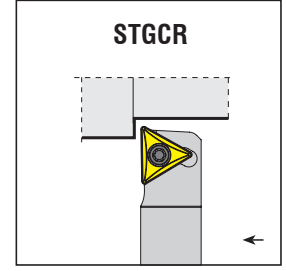
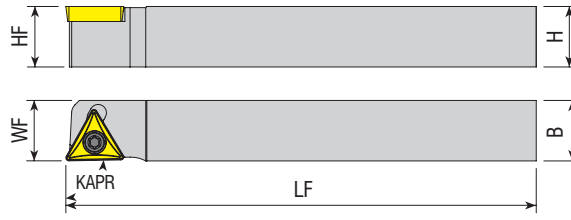

Takım Kodu Ordering Code Bestell-Bezeichnung	Stok Stock Lager		Takım Ölçüleri (mm) Dimension (mm) Abmessung (mm)				Kesici Uç Insert Wendeschneidplatte	Yedek Parçaları / Spare Parts / Ersatzteile				
	R	L	HF=H	B	LF	WF		Sıkma Vidası Screw Klemmschraube	Altlık Shim Unterlage	Altlık Vidası Shim Screw Schraube für Unterlage	Tork Anahtar Torx Key Torx-Schlüssel	
	●	○										
STGCR/L 1216 K11-S	●	○	12	16	125	16	TC.T 1102..	4008-M2.5x6	-	-	82-T08	
1616 K11-S	●	○	16	16	125	16						
1216 K16-S	●	○	12	16	125	16	TC.T 16T3..	4015-M3.5x11	-	-	80-T15	
1616 K16-S	●	○	16	16	125	16						

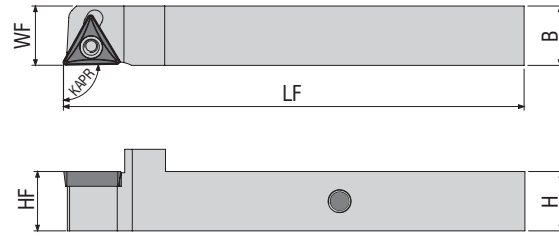
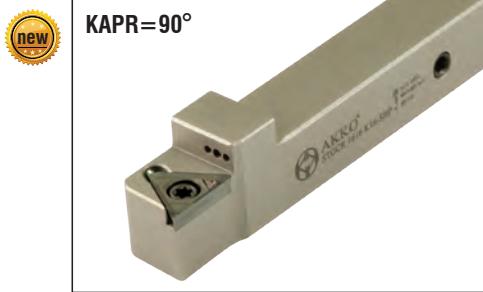

Takım Kodu Ordering Code Bestell-Bezeichnung	Stok Stock Lager		Takım Ölçüleri (mm) Dimension (mm) Abmessung (mm)				Kesici Uç Insert Wendeschneidplatte	Yedek Parçaları / Spare Parts / Ersatzteile					
	R	L	HF=H	B	LF	WF		Sıkma Vidası Screw Klemmschraube	Altlık Shim Unterlage	Altlık Vidası Shim Screw Schraube für Unterlage	Sızdırmaz Vida Threaded Pin Gewindestift	Anahtar Allen Key Insechschlüssel	Tork Anahtar Torx Key Torx-Schlüssel
	●	○											
STGCR/L 1216 K16-SHP	●	○	12	16	125	16	TC.T 16T3..	4015-M3.5x14	AATN-2-0001	AAV-06-M3.5x11	2703-M6X4	AAL-03-3	80-T15
1616 K16-SHP	●	○	16	16	125	16					2704-M8X1X5	AAL-05-4	

R: Sağ / Right / Rechts L: Sol / Left / Links  
● Stokta / In Stock / Auf Lager ○ Stokta Yok / Non Stock Item / Kein Lagerartikel, Lieferzeit auf Anfrage  
ISO Ucuna Uygundur. / Compatible with ISO Insert. / Kompatibel mit ISO Wendepfatten.

Sipariş Örneği/Ordering Example/Bestellbeispiel  
1 ad./pcs./stück STGCR 1216 K11-S

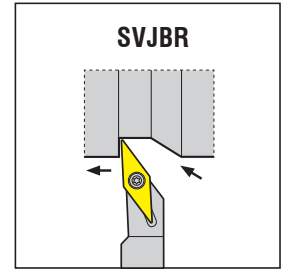
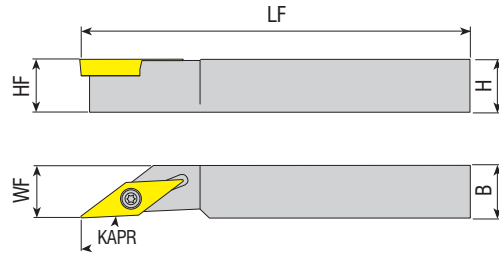

**Takım Kodu**  
**Ordering Code**  
*Bestell-Bezeichnung*

Stok Stock Lager	Takım Ölçüleri (mm) Dimension (mm) Abmessung (mm)						Kesici Uç Insert Wendeschneidplatte	Yedek Parçaları / Spare Parts / Ersatzteile			
	R	L	HF=H	B	LF	WF		Sıkma Vidası Screw Klemmschraube	Altlık Shim Unterlage	Altlık Vidası Shim Screw Schraube für Unterlage	Tork Anahtar Torx Key Torx-Schlüssel
							<b>VB.T 1103..</b>	4008-M2.5x6	-	-	82-T08

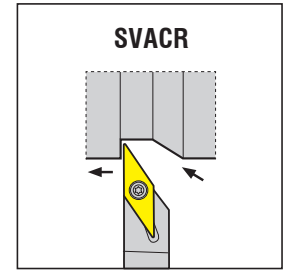
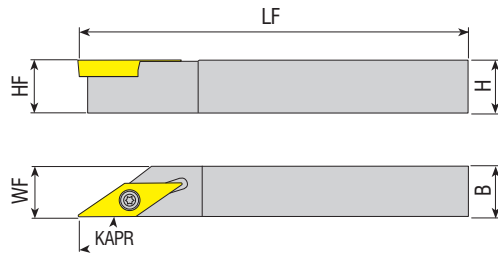

**Takım Kodu**  
**Ordering Code**  
*Bestell-Bezeichnung*

Stok Stock Lager	Takım Ölçüleri (mm) Dimension (mm) Abmessung (mm)						Kesici Uç Insert Wendeschneidplatte	Yedek Parçaları / Spare Parts / Ersatzteile			
	R	L	HF=H	B	LF	WF		Sıkma Vidası Screw Klemmschraube	Altlık Shim Unterlage	Altlık Vidası Shim Screw Schraube für Unterlage	Tork Anahtar Torx Key Torx-Schlüssel
							<b>VC.T 1103..</b>	4008-M2.5x6	-	-	82-T08
							<b>VC.T 1604..</b>	4015-M3.5x11			80-T15

R: Sağ / Right / Rechts L: Sol / Left / Links

● Stokta / In Stock / Auf Lager ○ Stokta Yok / Non Stock Item / Kein Lagerartikel, Lieferzeit auf Anfrage

Sipariş Örneği/Ordering Example/Bestellbeispiel

1 ad./pcs./stück SVJBR 1616 K11-S

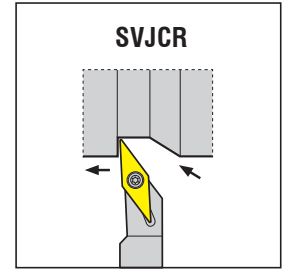
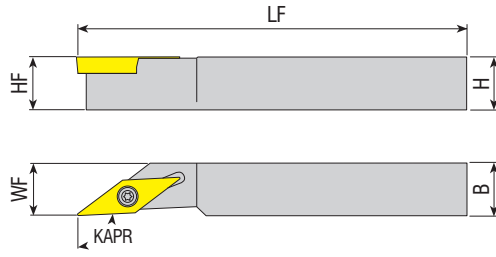

Takım Kodu Ordering Code Bestell-Bezeichnung	Stok Stock Lager		Takım Ölçüleri (mm) Dimension (mm) Abmessung (mm)				Kesici Uç Insert Wendeschneidplatte	Yedek Parçaları / Spare Parts / Ersatzteile			
	R	L	HF=H	B	LF	WF		Sıkma Vidası Screw Klemmschraube	Altık Shim Unterlage	Altık Vidası Shim Screw Schraube für Unterlage	Tork Anahtar Torx Key Torx-Schlüssel
SVJCR/L 0808 X11-S	●	○	08	08	115	08	VC.T 1103..	4008-M2.5x6	-	-	82-T08
1010 K11-S	●	○	10	10	125	10					
1212 G11-S	○	○	12	12	90	12					
1212 K11-S	●	○	12	12	125	12					
1616 F11-S	○	○	16	16	75	16					
1616 K11-S	●	○	16	16	125	16					
2020 K11-S	○	○	20	20	125	20					

> SEC TOOLS

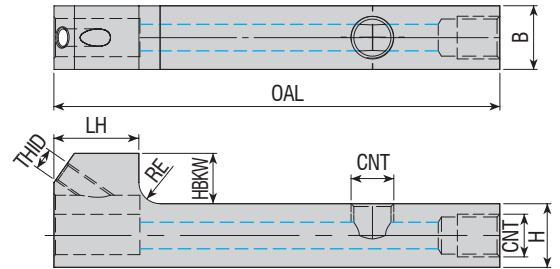

Takım Kodu Ordering Code Bestell-Bezeichnung	Stok Stock Lager	Takım Ölçüleri (mm) Dimension (mm) Abmessung (mm)								Yedek Parçaları / Spare Parts / Ersatzteile		
		H	B	RE	HBKW	LH	OAL	CNT	THID	Sızdırmaz Vida Threaded Pin Резьбовой Винт	Montaj Vidası Mounting Screw Монтажный Винт	Anahtar Allen Key Innensechskantschlüssel
ASTB-1212-L84-H	●	12	12	4	9.5	16	84	M8X1X5	M4x0.7	2704-M8X1X5	2503-M4x12-C	AAL-03-3
ASTB-1616-L90-H	●	16	16	1	5.5	16	90	M8X1X5	M4x0.7			

R: Sağ / Right / Rechts L: Sol / Left / Links

● Stokta / In Stock / Auf Lager ○ Stokta Yok / Non Stock Item / Kein Lagerartikel, Lieferzeit auf Anfrage

Sipariş Örneği/Ordering Example/Bestellbeispiel

1 ad./pcs./stück SVJCR 0808 X11-S

KAPR=93°

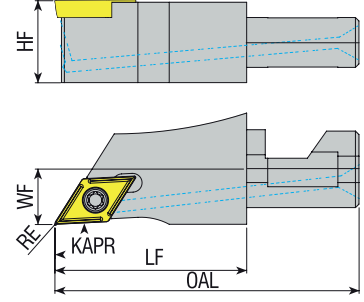

Takım Kodu Ordering Code Bestell-Bezeichnung	Stok Stock Lager		Takım Ölçüleri (mm) Dimension (mm) Abmessung (mm)					Kesici Uç Insert Wendeschneidplatte	Yedek Parçaları / Spare Parts / Ersatzteile		
	R	L	HF	WF	RE	LF	OAL		Sıkma Vidası Screw Klemmschraube	Tork Anahtar Torx Key Torx-Schlüssel	
SDJCR/L-12X43.3-07	●	●	11.8	8	0.2	27.3	43.3	DC.T 070202	4008-M2.5x6	82-T08	
12X43.3-07-H	●	●	11.8	8	0.2	27.3	43.3				
16X43.3-07	●	●	15.8	8	0.2	27.3	43.3				
16X43.3-07-H	●	●	15.8	8	0.2	27.3	43.3				
12X43.3-11	●	●	11.8	8	0.2	27.3	43.3	DC.T 11T302	4015-M3.5x9	80-T15	
12X43.3-11-H	●	●	11.8	8	0.2	27.3	43.3				
16X43.3-11	●	●	15.8	8	0.2	27.3	43.3				
16X43.3-11-H	●	●	15.8	8	0.2	27.3	43.3				

KAPR=93°

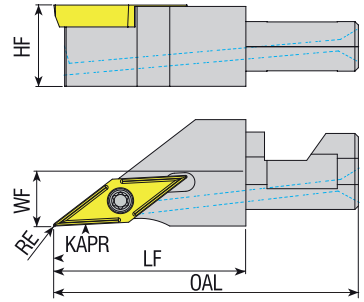

Takım Kodu Ordering Code Bestell-Bezeichnung	Stok Stock Lager		Takım Ölçüleri (mm) Dimension (mm) Abmessung (mm)					Kesici Uç Insert Wendeschneidplatte	Yedek Parçaları / Spare Parts / Ersatzteile		
	R	L	HF	WF	RE	LF	OAL		Sıkma Vidası Screw Klemmschraube	Tork Anahtar Torx Key Torx-Schlüssel	
SVJCR/L-12X43.3-11	●	●	11.8	8	0.2	27.3	43.3	VC.T 110302	4008-M2.5x6	82-T08	
12X43.3-11-H	●	●	11.8	8	0.2	27.3	43.3				
16X43.3-11	●	●	15.8	8	0.2	27.3	43.3				
16X43.3-11-H	●	●	15.8	8	0.2	27.3	43.3				

R: Sağ / Right / Rechts L: Sol / Left / Links

● Stokta / In Stock / Auf Lager ○ Stokta Yok / Non Stock Item / Kein Lagerartikel, Lieferzeit auf Anfrage

Sipariş Örneği/Ordering Example/Bestellbeispiel

1 ad./pcs./stück SDJCR-12X43.3-07

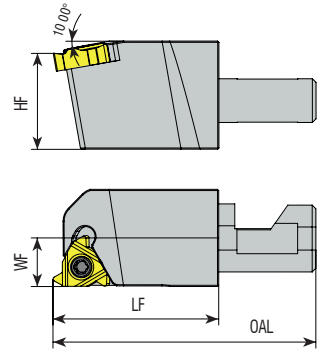
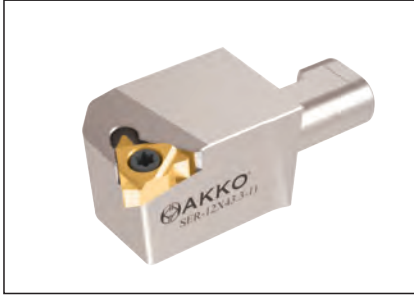

Takım Kodu Ordering Code Bestell-Bezeichnung	Stok Stock Lager		Takım Ölçüleri (mm) Dimension (mm) Abmessung (mm)				Kesici Uç Insert Wendeschneidplatte	Sıkma Vidası Screw Klemmschraube	Yedek Parçaları / Spare Parts / Ersatzteile				
	R	L	OAL	LF	WF	HF			Sağ Altlık Right Shim U-Platte für WSP rechts	Sol Altlık Left Shim U-Platte für WSP links	Altık Vidası Shim Screw Schraube für Unterlage	Altık Vidası Pulu Shim Screw Ring Schraube für Unterlagering	Tork Anahtar Torx Key
SER/L-12x43.3-11	●	●	43.3	27.3	8	11.8			-	-	-	-	
SER/L-16x43.3-11	●	●	43.3	27.3	8	15.8	11 ER/EL	4008-M2.5x6	-	-	-	-	82-T08
TER/L-16x43.3-16	●	●	43.3	27.3	8	15.8	16 ER/EL	1710-U5-40x12.2	ATS-16E	ATS-16I	AAV-11-U5-40x4.5	ABPL-03	82-T10

R: Sağ / Right / Rechts L: Sol / Left / Links

● Stokta / In Stock / Auf Lager ○ Stokta Yok / Non Stock Item / Kein Lagerartikel, Lieferzeit auf Anfrage

Sipariş Örneği/Ordering Example/Bestellbeispiel

1 ad./pcs./stück SER/L-12x43.3-11

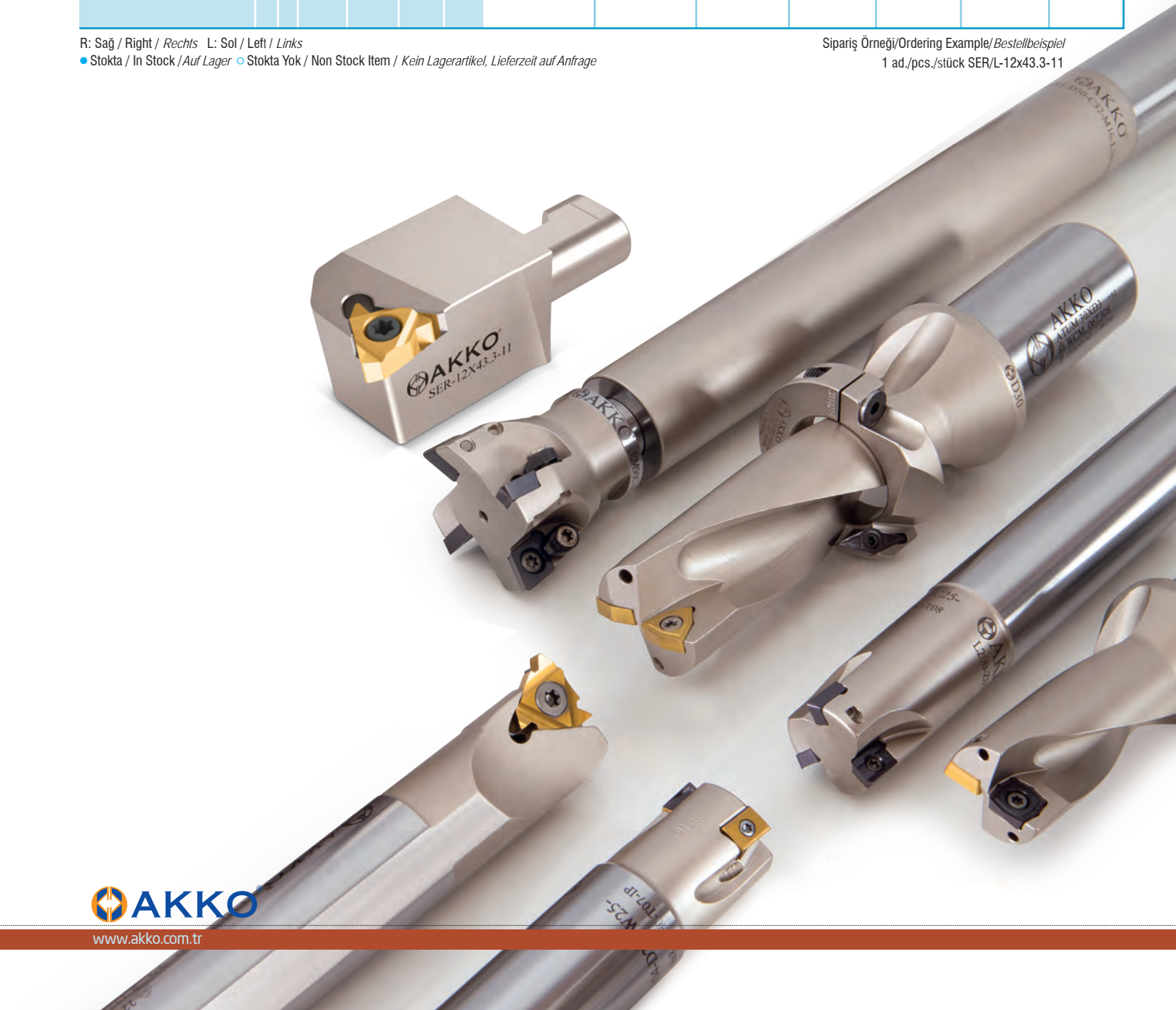



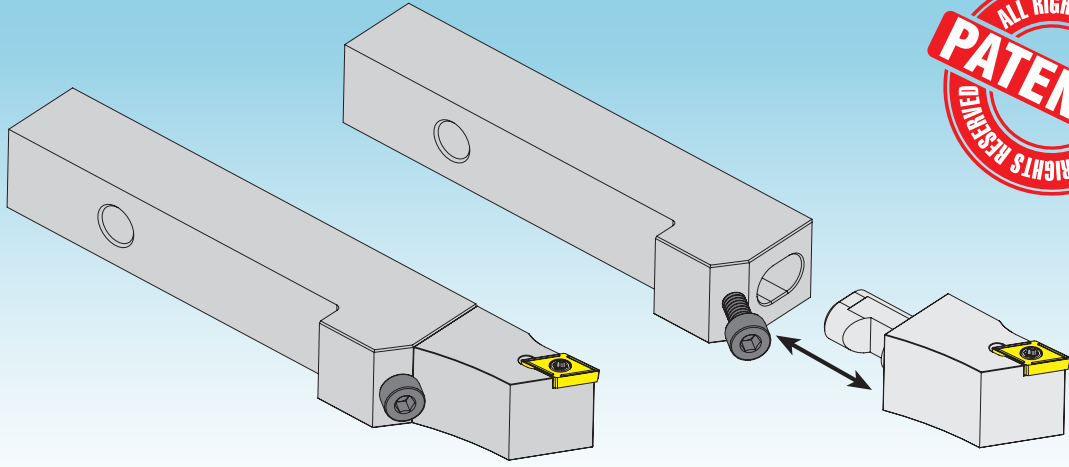

Takım tutucuyu, bağlama ünitesinden sökme zorunluğunu kalmadan hızlıca değiştirin!

Quick change, without having to remove the tool-holder from the gang !

Es ist nicht nötig, den Grundhalter vom Werkzeugträger zu entfernen schnelle wechsel möglich!

Makina dışında ön ayar yapmak mümkün.

Presetting is possible outside of the machine.

Voreinstellung ausserhalb der Maschine ist möglich.

Çok hassas montaj.

Ultra precise fitting.

Ultra-präziser Montage.

Rijit sabitleme.

Rigid fixation.

Starre Befestigung.

Takım tutucu bölümü: 12x12 ve 16x16 mm.

Tool-holder section : 12x12 and 16x16 mm.

Grundhalter: 12x12 und 16x16mm.

Sağ ve sol uçlar kullanılır.

Left and right inserts available.

Links und Rechts WSP verwendbar.

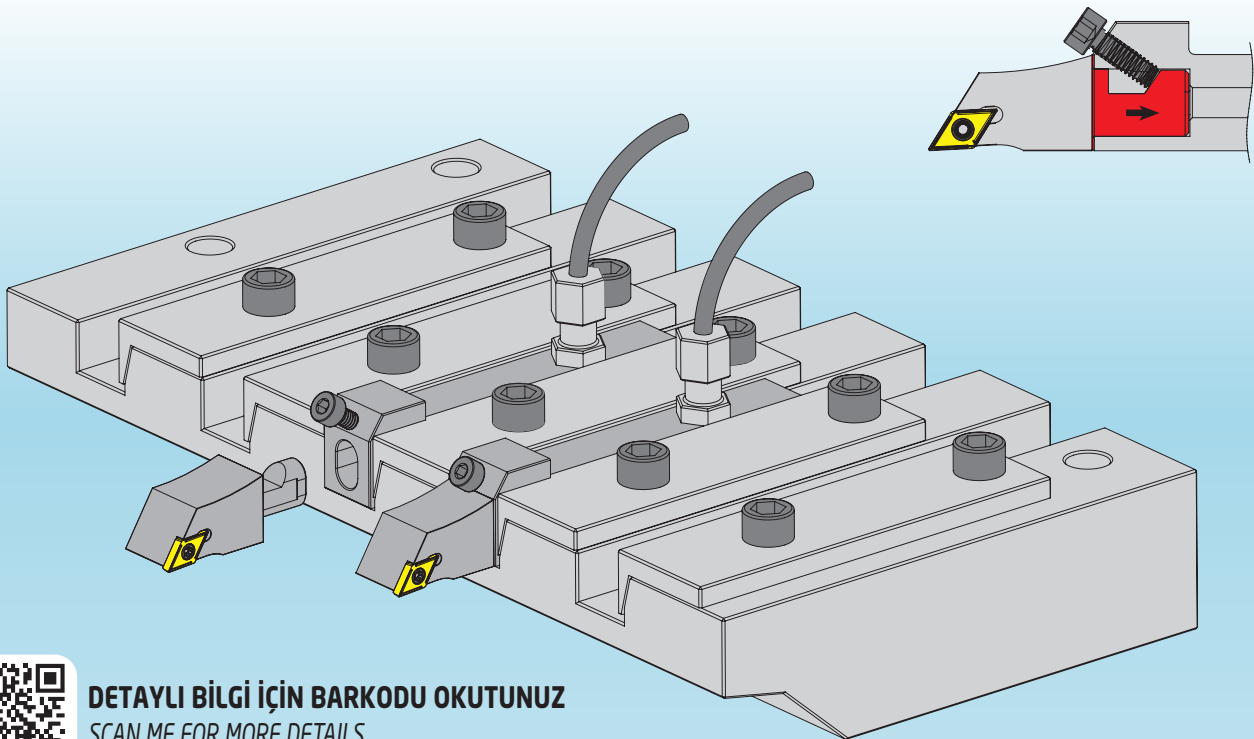

**DETAYLI BİLGİ İÇİN BARKODU OKUTUNUZ**

SCAN ME FOR MORE DETAILS

SCANNEN SIE MICH NACH WEITEREN DETAILS



**DELİK TORNA TAKIMLARI**  
**INTERNAL TURNING TOOLHOLDERS**  
*DREHWERKZEUGE FÜR DIE INNENBEARBEITUNG*





**S**

1

**25**

2

**S**

3

**P**

4

**C**

5

**L**

6

**N**

7

**R**

8

**12**

9

**C**

10

**1** Takım Malzemesi / Type of Boring Bar / Art der Bohrstange

"A" Yekpare çelik gövde soğutma suyu kanallı / "A" Solid steel with coolant hole  
"A" Vollstahlausführung mit innerer Kühlmittelzufuhr  
"E" Carbide bar with fixed steel head and coolant hole  
"E" Hartmetallschaft mit Kopf aus Stahl und innerer Kühlmittelzufuhr  
"C" Karbür Şaft / "C" Carbide shank / "C" Hartmetallschaft mit Kopf aus Stahl ohne innerer Kühlmittelzufuhr  
"S" Çelik Şaft / "S" Steel shank / "S" Vollstahlausführung ohne innerer Kühlmittelzufuhr

**2** Şaft Çapı / Shank Diameter / Schaft Durchmesser

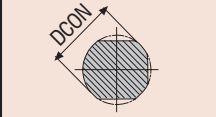

**3** Şaft Boyu / Shank Length / Schaft Länge

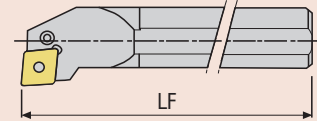

			(mm)
A - 32	H - 100	Q - 180	x-special
B - 40	J - 110	R - 200	
C - 50	K - 125	S - 250	
D - 60	L - 140	T - 300	
E - 70	M - 150	U - 350	
F - 80	N - 160	V - 400	
G - 90	P - 170	W - 450	

**4** Sıkma Tipi / Method of Mounting of Insert / Art der Schneideplattenbefestigung

<b>C</b>	<b>T</b>	<b>M</b>	<b>P</b>	<b>S</b>

**5** Uç Tipi / Type of Insert / Plattenform

<b>C</b>	<b>D</b>	<b>E</b>
<b>V</b>	<b>R</b>	<b>S</b>
<b>W</b>	<b>K</b>	<b>T</b>

**6** Yanaşma Açısı / Tool Holder Shape Bar Geometry / Anstellwinkel

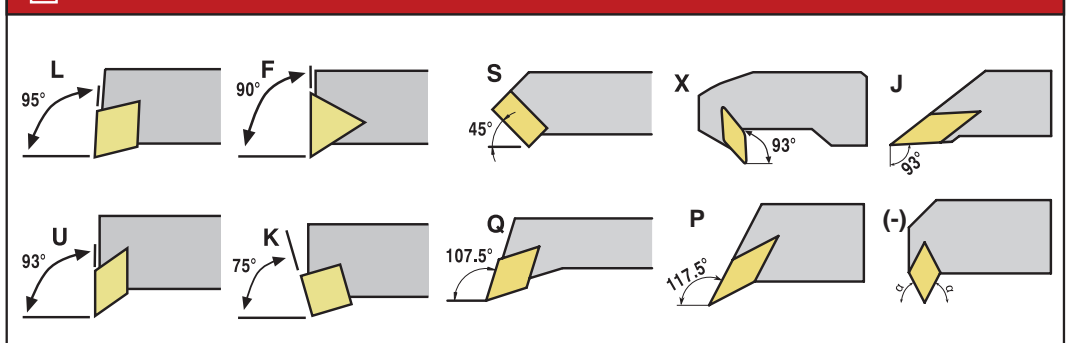

**7** Serbest Uç Açısı / Insert Clearance Angle / Freiwinkel

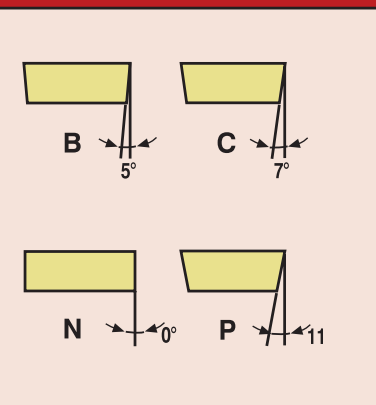

**8** Kesme Yönü / Cutting Direction / Halteraussührung

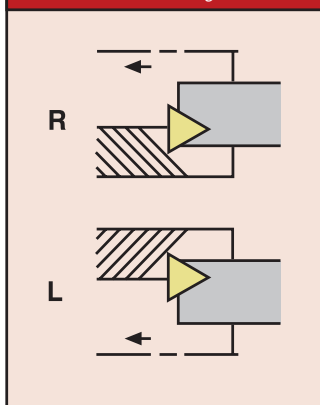

**9** Kesme Kenar Uzunluğu / Cutting Edge Length / Schneidkantenlänge

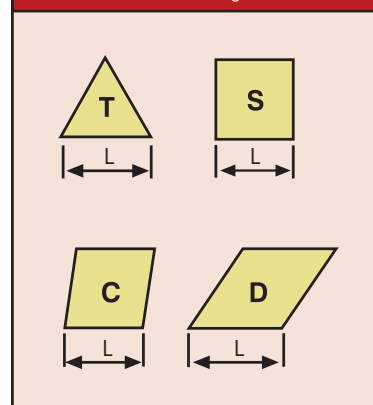

**10** Baskı Pabucu / Wedge Clamp / Spannpratze

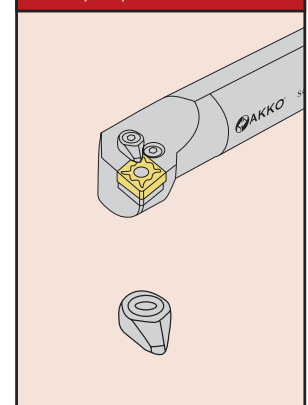



*konusulan  
the spoken kalite...  
quality...*

# T&C-SİSTEM

**T&C SİSTEM DELİK TORNA KATERLERİ**  
T&C SYSTEM BORING BARS  
T&C SYSTEM BOHRSTANGE



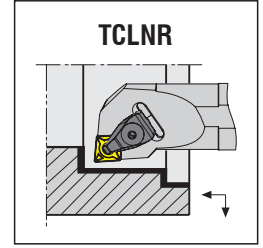
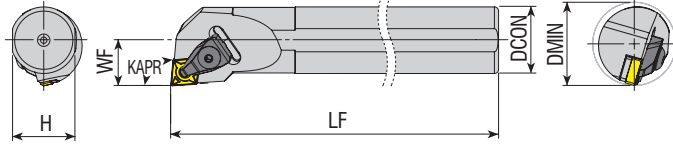

**Takım Kodu**  
**Ordering Code**  
**Bestell-Bezeichnung**

Stok Stock Lager	Takım Ölçüleri (mm) Dimension (mm) Abmessung (mm)						Kesici Uç Insert Wendeschneidplatte	Baskı Pabuçu Wedge Clamp Spannpratze	Pabuç Vidası Clamp Screw Klemmschraube	Yedek Parçaları / Spare Parts / Ersatzteile		Segman Ring Feder	Pul Stamp Ring	Anahtar Allen Key Innerschloßschlüssel	
	R	L	DCON	H	LF	WF				DMIN	Altılık Shim Unterlage				Altılık Vidası Shim Screw Schraube für Unterlage
	●	●	25	23	250	17	≥32	CNM. 0903..	ATK-01	AKV-01-M5x22	AACN-2-0001	AAV-09-M5x9	-		
	●	●	25	23	250	17	≥32					AAV-13-M5x8			
	●	●	32	30	300	22	≥40	CNM. 1204..	ATK-02	AKV-30-M6x22	AACN-3-0001	AAV-02-M5x12	AS-01	ABPL-01	AAL-03-3
	●	●	40	37.5	350	27	≥50								
	●	●	50	47	400	35	≥63								
	●	●	32	30	300	22	≥40								
	●	●	40	37.5	350	27	≥50	CNM. 1606..	ATK-04	AKV-19-M7x25	AACN-3-0002	AAV-05-M6x15	AS-02	ABPL-02	AAL-05-4
	●	●	50	47	400	35	≥63								
new	●	○	25	23	200	17	≥32					AAV-13-M5x8			
new	●	○	40	37.5	300	27	≥50	CNM. 1204..	ATK-02	AKV-30-M6x22	AACN-3-0001	AAV-02-M5x12	AS-01	ABPL-01	AAL-03-3
new	○	●	50	47	400	35	≥63								

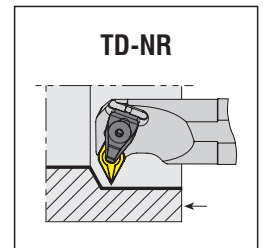
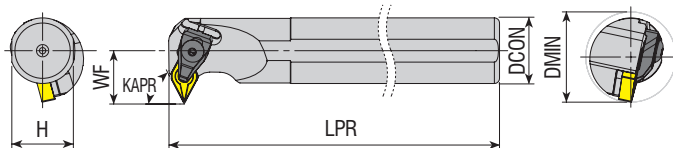

**Takım Kodu**  
**Ordering Code**  
**Bestell-Bezeichnung**

Stok Stock Lager	Takım Ölçüleri (mm) Dimension (mm) Abmessung (mm)						Kesici Uç Insert Wendeschneidplatte	Baskı Pabuçu Wedge Clamp Spannpratze	Pabuç Vidası Clamp Screw Klemmschraube	Yedek Parçaları / Spare Parts / Ersatzteile		Segman Ring Feder	Pul Stamp Ring	Anahtar Allen Key Innerschloßschlüssel	
	R	L	DCON	H	LPR	WF				DMIN	Altılık Shim Unterlage				Altılık Vidası Shim Screw Schraube für Unterlage
	●	●	32	30	300	26	≥44								
	●	●	40	37.5	350	29	≥52	DNM. 1506..	ATK-02	AKV-30-M6x22	AADN-3-0001	AAV-02-M5x12	AS-01	ABPL-01	AAL-03-3
	●	●	50	47	400	35	≥63								

R: Sağ / Right / Rechts L: Sol / Left / Links

● Stokta / In Stock / Auf Lager ○ Stokta Yok / Non Stock Item / Kein Lagerartikel, Lieferzeit auf Anfrage

Sipariş Örneği/Ordering Example/Bestellbeispiel

1 ad./pcs./stück S25S TCLNR 09

# T-SİSTEM DELİK TORNA KATERLERİ

T-SYSTEM BORING BARS  
T-SYSTEM BOHRSTANGE

KAPR=107.5°

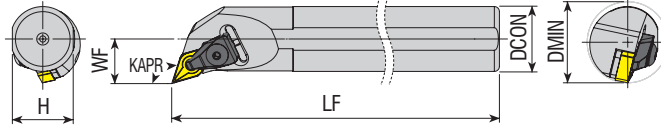

TDQNR

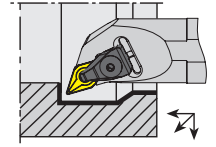

**Takım Kodu**  
**Ordering Code**  
**Bestell-Bezeichnung**

Stok Stock Lager	Takım Ölçüleri (mm) Dimension (mm) Abmessung (mm)						Kesici Uç Insert Wendeschneidplatte	Baskı Pabucu Wedge Clamp Spannpratze	Pabuç Vidası Clamp Screw Klemmschraube	Yedek Parçaları / Spare Parts / Ersatzteile					
	R	L	DCON	H	LF	WF				DMIN	Altlık Shim Unterlage	Altlık Vidası Shim Screw Schraube für Unterlage	Segman Ring Feder	Pul Stamp Ring	Anahtar Allen Key Innensechskantschlüssel
	●	●	25	23	250	17	≥32	DNM. 1104..	ATK-01	AKV-01-M5x22	AADN-2-0001	AAV-09-M5x9	-	ABPL-01	AAL-03-3
	●	●	32	30	300	22	≥40					AAV-04-M5x12			
	●	●	25	23	250	17	≥32	DNM. 1506..	ATK-02	AKV-30-M6x22	AADN-3-0001	AAV-13-M5x8	AS-01	ABPL-01	AAL-03-3
	●	●	32	30	300	22	≥40					AAV-02-M5x12			
	●	●	40	37.5	350	27	≥50								
	●	●	50	47	400	35	≥63								

KAPR=93°

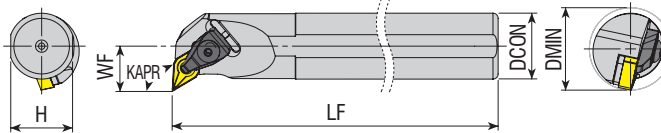

TDUNR

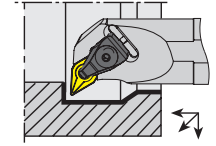

**Takım Kodu**  
**Ordering Code**  
**Bestell-Bezeichnung**

Stok Stock Lager	Takım Ölçüleri (mm) Dimension (mm) Abmessung (mm)						Kesici Uç Insert Wendeschneidplatte	Baskı Pabucu Wedge Clamp Spannpratze	Pabuç Vidası Clamp Screw Klemmschraube	Yedek Parçaları / Spare Parts / Ersatzteile					
	R	L	DCON	H	LF	WF				DMIN	Altlık Shim Unterlage	Altlık Vidası Shim Screw Schraube für Unterlage	Segman Ring Feder	Pul Stamp Ring	Anahtar Allen Key Innensechskantschlüssel
	●	●	25	23	250	17	≥32	DNM. 1104..	ATK-01	AKV-01-M5x22	AADN-2-0001	AAV-09-M5x9	-	ABPL-01	AAL-03-3
	●	●	32	30	300	22	≥40					AAV-04-M5x12			
	●	●	25	23	250	17	≥34	DNM. 1506..	ATK-02	AKV-30-M6x22	AADN-3-0001	AAV-13-M5x8	AS-01	ABPL-01	AAL-03-3
	●	●	32	30	300	22	≥40					AAV-02-M5x12			
	●	●	40	37.5	350	27	≥50								
	●	●	50	47	400	35	≥63								
<b>new</b>	●	●	40	37.5	300	27	≥50								

R: Sağ / Right / Rechts L: Sol / Left / Links

● Stokta / In Stock / Auf Lager ○ Stokta Yok / Non Stock Item / Kein Lagerartikel, Lieferzeit auf Anfrage

Sipariş Örneği/Ordering Example/Bestellbeispiel

1 ad./pcs./stück S25S TDQNR 11



www.akkо.com.tr

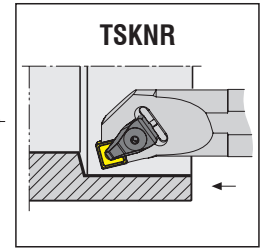
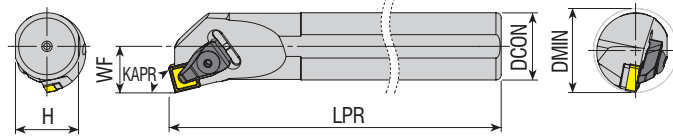

Takım Kodu Ordering Code Bestell-Bezeichnung	Stok Stock Lager		Takım Ölçüleri (mm) Dimension (mm) Abmessung (mm)					Kesici Uç Insert Wendeschneidplatte	Yedek Parçaları / Spare Parts / Ersatzteile						
	R	L	DCON	H	LPR	WF	DMIN		Baskı Pabucu Wedge Clamp Spannpratze	Pabuç Vidası Clamp Screw Klemmschraube	Altık Shim Unterlage	Altık Vidası Shim Screw Schraube für Unterlage	Segman Ring Feder	Pul Stamp Ring	Anahtar Allen Key Innensechskantschlüssel
S25S TSKNR/L 12	●	●	25	23	250	17	≥32	SNM. 1204..	ATK-02	AKV-30-M6x22	AASN -3-0004	AAV-13-M5x8	AS-01	ABPL-01	AAL-03-3
S32T TSKNR/L 12	●	●	32	30	300	22	≥40					AAV-02-M5x12			
S40U TSKNR/L 12	●	●	40	37.5	350	27	≥50								

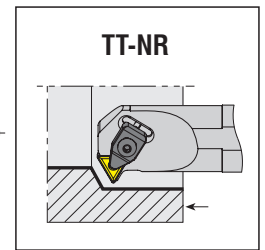
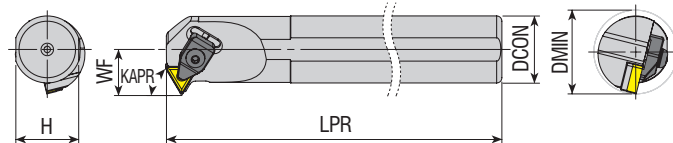
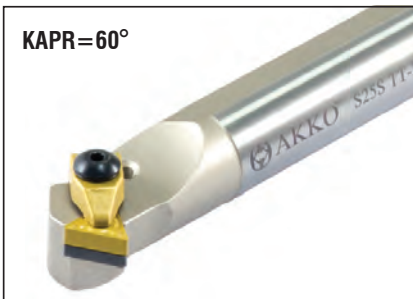

Takım Kodu Ordering Code Bestell-Bezeichnung	Stok Stock Lager		Takım Ölçüleri (mm) Dimension (mm) Abmessung (mm)					Kesici Uç Insert Wendeschneidplatte	Yedek Parçaları / Spare Parts / Ersatzteile						
	R	L	DCON	H	LPR	WF	DMIN		Baskı Pabucu Wedge Clamp Spannpratze	Pabuç Vidası Clamp Screw Klemmschraube	Altık Shim Unterlage	Altık Vidası Shim Screw Schraube für Unterlage	Yay Spring Пружина	Pul Stamp Ring	Anahtar Allen Key Innensechskantschlüssel
S25S TT-NR/L 16	●	●	25	23	250	17	≥32	TNM. 1604..	ATK-01	AKV-01-M5x22	AATN-2-0002	AAV-03-M5x12	-	ABPL-01	AAL-03-3
S32T TT-NR/L 16	●	●	32	30	300	22	≥40								

R: Sağ / Right / Rechts L: Sol / Left / Links  
● Stokta / In Stock / Auf Lager ○ Stokta Yok / Non Stock Item / Kein Lagerartikel, Lieferzeit auf Anfrage

Sipariş Örneği/Ordering Example/Bestellbeispiel  
1 ad./pcs./stück S25S TSKNR 12

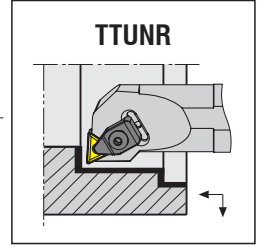
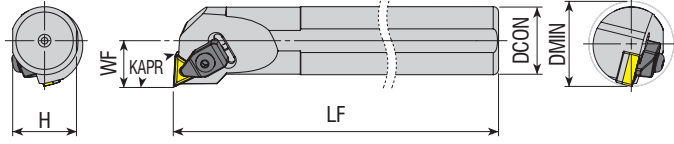

Takım Kodu Ordering Code Bestell-Bezeichnung	Stok Stock Lager		Takım Ölçüleri (mm) Dimension (mm) Abmessung (mm)					Kesici Uç Insert Wendeschneidplatte	Yedek Parçaları / Spare Parts / Ersatzteile						
	R	L	DCON	H	LF	WF	DMIN		Baskı Pabucu Wedge Clamp Spannpratze	Pabuç Vidası Clamp Screw Klemmschraube	Altlık Shim Unterlage	Altlık Vidası Shim Screw Schraube für Unterlage	Segman Ring Feder	Pul Stamp Ring	Anahtar Allen Key Innensechskantschlüssel
S25S TTUNR/L 16	●	●	25	23	250	17	≥32	TNM. 1604..	ATK-01	AKV-01-M5x22	AATN-2-0002	AAV-03-M5x12	-	ABPL-01	AAL-03-3
S32T TTUNR/L 16	●	●	32	30	300	22	≥40								
S25S TTUNR/L 22	●	●	25	23	250	17	≥32	TNM. 2204..	ATK-02	AKV-30-M6x22	AATN-3-0015	AAV-02-M5x12	AS-01	ABPL-01	AAL-03-3
S32T TTUNR/L 22	●	●	32	30	300	22	≥40								
S40U TTUNR/L 22	●	●	40	37.5	350	27	≥50								
S50V TTUNR/L 22	●	●	50	47	400	35	≥63								

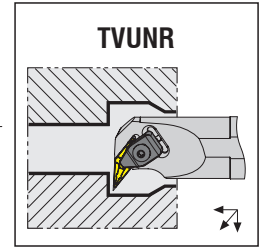
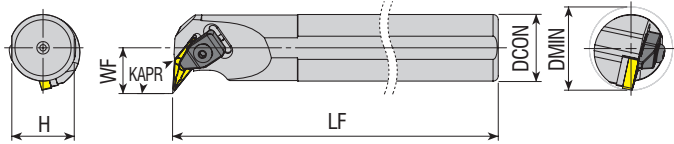
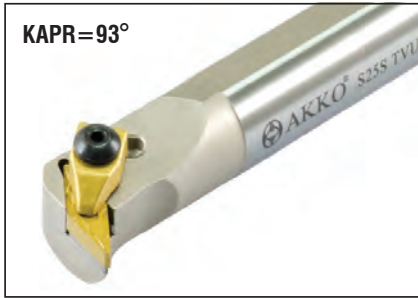

Takım Kodu Ordering Code Bestell-Bezeichnung	Stok Stock Lager		Takım Ölçüleri (mm) Dimension (mm) Abmessung (mm)					Kesici Uç Insert Wendeschneidplatte	Yedek Parçaları / Spare Parts / Ersatzteile						
	R	L	DCON	H	LF	WF	DMIN		Baskı Pabucu Wedge Clamp Spannpratze	Pabuç Vidası Clamp Screw Klemmschraube	Altlık Shim Unterlage	Altlık Vidası Shim Screw Schraube für Unterlage	Yay Spring Пружина	Pul Stamp Ring	Anahtar Allen Key Innensechskantschlüssel
S25S TVUNR/L 16	●	●	25	23	250	20	≥36	VNM. 1604..	ATK-01	AKV-01-M5x22	AAVN-2-0002	AAV-04-M5x12	-	ABPL-01	AAL-03-3
S32T TVUNR/L 16	●	●	32	30	300	22	≥40								
S40U TVUNR/L 16	●	●	40	37.5	350	27	≥50								

R: Sağ / Right / Rechts L: Sol / Left / Links

● Stokta / In Stock / Auf Lager ○ Stokta Yok / Non Stock Item / Kein Lagerartikel, Lieferzeit auf Anfrage

Sipariş Örneği/Ordering Example/Bestellbeispiel

1 ad./pcs./stück S25S TTUNR 16



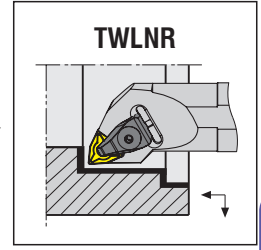
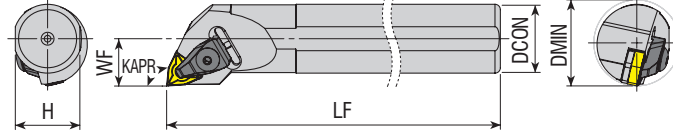

Takım Kodu Ordering Code Bestell-Bezeichnung	Stok Stock Lager		Takım Ölçüleri (mm) Dimension (mm) Abmessung (mm)					Kesici Uç Insert Wendeschneidplatte	Baskı Pabucu Wedge Clamp Spannpratze	Pabuç Vidası Clamp Screw Klemmschraube	Altlık Shim Unterlage	Altlık Vidası Shim Screw Schraube für Unterlage	Segman Ring Feder	Pul Stamp Ring	Anahtar Allen Key Innensechskantschlüssel
	R	L	DCON	H	LF	WF	DMIN								
S25S TWLNR/L 06	●	●	25	23	250	17	≥32	WNM. 0604..	ATK-01	AKV-01-M5x22	AAWN-SW317	AAV-01-M3x10	-		
S32T TWLNR/L 06	●	●	32	30	300	22	≥40					AAV-13-M5x8			
S25S TWLNR/L 08	●	●	25	23	250	17	≥32	WNM. 0804..	ATK-02	AKV-30-M6x22	AAWN-3-0001	AAV-02-M5x12	AS-01	ABPL-01	AAL-03-3
S32T TWLNR/L 08	●	●	32	30	300	22	≥40								
S40U TWLNR/L 08	●	●	40	37.5	350	27	≥50								
S50V TWLNR/L 08	●	●	50	47	400	35	≥63								
A40T TWLNR/L 08	●	○	40	37.5	300	27	≥50								
A50U TWLNR/L 08	●	○	50	47	350	35	≥63								

➤ C-SİSTEM DELİK TORNA KATERLERİ  
C-SYSTEM BORING BARS  
C-SYSTEM BOHRSTANGE

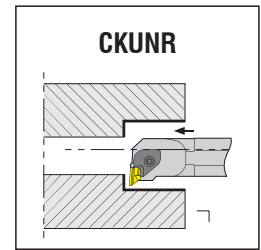
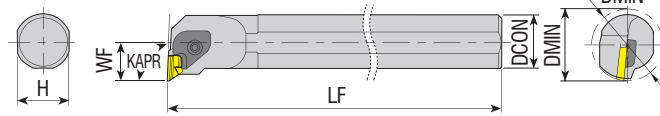
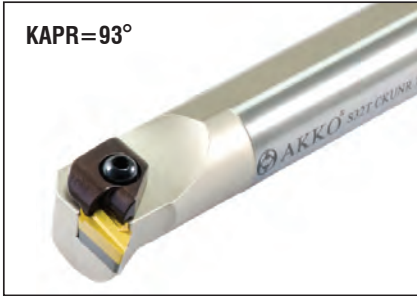

Takım Kodu Ordering Code Bestell-Bezeichnung	Stok Stock Lager		Takım Ölçüleri (mm) Dimension (mm) Abmessung (mm)					Kesici Uç Insert Wendeschneidplatte	Baskı Pabucu Wedge Clamp Spannpratze	Pabuç Vidası Clamp Screw Klemmschraube	Altlık Shim Unterlage	Altlık Vidası Shim Screw Schraube für Unterlage	Yay Spring Пружина	Pul Stamp Ring	Anahtar Allen Key Innensechskantschlüssel
	R	L	DCON	H	LF	WF	DMIN								
S25S CKUNR/L 16	●	●	25	23	250	19	≥38	KNUX 1604..	ACK-01-R ACK-02-L	AKV-06-M6x20	AKS-16-R AKS-16-L	AAV-01-M3x10	AKY-02	ABPL-01	AAL-05-4
S32T CKUNR/L 16	●	●	32	30	300	22	≥40								
S40U CKUNR/L 16	●	●	40	37.5	350	27	≥50								
S50V CKUNR/L 16	●	●	50	47	400	35	≥63								

R: Sağ / Right / Rechts L: Sol / Left / Links  
● Stokta / In Stock / Auf Lager ○ Stokta Yok / Non Stock Item / Kein Lagerartikel, Lieferzeit auf Anfrage

Sipariş Örneği/Ordering Example/Bestellbeispiel  
1 ad./pcs./stück S25S TWLNR 06

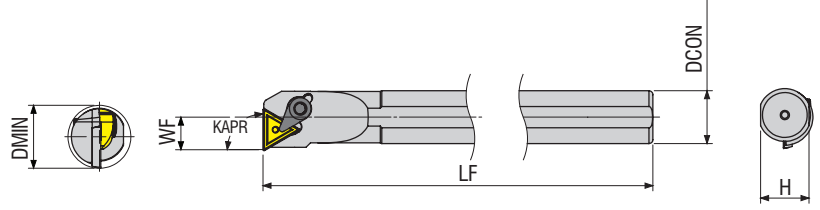

**Takım Kodu**  
**Ordering Code**  
**Bestell-Bezeichnung**

Stok Stock Lager		Takım Ölçüleri (mm) Dimension (mm) Abmessung (mm)					Kesici Uç Insert Wendeschneidplatte	Baskı Pabuçu Wedge Clamp Spannpratze	Pabuç Vidası Clamp Screw Klemmschraube	Altlık Shim Unterlage	Altlık Vidası Shim Screw Schraube für Unterlage	Segman Ring Feder	Pul Stamp Ring	Anahtar Allen Key Innerschraubenschlüssel
R	L	DCON	H	LF	WF	DMIN								
●	○	16	14.7	200	11	22	TP.. 1603..	ACK-06	AKV-10-M6X14	-	-	-	-	AAL-05-4
●	○	20	18.3	250	13	24								
●	○	25	23	300	17	32								

R: Sağ / Right / Rechts L: Sol / Left / Links

● Stokta / In Stock / Auf Lager ○ Stokta Yok / Non Stock Item / Kein Lagerartikel, Lieferzeit auf Anfrage

Sipariş Örneği/Ordering Example/Bestellbeispiel

1 ad./pcs./stück S16R CTFPR 16

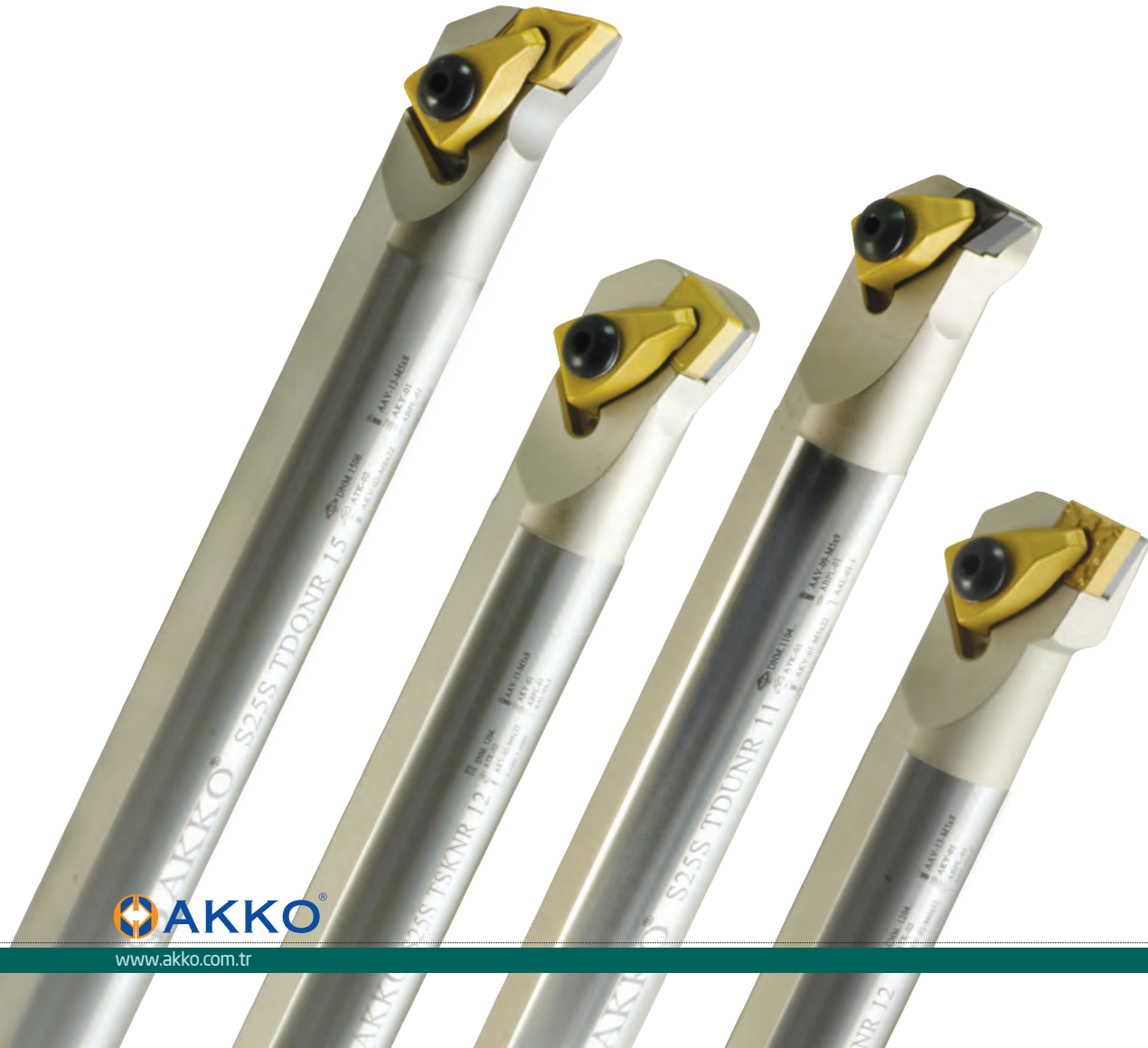



# M-SİSTEM

M-SİSTEM DELİK TORNA KATERLERİ  
M-SYSTEM BORING BARS  
M-SYSTEM BOHRSTANGE

*konusulan*  
*the spoken kalite...*  
*quality...*





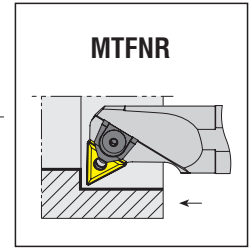
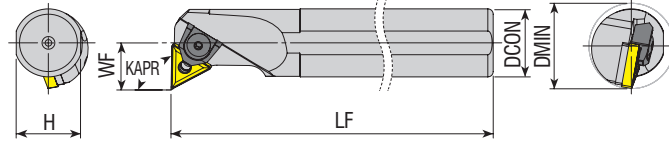
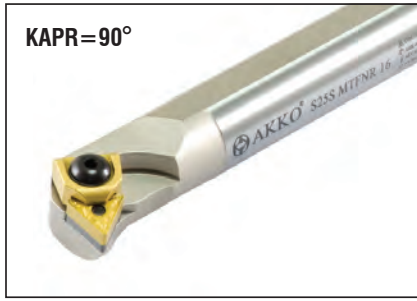

Takım Kodu Ordering Code Bestell-Bezeichnung	Stok Stock Lager		Takım Ölçüleri (mm) Dimension (mm) Abmessung (mm)				Kesici Uç Insert Wendeschneidplatte	Baskı Pabucu Wedge Clamp Spannpratze	Pabuç Vidası Clamp Screw Klemmschraube	Yedek Parçaları / Spare Parts / Ersatzteile					
	R	L	DCON	H	LF	WF				DMIN	Altık Shim Unterlage	Pim Pin Штифт	Segman Ring Feder	Pul Stamp Ring	Anahtar Allen Key Innenschlüssel
<b>S20R MTFNR/L 16</b>	●	●	20	18.3	200	14	≥25	TNM. 1604..	AMK-02	AKV-17-M5x15	-	APM-03	-	-	AAL-03-3
<b>S25S MTFNR/L 16</b>	●	●	25	23	250	17	≥32				AATN-2-0002	APM-14			
<b>S32T MTFNR/L 16</b>	●	●	32	30	300	22	≥40					APM-01	AS-01	ABPL-01	
<b>S40U MTFNR/L 16</b>	●	●	40	37.5	350	27	≥50		AMK-04	AKV-30-M6x22					
<b>S32T MTFNR/L 22</b>	●	●	32	30	300	22	≥40	TNM. 2204..			AATN-3-0015	APM-02			
<b>S40U MTFNR/L 22</b>	●	●	40	37.5	350	27	≥50								
<b>S50V MTFNR/L 22</b>	●	○	50	47	400	35	≥63								

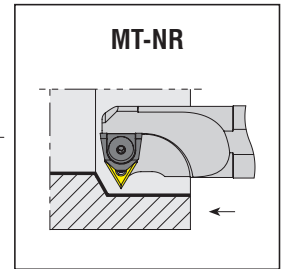
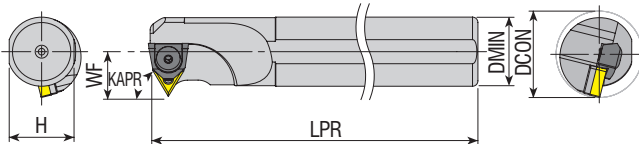

Takım Kodu Ordering Code Bestell-Bezeichnung	Stok Stock Lager		Takım Ölçüleri (mm) Dimension (mm) Abmessung (mm)				Kesici Uç Insert Wendeschneidplatte	Baskı Pabucu Wedge Clamp Spannpratze	Pabuç Vidası Clamp Screw Klemmschraube	Yedek Parçaları / Spare Parts / Ersatzteile					
	R	L	DCON	H	LPR	WF				DMIN	Altık Shim Unterlage	Pim Pin Штифт	Segman Ring Feder	Pul Stamp Ring	Anahtar Allen Key Innenschlüssel
<b>S20R MT-NR/L 16</b>	●	●	20	18.3	200	16	≥26	TNM. 1604..	AMK-02	AKV-04-M5x17	-	APM-03	-	-	AAL-03-3
<b>S25S MT-NR/L 16</b>	●	●	25	23	250	17	≥32				AATN-2-0002	APM-14			
<b>S32T MT-NR/L 16</b>	●	●	32	30	300	22	≥40					APM-01	AS-01	ABPL-01	
<b>S40U MT-NR/L 16</b>	●	●	40	37.5	350	27	≥50		AMK-04	AKV-30-M6x22					
<b>S32T MT-NR/L 22</b>	●	●	32	30	300	24	≥40	TNM. 2204..			AATN-3-0015	APM-02			
<b>S40U MT-NR/L 22</b>	●	●	40	37.5	350	27	≥50								
<b>S50U MT-NR/L 22</b>	●	●	50	47	350	35	≥63								

R: Sağ / Right / Rechts L: Sol / Left / Links  
● Stokta / In Stock / Auf Lager ○ Stokta Yok / Non Stock Item / Kein Lagerartikel, Lieferzeit auf Anfrage

Sipariş Örneği/Ordering Example/Bestellbeispiel  
1 ad./pcs./stück S20R MTFNR 16

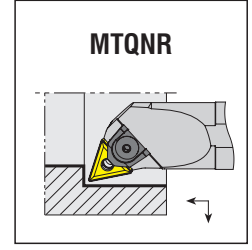
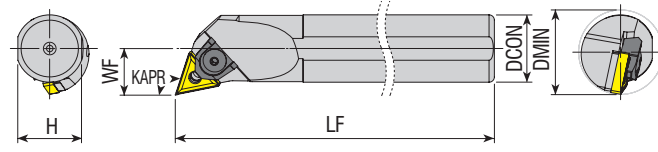

Takım Kodu Ordering Code Bestell-Bezeichnung	Stok Stock Lager		Takım Ölçüleri (mm) Dimension (mm) Abmessung (mm)				Kesici Uç Insert Wendeschneidplatte	Baskı Pabucu Wedge Clamp Spannpratze	Pabuç Vidası Clamp Screw Klemmschraube	Altlık Shim Unterlage	Pim Pin Штифт	Segman Ring Feder	Pul Stamp Ring	Anahtar Allen Key Innensechskantschlüssel	
	R	L	DCON	H	LF	WF									DMIN
<b>S20R MTQNR/L 16</b>	●	●	20	18.3	200	13	≥25	TNM. 1604..	AMK-02	AKV-17-M5x15	-	APM-11	-	-	AAL-03-3
<b>S25S MTQNR/L 16</b>	●	●	25	23	250	17	≥32				AATN-2-0002	APM-14			
<b>S32T MTQNR/L 16</b>	●	●	32	30	300	22	≥40					APM-01			
<b>S40U MTQNR/L 16</b>	●	●	40	37.5	350	27	≥50	TNM. 2204..	AMK-04	AKV-30-M6x22			AS-01	ABPL-01	
<b>S32T MTQNR/L 22</b>	●	●	32	30	300	22	≥40				AATN-3-0015	APM-02			
<b>S40U MTQNR/L 22</b>	●	●	40	37.5	350	27	≥50								
<b>S50V MTQNR/L 22</b>	●	●	50	47	400	35	≥63								

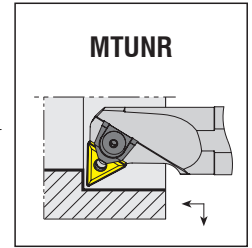
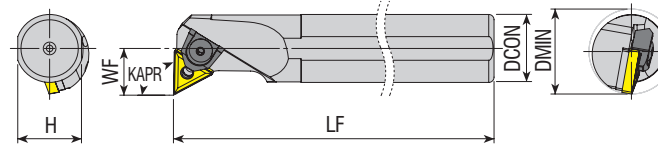
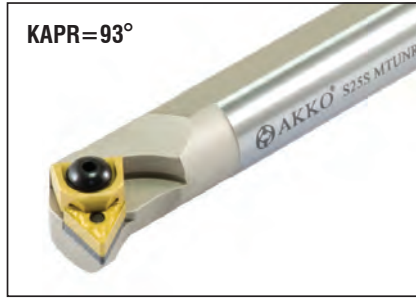

Takım Kodu Ordering Code Bestell-Bezeichnung	Stok Stock Lager		Takım Ölçüleri (mm) Dimension (mm) Abmessung (mm)				Kesici Uç Insert Wendeschneidplatte	Baskı Pabucu Wedge Clamp Spannpratze	Pabuç Vidası Clamp Screw Klemmschraube	Altlık Shim Unterlage	Pim Pin Штифт	Segman Ring Feder	Pul Stamp Ring	Anahtar Allen Key Innensechskantschlüssel	
	R	L	DCON	H	LF	WF									DMIN
<b>S20R MTUNR/L 16</b>	●	●	20	18.3	200	13	≥25	TNM. 1604..	AMK-02	AKV-17-M5x15	-	APM-03	-	-	AAL-03-3
<b>S25S MTUNR/L 16</b>	●	●	25	23	250	17	≥32				AATN-2-0002	APM-14			
<b>S32T MTUNR/L 16</b>	●	●	32	30	300	22	≥40					APM-01			
<b>S40U MTUNR/L 16</b>	●	●	40	37.5	350	27	≥50	TNM. 2204..	AMK-04	AKV-30-M6x22			AS-01	ABPL-01	
<b>S50V MTUNR/L 16</b>	●	●	50	47	400	35	≥63				AATN-3-0015	APM-02			
<b>S32T MTUNR/L 22</b>	●	●	32	30	300	22	≥40								
<b>S40U MTUNR/L 22</b>	●	●	40	37.5	350	27	≥50								
<b>S50V MTUNR/L 22</b>	●	●	50	47	400	35	≥63								

R: Sağ / Right / Rechts L: Sol / Left / Links

● Stokta / In Stock / Auf Lager ○ Stokta Yok / Non Stock Item / Kein Lagerartikel, Lieferzeit auf Anfrage

Sipariş Örneği/Ordering Example/Bestellbeispiel

1 ad./pcs./stück S20R MTQNR 16

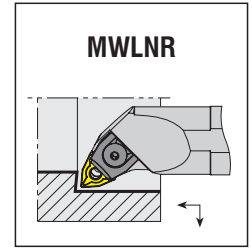
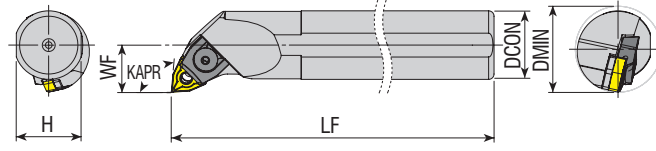

Takım Kodu Ordering Code Bestell-Bezeichnung	Stok Stock Lager		Takım Ölçüleri (mm) Dimension (mm) Abmessung (mm)				Kesici Uç Insert Wendeschneidplatte	Baskı Pabucu Wedge Clamp Spannpratze	Pabuç Vidası Clamp Screw Klemmschraube	Yedek Parçaları / Spare Parts / Ersatzteile					
	R	L	DCON	H	LF	WF				DMIN	Altık Shim Unterlage	Pim Pin Штифт	Segman Ring Feder	Pul Stamp Ring	Anahtar Allen Key Innenschraubenschlüssel
<b>S16P MWLNR/L 06</b>	●	●	16	14.8	170	11	≥20	WNM. 0604..	AMK-01	AKV-17-M5x15	-	APM-09	-	-	
<b>S20R MWLNR/L 06</b>	●	●	20	18.3	200	13	≥25			AKV-04-M5x17		APM-10			
<b>S25S MWLNR/L 06</b>	●	●	25	23	250	17	≥32			AKV-04-M5x17		APM-08			
<b>S25S MWLNR/L 08</b>	●	●	25	23	250	17	≥32	WNM. 0804..	AMK-05	AKV-27-M6x20	AAWN-3-0001	APM-04	AS-01	ABPL-01	AAL-03-3
<b>S20R MWLNR/L 08</b>	●	●	20	18.3	200	13	≥25			AKV-03-M6x22		APM-02			
<b>S32T MWLNR/L 08</b>	●	●	32	30	300	22	≥40								
<b>S40U MWLNR/L 08</b>	●	●	40	37.5	350	27	≥50								

R: Sağ / Right / Rechts L: Sol / Left / Links  
● Stokta / In Stock / Auf Lager ○ Stokta Yok / Non Stock Item / Kein Lagerartikel, Lieferzeit auf Anfrage

Sipariş Örneği/Ordering Example/Bestellbeispiel  
1 ad./pcs./stück S16P MWLNR 06





*konusulan  
the spoken kalite...  
quality...*

# P-SİSTEM

**P-SİSTEM DELİK TORNA KATERLERİ**  
*P-SYSTEM BORING BARS*  
*P-SYSTEM BOHRSTANGE*





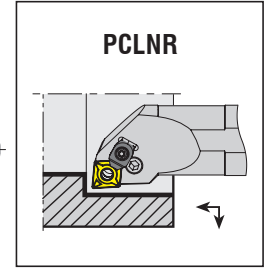
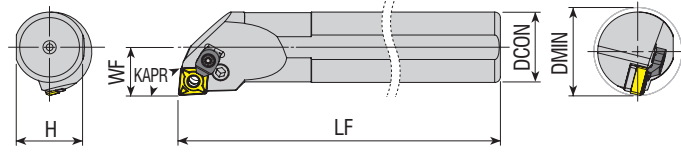

Takım Kodu Ordering Code Bestell-Bezeichnung	Stok Stock Lager		Takım Ölçüleri (mm) Dimension (mm) Abmessung (mm)				Kesici Uç Insert Wendeschneidplatte	Yedek Parçaları / Spare Parts / Ersatzteile							
	R	L	DCON	H	LF	WF		DMIN	Levyeye Lever Kniehebel	Levyeye Vidası Lever Screw Kniehebelschraube	Altık Shim Unterlage	Altık Yay Shim Spring Feder für Unterlage	Baskı Pabucu Wedge Clamp Spannpratze	Pabuç Vidası Clamp Screw Klemmschraube	Anahtar Allen Key Innensechskantschlüssel
S16P PCLNR/L 09	●	●	16	14.8	170	11	≥20	CNM. 0903..	APL-07	ALV-07-M6x13	-	AAY-07	-	-	AAL-02-2.5
S20R PCLNR/L 09	●	●	20	18.3	200	13	≥25		APL-01	ALV-01-M6x14	AACN-2-0002	AAY-01	-	-	AAL-02-2.5
S25S PCLNR/L 09	●	○	25	23	250	17	≥32			ALV-08-M8x16					
S25S PCLNR/L 12C	●	●	25	23	250	17	≥32	CNM. 1204..	APL-02	ALV-03-M8x19	AACN-3-0001	AAY-02	ACK-05	4015-M4x11	AAL-03-3
S32T PCLNR/L 12C	●	●	32	30	300	22	≥40								
S40U PCLNR/L 12C	●	●	40	37.5	350	27	≥50								
S50V PCLNR/L 12C	●	●	50	47	400	35	≥63	CNM. 1606..	APL-04	ALV-04-M8x22	AACN-3-0002	AAY-03	ACK-09	AAV-05-M6x15	AAL-05-4
S32T PCLNR/L 16C	●	●	32	30	300	22	≥40								
S40U PCLNR/L 16C	●	●	40	37.5	350	27	≥50								
S50V PCLNR/L 16C	●	●	50	47	400	35	≥63	CNM. 1906..	APL-05	ALV-05-M10x27	AACN-3-0003	AAY-04	ACK-09	AAV-05-M6x15	AAL-05-4
S40U PCLNR/L 19C	●	●	40	37.5	350	27	≥50								
S50V PCLNR/L 19C	●	●	50	47	400	35	≥63								
A20P PCLNR/L 09	●	●	20	18.3	170	13	≥25	CNM. 0903..	APL-01	ALV-01-M6x17	AACN-2-0002	AAY-01	-	-	AAL-02-2.5
A25R PCLNR/L 12C	●	●	25	23	200	17	≥32								
A25S PCLNR/L 12C	●	○	25	23	250	17	≥32								
A32S PCLNR/L 12C	●	●	32	30	250	22	≥40	CNM. 1204..	APL-02	ALV-03-M8x19	AACN-3-0001	AAY-02	ACK-05	4015-M4x11	AAL-03-3
A32S PCLNR/L 12C	●	●	32	30	250	22	≥40								
A32T PCLNR/L 12C	○	●	32	30	300	22	≥40								
A40T PCLNR/L 12C	●	●	40	37.5	300	27	≥50	CNM. 1606..	APL-04	ALV-04-M8x22	AACN-3-0002	AAY-03	ACK-09	AAV-05-M6x15	AAL-05-4
A40T PCLNR/L 12C	●	●	40	37.5	300	27	≥50								
A40T PCLNR/L 12C	●	●	40	37.5	300	27	≥50								
A50U PCLNR/L 12C	●	●	50	47	350	35	≥63	CNM. 1906..	APL-05	ALV-05-M10x27	AACN-3-0003	AAY-04	ACK-09	AAV-05-M6x15	AAL-05-4
A32S PCLNR/L 16C	●	●	32	30	250	22	≥40								
A40T PCLNR/L 16C	●	●	40	37.5	300	27	≥50								
A50U PCLNR/L 16C	●	●	50	47	350	35	≥63	CNM. 1906..	APL-05	ALV-05-M10x27	AACN-3-0003	AAY-04	ACK-09	AAV-05-M6x15	AAL-05-4
A40T PCLNR/L 19C	●	●	40	37.5	300	27	≥50								
A50U PCLNR/L 19C	●	●	50	47	350	35	≥63								

R: Sağ / Right / Rechts L: Sol / Left / Links

● Stokta / In Stock / Auf Lager ○ Stokta Yok / Non Stock Item / Kein Lagerartikel, Lieferzeit auf Anfrage

Sipariş Örneği/Ordering Example/Bestellbeispiel

1 ad./pcs./stück S16P PCLNR 09

KAPR=107.5°

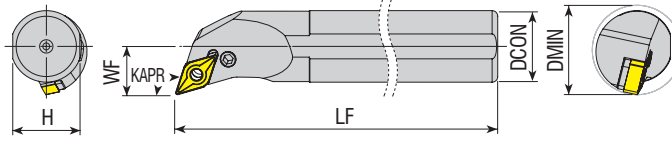

PDQNR

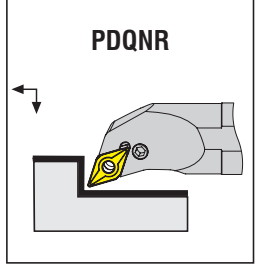

Takım Kodu Ordering Code Bestell-Bezeichnung	Stok Stock Lager		Takım Ölçüleri (mm) Dimension (mm) Abmessung (mm)					Kesici Uç Insert Wendeschneidplatte	Levye Lever Kniehebel	Levye Vidası Lever Screw Kniehebelschraube	Yedek Parçaları / Spare Parts / Ersatzteile					
	R	L	DCON	H	LF	WF	DMIN				Altılık Shim Unterlage	Altılık Yayı Shim Spring Feder für Unterlage	Baskı Pabucu Wedge Clamp Spannpratze	Pabuç Vidası Clamp Screw Klemmschraube	Anahtar Allen Key Innensechskantschlüssel	
S20R PDQNR/L 11	●	○	20	18.3	200	13	≥25	DNM. 1104..	APL-01	ALV-01-M6x14 ALV-02-M6x17	AADN-SD317	AAY-01			AAL-02-2.5	
S25S PDQNR/L 11	●	●	25	23	250	17	≥32									
S32T PDQNR/L 15	●	●	32	30	300	22	≥40	DNM. 1506..	APL-03	ALV-03-M8x19	AADN-3-0001	AAY-02	-	-	AAL-03-3	
S40U PDQNR/L 15	●	●	40	37.5	350	27	≥50									
S50V PDQNR/L 15	●	●	50	47	400	35	≥63	DNM. 1504..	APL-03	ALV-03-M8x19	AADN-2-0003	AAY-02	-	-	AAL-03-3	
S32T PDQNR/L 1504	●	●	32	30	300	22	≥40									
S40U PDQNR/L 1504	●	●	40	37.5	350	27	≥50	DNM. 1504..	APL-03	ALV-03-M8x19	AADN-2-0003	AAY-02	-	-	AAL-03-3	
S50V PDQNR/L 1504	●	●	50	47	400	35	≥63									
A20P PDQNR/L 11	●	●	20	18.3	170	13	≥25	DNM. 1104..	APL-01	ALV-01-M6x14 ALV-02-M6x17	AADN-SD317	AAY-01	-	-	AAL-02-2.5	
A25R PDQNR/L 11	●	●	25	23	200	17	≥32									
A32S PDQNR/L 15	●	●	32	30	250	22	≥40	DNM. 1506..	APL-03	ALV-03-M8x19	AADN-3-0001	AAY-02	-	-	AAL-03-3	
A40T PDQNR/L 15	●	●	40	37.5	300	27	≥50									
A50U PDQNR/L 15	●	●	50	47	350	35	≥63	DNM. 1504..	APL-03	ALV-03-M8x19	AADN-2-0003	AAY-02	-	-	AAL-03-3	
A32S PDQNR/L 1504	●	●	32	30	250	22	≥40									
A40T PDQNR/L 1504	●	●	40	37.5	300	27	≥50									

KAPR=93°

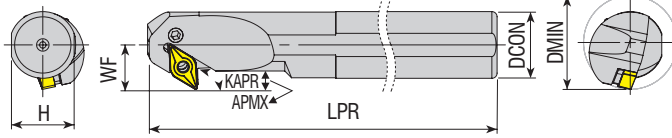

PDXNR

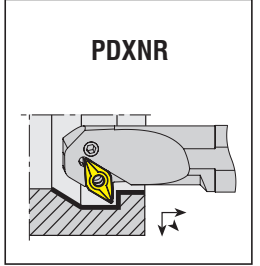

Takım Kodu Ordering Code Bestell-Bezeichnung	Stok Stock Lager		Takım Ölçüleri (mm) Dimension (mm) Abmessung (mm)						Kesici Uç Insert Wendeschneidplatte	Levye Lever Kniehebel	Levye Vidası Lever Screw Kniehebelschraube	Yedek Parçaları / Spare Parts / Ersatzteile					
	R	L	DCON	H	LPR	WF	APMX	DMIN				Altılık Shim Unterlage	Altılık Yayı Shim Spring Feder für Unterlage	Baskı Pabucu Wedge Clamp Spannpratze	Pabuç Vidası Clamp Screw Klemmschraube	Anahtar Allen Key Innensechskantschlüssel	
S32T PDXNR/L 15	●	●	32	30	300	22	12	≥45	DNM. 1506..	APL-03	ALV-08-M8x16 ALV-03-M8x19 ALV-08-M8x16 ALV-03-M8x19	AADN-3-0001	AAY-02	-	-	AAL-03-3	
S40U PDXNR/L 15	●	●	40	37.5	350	27	14	≥50									
S50V PDXNR/L 15	●	●	50	47	400	35	19	≥63									
A32S PDXNR/L 15	●	●	32	30	250	22	12	≥40									
A40T PDXNR/L 15	●	●	40	37.5	300	27	14	≥50									
A50U PDXNR/L 15	●	●	50	47	350	35	19	≥63									

R: Sağ / Right / Rechts L: Sol / Left / Links

● Stokta / In Stock / Auf Lager ○ Stokta Yok / Non Stock Item / Kein Lagerartikel, Lieferzeit auf Anfrage

Not: "APMX" ölçüleri R0.8'e göre verilmiştir. Note: Dimensions of "AMPX" are given according to R0.8. Hinweis: Maß "APMX" gilt für Eckenradius 0,8 mm

Sipariş Örneği/Ordering Example/Bestellbeispiel

1 ad./pcs./stück S20R PDQNR 11

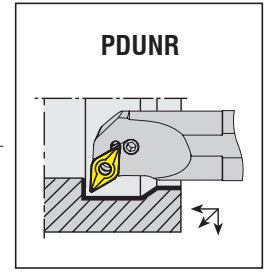
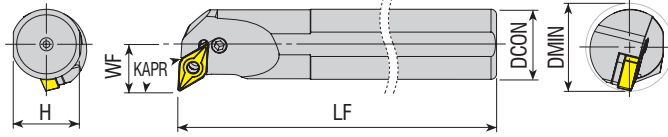
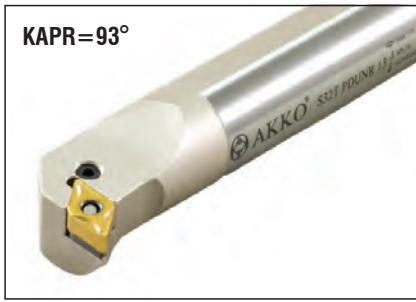

Takım Kodu Ordering Code Bestell-Bezeichnung	Stok Stock Lager		Takım Ölçüleri (mm) Dimension (mm) Abmessung (mm)					Kesici Uç Insert Wendeschneidplatte	Yedek Parçaları / Spare Parts / Ersatzteile						
	R	L	DCON	H	LF	WF	DMIN		Levyé Lever Kniehebel	Levyé Vidası Lever Screw Kniehebelschraube	Altılık Shim Unterlage	Altılık Yayı Shim Spring Feder für Unterlage	Baskı Pabucu Wedge Clamp Spannpratze	Pabuç Vidası Clamp Screw Klemmschraube	Anahtar Allen Key Innensechskantschlüssel
S20R PDUNR/L 11	●	●	20	18.3	200	13	≥25	DNM. 1104..	APL-01	ALV-01-M6x14 ALV-02-M6x17 ALV-08-M8x16	AADN-SD317	AAY-01	-	-	AAL-02-2.5
S25S PDUNR/L 11	●	●	25	23	250	17	≥32								
S25S PDUNR/L 15	●	●	25	23	250	19	≥32								
S32T PDUNR/L 15	●	●	32	30	300	22	≥40	DNM. 1506..	APL-03	ALV-03-M8x19	AADN-3-0001	AAY-02	-	-	AAL-03-3
S40U PDUNR/L 15	●	●	40	37.5	350	27	≥50								
S50V PDUNR/L 15	●	●	50	47	400	35	≥63	DNM. 1104..	APL-01	ALV-01-M6x14 ALV-02-M6x17	AADN-SD317	AAY-01	-	-	AAL-02-2.5
A20P PDUNR/L 11	●	●	20	18.3	170	13	≥25								
A25R PDUNR/L 11	●	●	25	23	200	17	≥32								
new A25S PDUNR/L 11	●	○	25	23	250	17	≥32	DNM. 1506..	APL-03	ALV-03-M8x19	AADN-3-0001	AAY-02	-	-	AAL-03-3
A32S PDUNR/L 11	●	●	32	30	250	22	≥40								
A32S PDUNR/L 15	●	●	32	30	250	22	≥40	DNM. 1506..	APL-03	ALV-03-M8x19	AADN-3-0001	AAY-02	-	-	AAL-03-3
A40T PDUNR/L 15	●	●	40	37.5	300	27	≥50								
A50U PDUNR/L 15	●	●	50	47	350	35	≥63								

R: Sağ / Right / Rechts L: Sol / Left / Links

● Stokta / In Stock / Auf Lager ○ Stokta Yok / Non Stock Item / Kein Lagerartikel, Lieferzeit auf Anfrage

Sipariş Örneği/Ordering Example/Bestellbeispiel

1 ad./pcs./stück S20R PDUNR 11



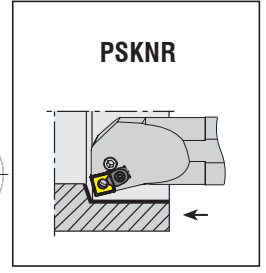
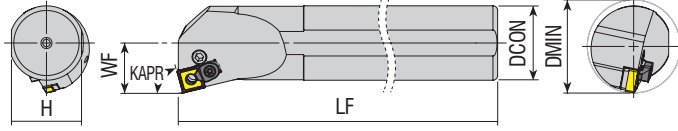

Takım Kodu Ordering Code Bestell-Bezeichnung	Stok Stock Lager		Takım Ölçüleri (mm) Dimension (mm) Abmessung (mm)				Kesici Uç Insert Wendeschneidplatte	Levyeye Lever Kniehebel	Levyeye Vidası Lever Screw Kniehebelschraube	Yedek Parçaları / Spare Parts / Ersatzteile					
	R	L	DCON	H	LF	WF				DMIN	Altılık Shim Unterlage	Altılık Yayını Shim Spring Feder für Unterlage	Baskı Pabuçunu Wedge Clamp Spannpratze	Pabuç Vidasını Clamp Screw Klemmschraube	Anahtar Allen Key Innensechskantschlüssel
S25S PSKNR/L 12C	●	●	25	23	250	17	≥32	SNM. 1204..	APL-02	ALV-08-M8x16	AASN-3-0004	AAY-02	ACK-05	4015-M4x11	AAL-03-3
S32T PSKNR/L 12C	●	●	32	30	300	22	≥40								
S40U PSKNR/L 12C	●	●	40	37.5	350	27	≥50								
S50V PSKNR/L 12C	●	●	50	47	400	35	≥63								
S32T PSKNR/L 15C	○	○	32	30	300	22	≥40	SNM. 1506..	APL-04	ALV-04-M8x22	AASN-3-0023	AAY-03	ACK-09	AAV-05-M6x15	
S40U PSKNR/L 15C	○	○	40	37.5	350	27	≥50								
S50V PSKNR/L 15C	○	○	50	47	400	35	≥63								
A25R PSKNR/L 12C	●	●	25	23	200	17	≥32	SNM. 1204..	APL-02	ALV-08-M8x16	AASN-3-0004	AAY-02	ACK-05	4015-M4x11	
A32S PSKNR/L 12C	●	●	32	30	250	22	≥40								
A40T PSKNR/L 12C	●	●	40	37.5	300	27	≥50								
A50U PSKNR/L 12C	○	○	50	47	350	35	≥63								
A32S PSKNR/L 15C	●	●	32	30	250	22	≥40	SNM. 1506..	APL-04	ALV-04-M8x22	AASN-3-0023	AAY-03	ACK-09	AAV-05-M6x15	
A40T PSKNR/L 15C	●	●	40	37.5	300	27	≥50								
A50U PSKNR/L 15C	●	●	50	47	350	35	≥63								

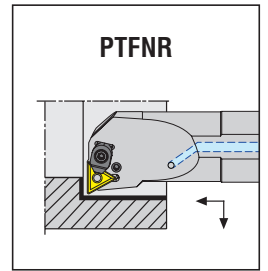
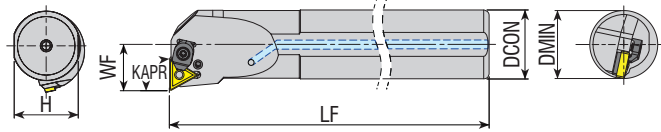

Takım Kodu Ordering Code Bestell-Bezeichnung	Stok Stock Lager		Takım Ölçüleri (mm) Dimension (mm) Abmessung (mm)				Kesici Uç Insert Wendeschneidplatte	Levyeye Lever Kniehebel	Levyeye Vidası Lever Screw Kniehebelschraube	Yedek Parçaları / Spare Parts / Ersatzteile					
	R	L	DCON	H	LF	WF				DMIN	Altılık Shim Unterlage	Altılık Yayını Shim Spring Feder für Unterlage	Baskı Pabuçunu Wedge Clamp Spannpratze	Pabuç Vidasını Clamp Screw Klemmschraube	Anahtar Allen Key Innensechskantschlüssel
A25R PTFNR/L 16C	●	●	25	23	200	17	≥32	TNM. 1604..	APL-01	ALV-02-M6x17	AATN-3-0025	AAY-01	ACK-05	4015-M4x11	AAL-03-3
A32S PTFNR/L 16C	●	●	32	30	250	22	≥40								

R: Sağ / Right / Rechts L: Sol / Left / Links

● Stokta / In Stock / Auf Lager ○ Stokta Yok / Non Stock Item / Kein Lagerartikel, Lieferzeit auf Anfrage

Sipariş Örneği/Ordering Example/Bestellbeispiel

1 ad./pcs./stück S25S PSKNR 12C

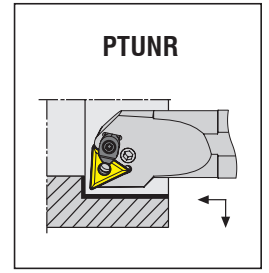
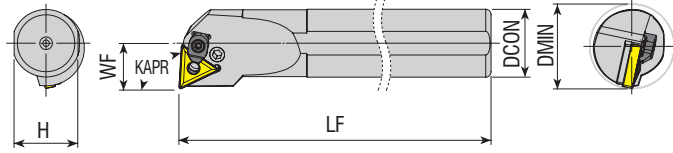

Takım Kodu Ordering Code Bestell-Bezeichnung	Stok Stock Lager		Takım Ölçüleri (mm) Dimension (mm) Abmessung (mm)					Kesici Uç Insert Wendeschneidplatte	Yedek Parçaları / Spare Parts / Ersatzteile						
	R	L	DCON	H	LF	WF	DMIN		Levyé Lever Kniehebel	Levyé Vidası Lever Screw Kniehebelschraube	Altılık Shim Unterlage	Altılık Yayı Shim Spring Feder für Unterlage	Baskı Pabucu Wedge Clamp Spannpratze	Pabuç Vidası Clamp Screw Klemmschraube	Anahtar Allen Key Innereckschlüssel
<b>S16P PTUNR/L 16</b>	●	●	16	14.8	170	11	≥20	<b>TNM. 1604..</b>	APL-08	ALV-07-M6x13	-	AAY-07	-	-	AAL-02-2.5
<b>S20R PTUNR/L 16</b>	●	●	20	18.3	200	13	≥25		APL-01	ALV-01-M6x14	AATN-3-0025	AAY-01	ACK-05	4015-M4x11	
<b>S25S PTUNR/L 16C</b>	●	●	25	23	250	17	≥32		APL-01	ALV-02-M6x17					
<b>S32T PTUNR/L 16C</b>	●	●	32	30	300	22	≥40		APL-01	ALV-02-M6x17					
<b>S40U PTUNR/L 16C</b>	●	●	40	37.5	350	27	≥50		APL-01	ALV-02-M6x17					
<b>S32T PTUNR/L 22C</b>	●	●	32	30	300	22	≥40	<b>TNM. 2204..</b>	APL-02	ALV-03-M8x19					AATN-3-0015
<b>S40U PTUNR/L 22C</b>	●	●	40	37.5	350	27	≥50		APL-02	ALV-03-M8x19	AATN-3-0015	AAY-02	ACK-05	4015-M4x11	AAL-03-3
<b>S50V PTUNR/L 22C</b>	●	●	50	47	400	35	≥63		APL-02	ALV-03-M8x19	AATN-3-0015	AAY-02	ACK-05	4015-M4x11	AAL-03-3
<b>A16M PTUNR/L 16</b>	●	●	16	14.8	150	11	≥20	<b>TNM. 1604..</b>	APL-08	ALV-07-M6x13	-	AAY-07	-	-	AAL-02-2.5
<b>A20P PTUNR/L 16</b>	●	●	20	18.3	170	13	≥25		APL-01	ALV-01-M6x14	AATN-3-0025	AAY-01	ACK-05	4015-M4x11	
<b>A25R PTUNR/L 16C</b>	●	●	25	23	200	17	≥32		APL-01	ALV-02-M6x17					
<b>A32S PTUNR/L 16C</b>	●	●	32	30	250	22	≥40		APL-01	ALV-02-M6x17					
<b>A40T PTUNR/L 16C</b>	●	●	40	37.5	300	27	≥50		APL-01	ALV-02-M6x17					
<b>A32S PTUNR/L 22C</b>	●	●	32	30	250	22	≥40	<b>TNM. 2204..</b>	APL-02	ALV-03-M8x19					AATN-3-0015
<b>A40T PTUNR/L 22C</b>	●	●	40	37.5	300	27	≥50		APL-02	ALV-03-M8x19	AATN-3-0015	AAY-02	ACK-05	4015-M4x11	AAL-03-3

R: Sağ / Right / Rechts L: Sol / Left / Links

● Stokta / In Stock / Auf Lager ○ Stokta Yok / Non Stock Item / Kein Lagerartikel, Lieferzeit auf Anfrage

Sipariş Örneği/Ordering Example/Bestellbeispiel

1 ad./pcs./stück S16P PTUNR 16



P-SİSTEM DELİK TORNA KATERLERİ

P-SYSTEM BORING BARS  
P-SYSTEM BOHRSTANGE

KAPR=95°

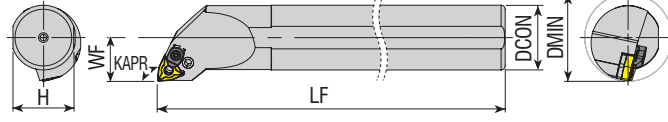

PWLNR

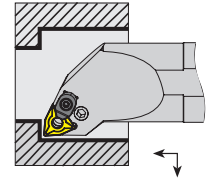

Takım Kodu  
Ordering Code  
Bestell-Bezeichnung

Yedek Parçaları / Spare Parts / Ersatzteile

Takım Kodu Ordering Code Bestell-Bezeichnung	Stok Stock Lager		Takım Ölçüleri (mm) Dimension (mm) Abmessung (mm)				Kesici Uç Insert Wendeschneidplatte	Levye Lever Kniehebel	Levye Vidası Lever Screw Kniehebelschraube	Altlık Shim Unterlage	Altlık Yay Shim Spring Feder für Unterlage	Baskı Pabucu Wedge Clamp Spannpratze	Pabuç Vidası Clamp Screw Klemmschraube	Anahtar Allen Key Innerschraubschlüssel	
	R	L	DCON	H	LF	WF	DMIN								
S20R PWLNR/L 06	●	●	20	18.3	200	13	≥25	WNM. 0604..	APL-01	ALV-01-M6x14	AAWN-SW317	AAY-01	-	-	AAL-02-2.5
S25S PWLNR/L 06	●	●	25	23	250	17	≥32								
S32T PWLNR/L 06	●	●	32	30	300	22	≥40								
S25S PWLNR/L 08C	●	●	25	23	250	17	≥32	WNM. 0804..	APL-02	ALV-03-M8x19	AAWN-3-0001	AAY-02	ACK-05	4015-M4x11	AAL-03-3
S32T PWLNR/L 08C	●	●	32	30	300	22	≥40								
S40U PWLNR/L 08C	●	●	40	37.5	350	27	≥50								
S50V PWLNR/L 08C	●	●	50	47	400	35	≥63	WNM. 0604..	APL-08	ALV-07-M6x13	-	AAY-07	-	-	AAL-02-2.5
A16M PWLNR/L 06	●	●	16	14.8	150	11	≥20								
A20P PWLNR/L 06	●	●	20	18.3	170	13	≥25								
A25R PWLNR/L 06	●	●	25	23	200	17	≥32	WNM. 0604..	APL-01	ALV-02-M6x17	AAWN-SW317	AAY-01	-	-	AAL-02-2.5
A32S PWLNR/L 06	●	●	32	30	250	22	≥40								
A40T PWLNR/L 06C	●	○	40	37.5	300	27	≥50								
A25R PWLNR/L 08C	●	●	25	23	200	17	≥32	WNM. 0804..	APL-02	ALV-03-M8x19	AAWN-3-0001	AAY-02	ACK-05	4015-M4x11	AAL-03-3
A32S PWLNR/L 08C	●	●	32	30	250	22	≥40								
A40T PWLNR/L 08C	●	●	40	37.5	300	27	≥50								
A50U PWLNR/L 08C	●	●	50	47	350	35	≥63								

R: Sağ / Right / Rechts L: Sol / Left / Links

● Stokta / In Stock / Auf Lager ○ Stokta Yok / Non Stock Item / Kein Lagerartikel, Lieferzeit auf Anfrage

Sipariş Örneği/Ordering Example/Bestellbeispiel

1 ad./pcs./stück S20R PWLNR 06



**AKKO**

www.akkco.com.tr



*konusulan  
the spoken kalite...  
quality...*

# S-SİSTEM

S-SİSTEM DELİK TORNA KATERLERİ  
S-SYSTEM BORING BARS  
S-SYSTEM BOHRSTANGE



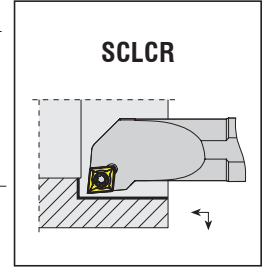
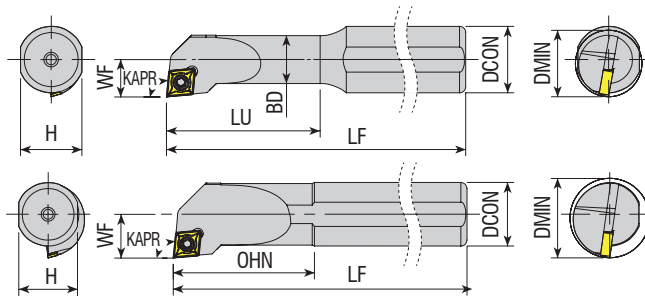

**Takım Kodu**  
**Ordering Code**  
**Bestell-Bezeichnung**

Stok Stock Lager	Takım Ölçüleri (mm) Dimension (mm) Abmessung (mm)								Kesici Uç Insert Wendeschneidplatte	Yedek Parçaları / Spare Parts / Ersatzteile				
	R	L	DCON	BD	H	LU=OHN	LF	WF		DMIN	Sıkma Vidası Screw Klemmschraube	Altlık Shim Unterlage	Altlık Vidası Shim Screw Schraube für Unterlage	Tork Anahtar Torx Key Torx Imensechskantschlüssel
	●	○	08	5	7.3	18	100	3	≥6	CC.T 030102	4006-M1.6x3.2			82-T06
S0508H SCLCR/L 03											4008-M2.5x4.5			
S0608H SCLCR/L 06	●	●	08	6	7.3	25	100	4.5	≥8					
S08H SCLCR/L 06	●	●	08	8	7.3	20	100	06	≥11	CC.T 0602..	4008-M2.5x6	-	-	82-T08
S10K SCLCR/L 06	●	●	10	10	09	25	125	07	≥13					
S12K SCLCR/L 06	●	●	12	12	11	25	125	09	≥16					
S1216P SCLCR/L 06	●	●	16	11.5	14.8	37	170	09	≥16	CC.T 09T3..	4015-M3.5x8			80-T15
S16P SCLCR/L 06	●	●	16	16	14.8	35	170	11	≥20		4015-M3.5x9	-	-	
S12K SCLCR/L 09	●	●	12	12	11	30	125	09	≥16					
S1416P SCLCR/L 09	●	●	16	14	14.8	45	170	9.5	≥17	CC.T 1204..	4015-M3.5x12	AACN-2-0001	AAV-08-M3.5x8	80-T20
S16P SCLCR/L 09	●	●	16	16	14.8	35	170	11	≥20		4020-M4.5x12	AACN-2-0003	AAV-10-M4.5x8	
S1620R SCLCR/L 09	●	●	20	16	18.3	50	200	11	≥20		1020-M4.5x16			
S20R SCLCR/L 09	●	●	20	20	18.3	40	200	13	≥25	CC.T 0602..	4008-M2.5x6	-	-	82-T08
S25S SCLCR/L 09	●	●	25	25	23	50	250	17	≥32					
S32T SCLCR/L 09	●	●	32	32	30	60	300	22	≥40					
S25S SCLCR/L 12	●	●	25	25	23	50	250	17	≥32	CC.T 09T3..	4015-M3.5x9	-	-	80-T15
S32T SCLCR/L 12	●	●	32	32	30	60	300	22	≥40		4015-M3.5x12	AACN-2-0001	AAV-08-M3.5x8	
S40U SCLCR/L 12	●	●	40	40	37.5	70	350	27	≥50		4015-M3.5x12	AACN-2-0001	AAV-08-M3.5x8	
A08H SCLCR/L 06	●	●	08	8	7.3	20	100	06	≥11	CC.T 1204..	4020-M4.5x12	AACN-2-0003	AAV-10-M4.5x8	80-T20
A10H SCLCR/L 06	●	●	10	10	09	25	100	07	≥13					
A12H SCLCR/L 06	●	●	12	12	11	25	100	09	≥16					
A16M SCLCR/L 09	●	●	16	16	14.8	35	150	11	≥20	CC.T 09T3..	4015-M3.5x9	-	-	80-T15
A20P SCLCR/L 09	●	●	20	20	18.3	40	170	13	≥25		4015-M3.5x12	AACN-2-0001	AAV-08-M3.5x8	
A25R SCLCR/L 09	●	●	25	25	23	50	200	17	≥32		4015-M3.5x12	AACN-2-0001	AAV-08-M3.5x8	
A32S SCLCR/L 09	●	●	32	32	30	60	250	22	≥40	CC.T 1204..	4020-M4.5x12	AACN-2-0003	AAV-10-M4.5x8	80-T20
A25R SCLCR/L 12	●	●	25	25	23	50	200	17	≥32					

R: Sağ / Right / Rechts L: Sol / Left / Links

● Stokta / In Stock / Auf Lager ○ Stokta Yok / Non Stock Item / Kein Lagerartikel, Lieferzeit auf Anfrage

Sipariş Örneği/Ordering Example/Bestellbeispiel

1 ad./pcs./stück S0508H SCLCR 03



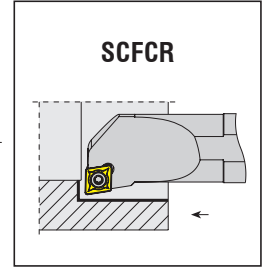
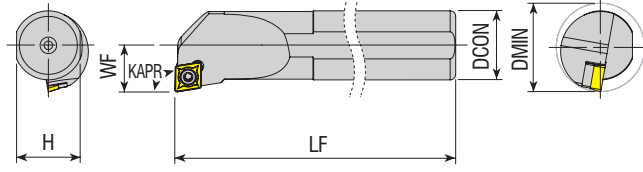

**Takım Kodu**  
**Ordering Code**  
*Bestell-Bezeichnung*

Stok Stock Lager	Takım Ölçüleri (mm) Dimension (mm) Abmessung (mm)						Kesici Uç Insert Wendeschneidplatte	Yedek Parçaları / Spare Parts / Ersatzteile				
	R	L	DCON	H	LF	WF		DMIN	Sıkma Vidası Screw Klemmschraube	Altlık Shim Unterlage	Altlık Vidası Shim Screw Schraube für Unterlage	Tork Anahtar Torx Key Torx Innensechskantschlüssel
	●	●	08	7.3	100	06	≥11	CC.T 0602..	4008-M2.5x6	-	-	82-T08
S08H SCFCR/L 06	●	●	10	09	125	07	≥13		4015-M3.5x8			
S10K SCFCR/L 06	●	●	12	11	125	09	≥16		4015-M3.5x9	-	-	
S12K SCFCR/L 06	●	●	12	11	125	09	≥16	CC.T 09T3..	4015-M3.5x12	AACN-2-0001	AAV-08-M3.5x8	80-T15
S12K SCFCR/L 09	●	●	16	14.8	170	11	≥20					
S16P SCFCR/L 09	●	●	20	18.3	200	13	≥25					
S20R SCFCR/L 09	●	●	25	23	250	17	≥32	CC.T 1204..	4020-M4.5x12	AACN-2-0003	AAV-10-M4.5x8	80-T20
S25S SCFCR/L 09	●	●	25	23	250	17	≥32		1020-M4.5x16			
S25S SCFCR/L 12	○	○	32	30	300	22	≥40					
S32T SCFCR/L 12	○	○	40	37.5	350	27	≥50	CC.T 0602..	4008-M2.5x6	-	-	82-T08
S40U SCFCR/L 12	○	○	08	7.3	100	06	≥11					
A08H SCFCR/L 06	●	○										

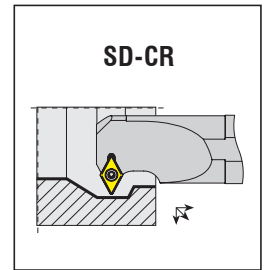
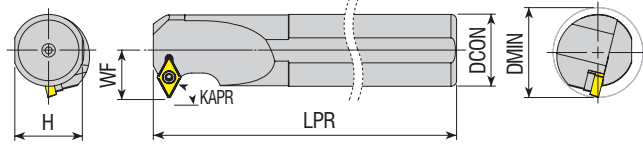

**Takım Kodu**  
**Ordering Code**  
*Bestell-Bezeichnung*

Stok Stock Lager	Takım Ölçüleri (mm) Dimension (mm) Abmessung (mm)						Kesici Uç Insert Wendeschneidplatte	Yedek Parçaları / Spare Parts / Ersatzteile				
	R	L	DCON	H	LPR	WF		DMIN	Sıkma Vidası Screw Klemmschraube	Altlık Shim Unterlage	Altlık Vidası Shim Screw Schraube für Unterlage	Tork Anahtar Torx Key Torx Innensechskantschlüssel
S10K SD-CR/L 07	●	●	10	9	125	07	≥14	DC.T 0702..	4008-M2.5x6	-	-	82-T08
S12K SD-CR/L 07	●	●	12	11	125	09	≥16					
S16P SD-CR/L 07	●	●	16	14.8	170	11	≥20					
S20R SD-CR/L 07	●	○	20	18.3	200	13	≥25	DC.T 11T3..	4015-M3.5x11	-	-	80-T15
S16P SD-CR/L 11	●	●	16	14.8	170	14	≥22		4015-M3.5x14	AADN-2-0001	AAV-06-M3.5x11	
S20R SD-CR/L 11	●	●	20	18.3	200	15	≥25					
S25S SD-CR/L 11	●	●	25	23	250	18	≥32					
S32T SD-CR/L 11	●	●	32	30	300	22	≥40					
S40U SD-CR/L 11	●	●	40	37.5	350	27	≥50					

R: Sağ / Right / Rechts L: Sol / Left / Links  
● Stokta / In Stock / Auf Lager ○ Stokta Yok / Non Stock Item / Kein Lagerartikel, Lieferzeit auf Anfrage

Sipariş Örneği/Ordering Example/Bestellbeispiel  
1 ad./pcs./stück S08H SCFCR 06

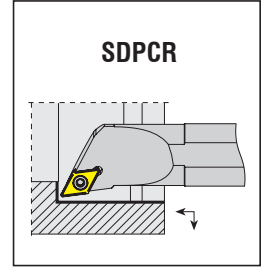
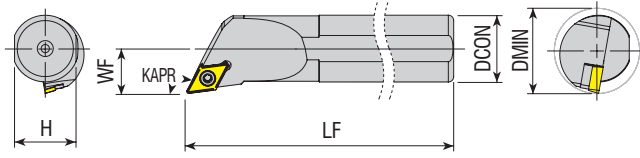

**Takım Kodu**  
**Ordering Code**  
*Bestell-Bezeichnung*

Stok Stock Lager	Takım Ölçüleri (mm) Dimension (mm) Abmessung (mm)						Kesici Uç Insert Wendeschneidplatte	Yedek Parçaları / Spare Parts / Ersatzteile				
	R	L	DCON	H	LF	WF		DMIN	Sıkma Vidası Screw Klemmschraube	Altlık Shim Unterlage	Altlık Vidası Shim Screw Schraube für Unterlage	Tork Anahtar Torx Key Torx Innensechskantschlüssel
S10K SDPCR/L 07	●	●	10	09	125	07	≥13	DC.T 0702..	4008-M2.5x6	-	-	82-T08
S12K SDPCR/L 07	●	●	12	11	125	09	≥16					
S16P SDPCR/L 11	●	●	16	14.8	170	11	≥20	DC.T 11T3..	4015-M3.5x9	-	-	80-T15
S20R SDPCR/L 11	●	●	20	18.3	200	13	≥25		4015-M3.5x11			
S25S SDPCR/L 11	●	●	25	23	250	17	≥32		4015-M3.5x12			

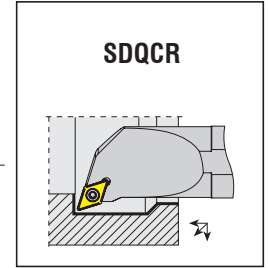
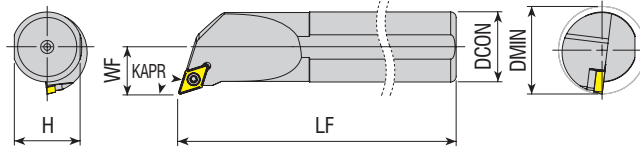

**Takım Kodu**  
**Ordering Code**  
*Bestell-Bezeichnung*

Stok Stock Lager	Takım Ölçüleri (mm) Dimension (mm) Abmessung (mm)						Kesici Uç Insert Wendeschneidplatte	Yedek Parçaları / Spare Parts / Ersatzteile				
	R	L	DCON	H	LF	WF		DMIN	Sıkma Vidası Screw Klemmschraube	Altlık Shim Unterlage	Altlık Vidası Shim Screw Schraube für Unterlage	Tork Anahtar Torx Key Torx Innensechskantschlüssel
S10K SDQCR/L 07	●	●	10	09	125	07	≥13	DC.T 0702..	4008-M2.5x6	-	-	82-T08
S12K SDQCR/L 07	●	●	12	11	125	09	≥16					
S16P SDQCR/L 07	●	●	16	14.8	170	11	≥20	DC.T 11T3..	4015-M3.5x9	-	-	80-T15
S20R SDQCR/L 07	●	●	20	18.3	200	13	≥25		4015-M3.5x11			
S16P SDQCR/L 11	●	●	16	14.8	170	11	≥20		4015-M3.5x12			
S20R SDQCR/L 11	●	●	20	18.3	200	13	≥25	4015-M3.5x14	-	-	80-T15	
S25S SDQCR/L 11	●	●	25	23	250	17	≥32					AAV-06-M3.5x11
S32T SDQCR/L 11	●	●	32	30	300	22	≥40	DC.T 0702..	4008-M2.5x6	-	-	82-T08
S40U SDQCR/L 11	●	●	40	37.5	350	27	≥50					
A10H SDQCR/L 07	●	●	10	09	100	07	≥13	DC.T 11T3..	4015-M3.5x9	-	-	80-T15
A12H SDQCR/L 07	●	●	12	11	100	09	≥16					
A16M SDQCR/L 07	●	●	16	14.8	150	11	≥20	4015-M3.5x12	-	-	80-T15	
A20P SDQCR/L 07	●	●	20	18.3	170	13	≥25					
A16M SDQCR/L 11	●	●	16	14.8	150	11	≥20	4015-M3.5x14	-	-	80-T15	
A20P SDQCR/L 11	●	●	20	18.3	170	13	≥25					AADN-2-0001
A25R SDQCR/L 11	●	●	25	23	200	17	≥32	-	-	-	80-T15	
A32S SDQCR/L 11	●	●	32	30	250	22	≥40					AAV-06-M3.5x11

R: Sağ / Right / Rechts L: Sol / Left / Links

● Stokta / In Stock / Auf Lager ○ Stokta Yok / Non Stock Item / Kein Lagerartikel, Lieferzeit auf Anfrage

Sipariş Örneği/Ordering Example/Bestellbeispiel

1 ad./pcs./stück S10K SDPCR 07

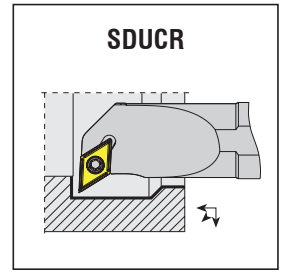
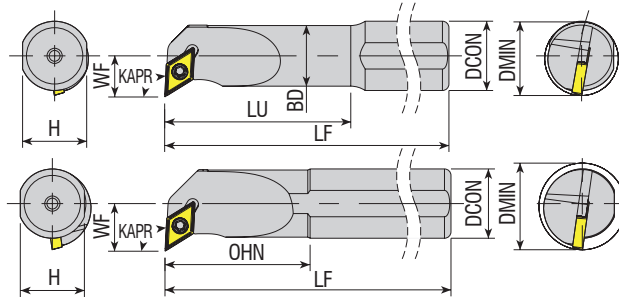

**Takım Kodu**  
**Ordering Code**  
**Bestell-Bezeichnung**

Takım Kodu Ordering Code Bestell-Bezeichnung	Stok Stock Lager		Takım Ölçüleri (mm) Dimension (mm) Abmessung (mm)							Kesici Uç Insert Wendeschneidplatte	Yedek Parçaları / Spare Parts / Ersatzteile				
	R	L	DCON	BD	H	LU=OHN	LF	WF	DMIN		Sıkma Vidası Screw Klemmschraube	Altlık Shim Unterlage	Altlık Vidası Shim Screw Schraube für Unterlage	Tork Anahtar Torx Key Torx Innensechskantschlüssel	
S0810K SDUCR/L 07	●	●	10	8	09	30	125	08	≥13	DC.T 0702..	4008-M2.5x6	-	-	82-T08	
S10K SDUCR/L 07	●	●	10	10	09	25	125	08	≥13						
S12K SDUCR/L 07	●	●	12	12	11	25	125	09	≥16						
S1216P SDUCR/L 07	●	●	16	11.5	14.8	37	170	09	≥16						
S1416P SDUCR/L 07	●	●	16	14	14.8	45	170	9.5	≥17						
S16P SDUCR/L 07	●	●	16	16	14.8	35	170	11	≥20						
S20R SDUCR/L 07	●	●	20	20	18.3	40	200	13	≥25	DC.T 11T3..	4015-M3.5x9	-	-	80-T15	
S1416P SDUCR/L 11	●	●	16	14	14.8	45	170	11	≥18						
S16P SDUCR/L 11	●	●	16	16	14.8	35	170	11	≥20						
S1620R SDUCR/L 11	●	●	20	16	18.3	50	200	11	≥20						
S20R SDUCR/L 11	●	●	20	20	18.3	40	200	13	≥25						
S25S SDUCR/L 11	●	●	25	25	23	50	250	17	≥32						
<b>new</b> S25T SDUCR/L 11	●	●	25	25	23	50	300	17	≥32						
S32T SDUCR/L 11	●	●	32	32	30	60	300	22	≥40						
S40U SDUCR/L 11	●	●	40	40	37.5	70	350	27	≥50						
S50V SDUCR/L 11	●	●	50	50	47	80	400	35	≥63						
A0810H SDUCR/L 07	●	●	10	8	09	30	100	08	≥13	DC.T 0702..	4008-M2.5x6	-	-	82-T08	
A10H SDUCR/L 07	●	●	10	10	09	25	100	08	≥13						
A12H SDUCR/L 07	●	●	12	12	11	25	100	09	≥16						
A16M SDUCR/L 07	●	●	16	16	14.8	35	150	11	≥20						
A20P SDUCR/L 07	●	●	20	20	18.3	40	170	13	≥25						
A16M SDUCR/L 11	●	●	16	16	14.8	35	150	11	≥20						
A20P SDUCR/L 11	●	●	20	20	18.3	40	170	13	≥25	DC.T 11T3..	4015-M3.5x12	AADN-2-0001	AAV-08-M3.5x8	80-T15	
A25R SDUCR/L 11	●	●	25	25	23	50	200	17	≥32						
<b>new</b> A25T SDUCR/L 11	●	○	25	25	23	50	300	17	≥32						
A32S SDUCR/L 11	●	●	32	32	30	60	250	22	≥40						
<b>new</b> A50U SDUCR/L 11	●	○	50	50	47	80	350	35	≥63						

R: Sağ / Right / Rechts L: Sol / Left / Links

● Stokta / In Stock / Auf Lager ○ Stokta Yok / Non Stock Item / Kein Lagerartikel, Lieferzeit auf Anfrage

Sipariş Örneği/Ordering Example/Bestellbeispiel  
1 ad./pcs./stück S0810K SDUCR 07

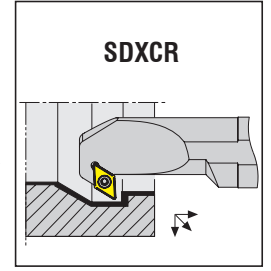
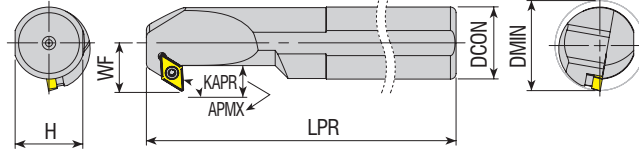

Takım Kodu Ordering Code Bestell-Bezeichnung	Stok Stock Lager	Takım Ölçüleri (mm) Dimension (mm) Abmessung (mm)						Kesici Uç Insert Wendeschneidplatte	Yedek Parçaları / Spare Parts / Ersatzteile				
		R	L	DCON	H	LPR	WF		APMX	DMIN	Sıkma Vidası Screw Klemmschraube	Altık Shim Unterlage	Altık Vidası Shim Screw Schraube für Unterlage
S12K SDXCR/L 07	●	●	12	11	125	09	4.5	≥16	DC.T 0702..	4008-M2.5x6	-	-	82-T08
S16P SDXCR/L 07	●	●	16	14.8	170	11	6.5	≥20		4015-M3.5x9	-	-	
S20R SDXCR/L 07	●	●	20	18.3	200	13	6.5	≥25	DC.T 11T3..	4015-M3.5x14	AADN-2-0001	AAV-08-M3.5x8	80-T15
S16P SDXCR/L 11	●	●	16	14.8	170	11	6.5	≥20				AAV-06-M3.5x11	
S20R SDXCR/L 11	●	●	20	18.3	200	14	7.5	≥25		AAV-08-M3.5x8			
S25S SDXCR/L 11	●	●	25	23	250	17	9	≥32		AAV-06-M3.5x11			
S32T SDXCR/L 11	●	●	32	30	300	22	12.5	≥40	DC.T 11T3..	4015-M3.5x14	AADN-2-0001	AAV-08-M3.5x8	80-T15
S40U SDXCR/L 11	●	●	40	37.5	350	27	14.5	≥50				AAV-06-M3.5x11	
A12H SDXCR/L 07	●	●	12	11	100	09	4.5	≥16	DC.T 0702..	4008-M2.5x6	-	-	82-T08
A16M SDXCR/L 07	●	●	16	14.8	150	11	6.5	≥20					
A20P SDXCR/L 07	●	●	20	18.3	170	13	6.5	≥25	DC.T 11T3..	4015-M3.5x11	-	-	80-T15
A16M SDXCR/L 11	●	●	16	14.8	150	11	7.5	≥20					
A20P SDXCR/L 11	●	●	20	18.3	170	14	7.5	≥25					
A25R SDXCR/L 11	●	●	25	23	200	17	9	≥32					
A32S SDXCR/L 11	●	●	32	30	250	22	12.5	≥40	4015-M3.5x14	AADN-2-0001	AAV-08-M3.5x8	AAV-06-M3.5x11	

R: Sağ / Right / Rechts L: Sol / Left / Links  
● Stokta / In Stock / Auf Lager ○ Stokta Yok / Non Stock Item / Kein Lagerartikel, Lieferzeit auf Anfrage  
Not: "APMX" ölçüleri R0.4'e göre verilmiştir.  
Note: Dimensions of "APMX" are given according to R0.4  
Hinweis: Das Maß "APMX" bezieht sich auf R 0,4

Sipariş Örneği/Ordering Example/Bestellbeispiel  
1 ad./pcs./stück S12K SDXCR 07

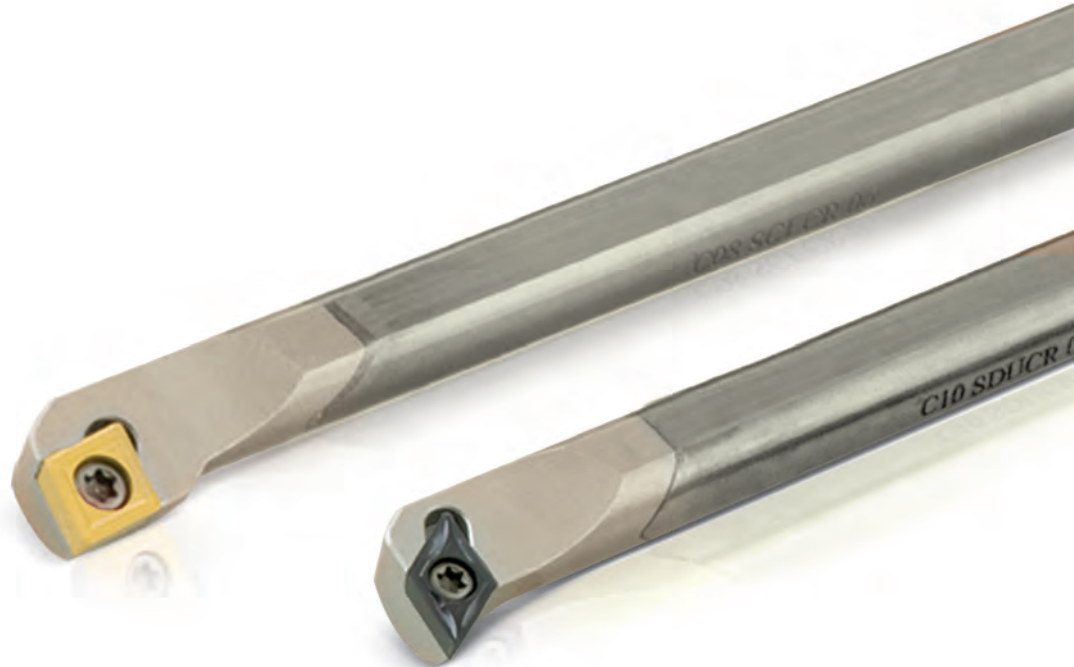

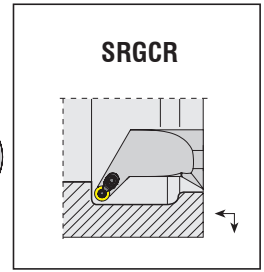
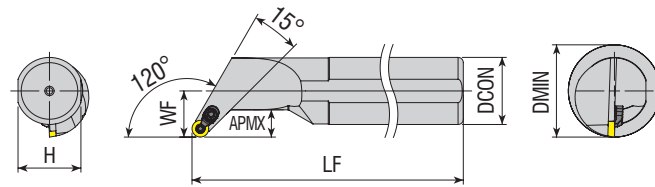

**Takım Kodu**  
**Ordering Code**  
*Bestell-Bezeichnung*

Stok Stock Lager	Takım Ölçüleri (mm) Dimension (mm) Abmessung (mm)							Kesici Uç Insert Wendeschneidplatte	Yedek Parçaları / Spare Parts / Ersatzteile						
	R	L	DCON	H	LF	WF	APMX		DMIN	Sıkma Vidası Screw Klemmschraube	Altık Shim Unterlage	Altık Vidası Shim Screw Schraube für Unterlage	Baskı Pabucu Shim Screw Spann Prütze	Pabuç Vidası Shim Screw Klemmschraube	Anahtar Allen Key Innensechskantschlüssel
	●	○	16	14.8	170	11	7	≥22	RCM. 0803..	3008-M3x8	-	-	ACK-15	4015-M3.5x11	82-T08
<b>S16P SRGCR/L 08</b>	●	○	16	14.8	170	11	7	≥22							
<b>S20R SRGCR/L 08</b>	●	●	20	18.3	200	13	7	≥26							
<b>S25S SRGCR/L 08C</b>	●	●	25	23	250	17	9.5	≥34							
<b>S32T SRGCR/L 08C</b>	●	○	32	30	300	22	13	≥44							
<b>S40U SRGCR/L 08C</b>	●	○	40	37.5	350	27	15	≥54							
<b>A16M SRGCR/L 08</b>	●	●	16	14.8	150	11	7	≥22							
<b>A20P SRGCR/L 08</b>	●	●	20	18.3	170	13	7	≥26							
<b>A25R SRGCR/L 08C</b>	●	●	25	23	200	17	9.5	≥34							
<b>A32S SRGCR/L 08C</b>	●	●	32	30	250	22	13	≥44							
<b>A40T SRGCR/L 08C</b>	●	●	40	37.5	300	27	15	≥54							



KAPR=45°

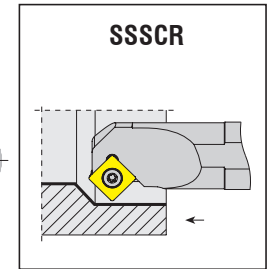
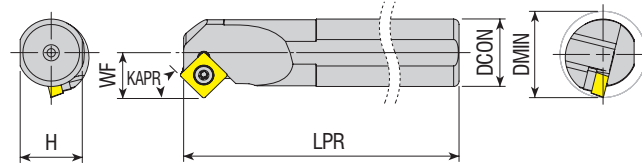

**Takım Kodu**  
**Ordering Code**  
*Bestell-Bezeichnung*

Stok Stock Lager	Takım Ölçüleri (mm) Dimension (mm) Abmessung (mm)						Kesici Uç Insert Wendeschneidplatte	Yedek Parçaları / Spare Parts / Ersatzteile				
	R	L	DCON	H	LPR	WF		DMIN	Sıkma Vidası Screw Klemmschraube	Altık Shim Unterlage	Altık Vidası Shim Screw Schraube für Unterlage	Tork Anahtar Torx Key Torx Innensechskantschlüssel
	●	●	16	14.8	170	11	≥20	SC.T 09T3..	4015-M3.5x9	-	-	80-T15
<b>S16P SSSCR/L 09</b>	●	●	16	14.8	170	11	≥20					
<b>S20R SSSCR/L 09</b>	●	●	20	18.3	200	13	≥25					
<b>S25S SSSCR/L 09</b>	●	●	25	23	250	17	≥32	SC.T 1204..	4015-M3.5x11	AASN-2-0001	AAV-08-M3.5x8	80-T15
<b>S25S SSSCR/L 12</b>	●	●	25	23	250	17	≥32					
<b>S32T SSSCR/L 12</b>	●	○	32	30	300	22	≥40					
<b>S40U SSSCR/L 12</b>	●	○	40	37.5	350	27	≥50					

R: Sağ / Right / Rechts L: Sol / Left / Links

● Stokta / In Stock / Auf Lager ○ Stokta Yok / Non Stock Item / Kein Lagerartikel, Lieferzeit auf Anfrage

Sipariş Örneği/Ordering Example/Bestellbeispiel

1 ad./pcs./stück S16P SRGCR 08

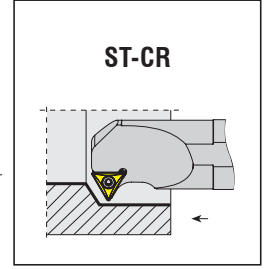
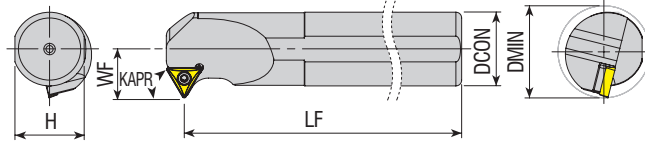

ST-CR

Takım Kodu Ordering Code Bestell-Bezeichnung	Stok Stock Lager		Takım Ölçüleri (mm) Dimension (mm) Abmessung (mm)					Kesici Uç Insert Wendeschneidplatte	Yedek Parçaları / Spare Parts / Ersatzteile			
	R	L	DCON	H	LF	WF	DMIN		Sıkma Vidası Screw Klemmschraube	Altlık Shim Unterlage	Altlık Vidası Shim Screw Schraube für Unterlage	Tork Anahtar Torx Key Torx Innensechskantschlüssel
S12K ST-CR/L 11	●	●	12	11	125	09	≥17	TC.T 1102..	4008-M2.5x6	-	-	82-T08
S16P ST-CR/L 11	●	○	16	14.8	170	11	≥20					
S20R ST-CR/L 11	●	○	20	18.3	200	13	≥25					
S16P ST-CR/L 16	●	●	16	14.8	170	11	≥20	TC.T 16T3..	4015-M3.5x9 4015-M3.5x11	-	-	80-T15
S20R ST-CR/L 16	●	●	20	18.3	200	13	≥25					
S25S ST-CR/L 16	●	●	25	23	250	17	≥32					
S32T ST-CR/L 16	●	●	32	30	300	22	≥40	4015-M3.5x14	AATN-2-0001	AAV-08-M3.5x8 AAV-06-M3.5x11	80-T15	
S40U ST-CR/L 16	●	●	40	37.5	350	27	≥50					

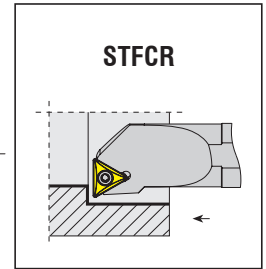
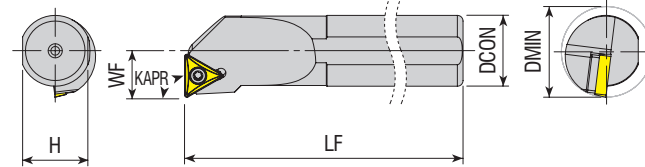

STFCR

Takım Kodu Ordering Code Bestell-Bezeichnung	Stok Stock Lager		Takım Ölçüleri (mm) Dimension (mm) Abmessung (mm)					Kesici Uç Insert Wendeschneidplatte	Yedek Parçaları / Spare Parts / Ersatzteile			
	R	L	DCON	H	LF	WF	DMIN		Sıkma Vidası Screw Klemmschraube	Altlık Shim Unterlage	Altlık Vidası Shim Screw Schraube für Unterlage	Tork Anahtar Torx Key Torx Innensechskantschlüssel
S0610F STFCR/L 06	●	●	10	09	80	4.5	≥08	TC.T 06T1..	3006-M2x4	-	-	82-T06
S08H STFCR/L 06	●	●	08	7.3	100	06	≥11					
S10K STFCR/L 09	●	●	10	09	125	07	≥13	TC.T 0902..	3007-M2.2x4.6	-	-	82-T07
S12K STFCR/L 09	●	●	12	11	125	09	≥17					
S12K STFCR/L 11	●	●	12	11	125	09	≥17	TC.T 1102..	4008-M2.5x6	-	-	82-T08
S16P STFCR/L 11	●	●	16	14.8	170	11	≥20					
S20R STFCR/L 11	●	●	20	18.3	200	13	≥25					
S16P STFCR/L 16	●	●	16	14.8	170	11	≥20	TC.T 16T3..	4015-M3.5x9 4015-M3.5x11	-	-	80-T15
S20R STFCR/L 16	●	●	20	18.3	200	13	≥25					
S25S STFCR/L 16	●	●	25	23	250	17	≥32					
S32T STFCR/L 16	●	●	32	30	300	22	≥40	4015-M3.5x14	AATN-2-0001	AAV-08-M3.5x8 AAV-06-M3.5x11	80-T15	
S40U STFCR/L 16	●	○	40	37.5	350	27	≥50					
A10H STFCR/L 11	●	●	10	09	100	07	≥13	TC.T 1102..	4008-M2.5x6	-	-	82-T08
A12H STFCR/L 11	●	●	12	11	100	09	≥17					
A16M STFCR/L 11	●	●	16	14.8	150	11	≥20					

R: Sağ / Right / Rechts L: Sol / Left / Links

● Stokta / In Stock / Auf Lager ○ Stokta Yok / Non Stock Item / Kein Lagerartikel, Lieferzeit auf Anfrage

Sipariş Örneği/Ordering Example/Bestellbeispiel

1 ad./pcs./stück S12K ST-CR 11

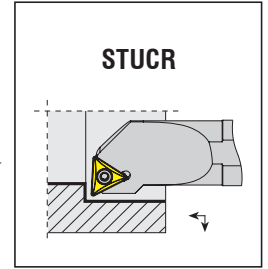
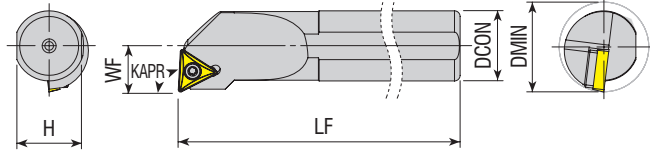

**Takım Kodu**  
**Ordering Code**  
**Bestell-Bezeichnung**

Stok  
Stock  
Lager

Takım Ölçüleri (mm)  
Dimension (mm)  
Abmessung (mm)

Kesici Uç  
Insert  
Wendeschneidplatte

Yedek Parçaları / Spare Parts / Ersatzteile

Sıkma Vidası  
Screw  
Klemmschraube

Altlık  
Shim  
Unterlage

Altlık Vidası  
Shim Screw  
Schraube für Unterlage

Tork Anahtar  
Torx Key  
Torx Innensechskantschlüssel

Takım Kodu Ordering Code Bestell-Bezeichnung	Stok Stock Lager		Takım Ölçüleri (mm) Dimension (mm) Abmessung (mm)				Kesici Uç Insert Wendeschneidplatte	Sıkma Vidası Screw Klemmschraube	Altlık Shim Unterlage	Altlık Vidası Shim Screw Schraube für Unterlage	Tork Anahtar Torx Key Torx Innensechskantschlüssel
	R	L	DCON	H	LF	WF					
S10K STUCR/L 09	●	●	10	09	125	07	≥13	TC.T 0902..	3007-M2.2x4.6		82-T07
S12K STUCR/L 09	●	●	12	11	125	09	≥16				
S12K STUCR/L 11	●	●	12	11	125	09	≥17	TC.T 1102..	4008-M2.5x6	-	82-T08
S16P STUCR/L 11	●	●	16	14.8	170	11	≥20				
S20R STUCR/L 11	●	●	20	18.3	200	13	≥25	TC.T 16T3..	4015-M3.5x9 4015-M3.5x11	-	80-T15
S16P STUCR/L 16	●	●	16	14.8	170	11	≥20				
S20R STUCR/L 16	●	●	20	18.3	200	13	≥25	4015-M3.5x14	AATN-2-0001	AAV-08-M3.5x8 AAV-06-M3.5x11	80-T15
S25S STUCR/L 16	●	●	25	23	250	17	≥32				
S32T STUCR/L 16	●	●	32	30	300	22	≥40	TC.T 0902..	3007-M2.2x4.6		82-T07
S40U STUCR/L 16	●	●	40	37.5	350	27	≥50				
A10H STUCR/L 09	●	●	10	09	100	07	≥13	TC.T 1102..	4008-M2.5x6	-	82-T08
A12H STUCR/L 09	●	●	12	11	100	09	≥16				
A12H STUCR/L 11	●	●	12	11	100	09	≥16	4015-M3.5x9 4015-M3.5x11	-	-	80-T15
A16M STUCR/L 11	●	●	16	14.8	150	11	≥20				
A20P STUCR/L 11	●	●	20	18.3	170	13	≥25	4015-M3.5x14	AATN-2-0001	AAV-08-M3.5x8 AAV-06-M3.5x11	80-T15
A16M STUCR/L 16	●	●	16	14.8	150	11	≥20				
A20P STUCR/L 16	●	●	20	18.3	170	13	≥25	TC.T 16T3..	4015-M3.5x14	AATN-2-0001	80-T15
A25R STUCR/L 16	●	●	25	23	200	17	≥32				
A32S STUCR/L 16	●	●	32	30	250	22	≥40				

R: Sağ / Right / Rechts L: Sol / Left / Links

● Stokta / In Stock / Auf Lager ○ Stokta Yok / Non Stock Item / Kein Lagerartikel, Lieferzeit auf Anfrage

Sipariş Örneği/Ordering Example/Bestellbeispiel

1 ad./pcs./stück S10K STUCR 09



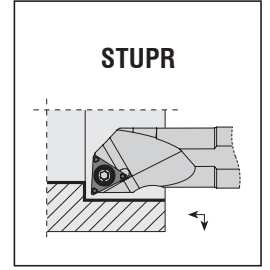
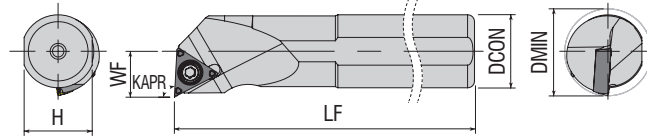

Takım Kodu Ordering Code Bestell-Bezeichnung	Stok Stock Lager		Takım Ölçüleri (mm) Dimension (mm) Abmessung (mm)				Kesici Uç Insert Wendeschneidplatte	Yedek Parçaları / Spare Parts / Ersatzteile					
	R	L	DCON	H	LF	WF		DMIN	Sıkma Vidası Screw Klemmschraube	Altık Shim Unterlage	Altık Vidası Shim Screw Schraube für Unterlage	Tork Anahtar Torx Key Torx Innensechskantschlüssel	
S08H STUPR/L 0802	●	○	08	7.3	100	05	≥10	TP. 0802..	3006-M2x4			82-T06	
S10K STUPR/L 1103	●	○	10	09	125	06	≥12		TP. 1103..	4010-M3x6			
S12K STUPR/L 1103	●	○	12	11	125	08	≥16	4010-M3x8					
S12M STUPR/L 1103	●	○	12	11	150	08	≥16						
S16P STUPR/L 1103	●	○	16	14.8	170	10	≥20						
S16R STUPR/L 1103	●	○	16	14.8	200	10	≥20						
A20R STUPR/L 1103	●	○	20	18.3	200	13	≥25						

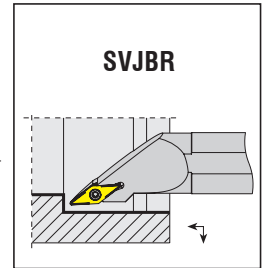
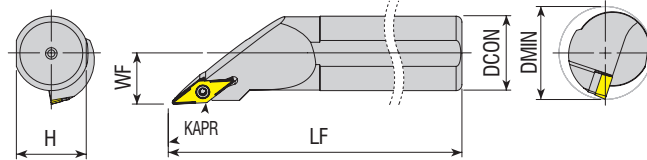

Takım Kodu Ordering Code Bestell-Bezeichnung	Stok Stock Lager		Takım Ölçüleri (mm) Dimension (mm) Abmessung (mm)				Kesici Uç Insert Wendeschneidplatte	Yedek Parçaları / Spare Parts / Ersatzteile					
	R	L	DCON	H	LF	WF		DMIN	Sıkma Vidası Screw Klemmschraube	Altık Shim Unterlage	Altık Vidası Shim Screw Schraube für Unterlage	Tork Anahtar Torx Key Torx Innensechskantschlüssel	
S25S SVJBR/L 16	●	●	25	23	250	17	≥32	VB.T 1604..	4015-M3.5x12	AAVN-2-0002	AAV-08-M3.5x8	80-T15	
S32T SVJBR/L 16	●	●	32	30	300	22	≥40		4015-M3.5x14		AAV-06-M3.5x11		
S40U SVJBR/L 16	●	●	40	37.5	350	27	≥50						

R: Sağ / Right / Rechts L: Sol / Left / Links  
● Stokta / In Stock / Auf Lager ○ Stokta Yok / Non Stock Item / Kein Lagerartikel, Lieferzeit auf Anfrage

Sipariş Örneği/Ordering Example/Bestellbeispiel  
1 ad./pcs./stück S08H STUPR 0802



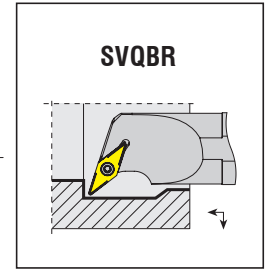
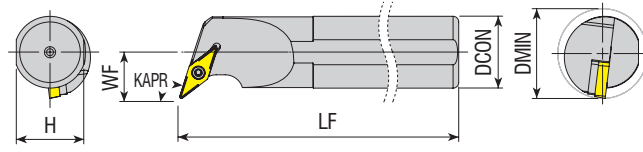

Takım Kodu Ordering Code Bestell-Bezeichnung	Stok Stock Lager		Takım Ölçüleri (mm) Dimension (mm) Abmessung (mm)					Kesici Uç Insert Wendeschneidplatte	Sıkma Vidası Screw Klemmschraube	Altık Shim Unterlage	Altık Vidası Shim Screw Schraube für Unterlage	Tork Anahtar Torx Key Torx Innensechskantschlüssel
	R	L	DCON	H	LF	WF	DMIN					
S16P SVQBR/L 11	●	●	16	14.8	170	11	≥20	VB.T 1103..	4008-M2.5x6	-	-	82-T08
S20R SVQBR/L 11	●	●	20	18.3	200	13	≥25					
S25S SVQBR/L 16	●	●	25	23	250	17	≥32	VB.T 1604..	4015-M3.5x14	AAVN-2-0002	AAV-08-M3.5x8	80-T15
S32T SVQBR/L 16	●	●	32	30	300	22	≥40				AAV-06-M3.5x11	
S40U SVQBR/L 16	●	●	40	37.5	350	27	≥50	VB.T 1103..	4008-M2.5x6	-	-	82-T08
A20Q SVQBR/L 11	●	●	20	18.5	180	13	≥25					
A20Q SVQBR/L 16	●	●	20	18.5	180	20	≥30	VB.T 1604..	4015-M3.5x11	-	-	80-T15
A25S SVQBR/L 16	●	●	25	23	250	17	≥32					
A32S SVQBR/L 16	●	●	32	30	250	22	≥40		4015-M3.5x14	AAVN-2-0002	AAV-06-M3.5x11	

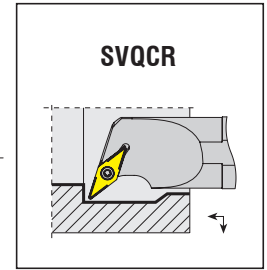
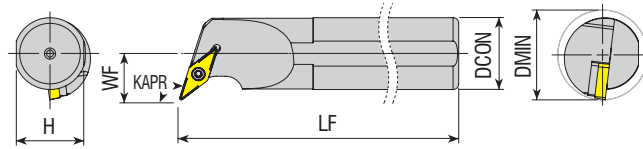

Takım Kodu Ordering Code Bestell-Bezeichnung	Stok Stock Lager		Takım Ölçüleri (mm) Dimension (mm) Abmessung (mm)					Kesici Uç Insert Wendeschneidplatte	Sıkma Vidası Screw Klemmschraube	Altık Shim Unterlage	Altık Vidası Shim Screw Schraube für Unterlage	Tork Anahtar Torx Key Torx Innensechskantschlüssel
	R	L	DCON	H	LF	WF	DMIN					
S16P SVQCR/L 11	●	●	16	14.8	170	11	≥20	VC.T 1103..	4008-M2.5x6	-	-	82-T08
S20R SVQCR/L 11	●	●	20	18.3	200	13	≥25					
S25S SVQCR/L 16	●	●	25	23	250	17	≥32	VC.T 1604..	4015-M3.5x14	AAVN-2-0002	AAV-08-M3.5x8	80-T15
S32T SVQCR/L 16	●	●	32	30	300	22	≥40				AAV-06-M3.5x11	
S40U SVQCR/L 16	●	●	40	37.5	350	27	≥50	VC.T 1103..	4008-M2.5x6	-	-	82-T08
A16M SVQCR/L 11	●	●	16	14.8	150	11	≥20					
A20P SVQCR/L 11	●	●	20	18.3	170	13	≥25	VC.T 1604..	4015-M3.5x14	AAVN-2-0002	AAV-08-M3.5x8	80-T15
A25R SVQCR/L 16	●	●	25	23	200	17	≥32				AAV-06-M3.5x11	
A32S SVQCR/L 16	●	●	32	30	250	22	≥40					
A40T SVQCR/L 16	●	●	40	37.5	300	27	≥50					

R: Sağ / Right / Rechts L: Sol / Left / Links

● Stokta / In Stock / Auf Lager ○ Stokta Yok / Non Stock Item / Kein Lagerartikel, Lieferzeit auf Anfrage

Sipariş Örneği/Ordering Example/Bestellbeispiel  
1 ad./pcs./stück S16P SVQBR 11

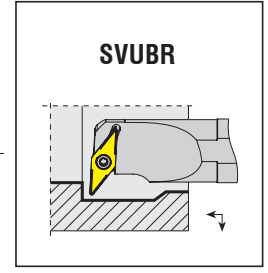
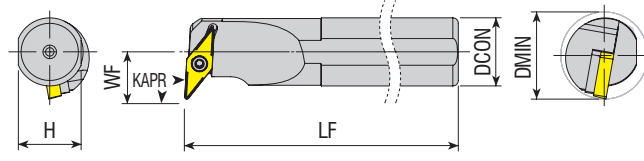

Takım Kodu Ordering Code Bestell-Bezeichnung	Stok Stock Lager		Takım Ölçüleri (mm) Dimension (mm) Abmessung (mm)					Kesici Uç Insert Wendeschneidplatte	Yedek Parçaları / Spare Parts / Ersatzteile			
	R	L	DCON	H	LF	WF	DMIN		Sıkma Vidası Screw Klemmschraube	Altık Shim Unterlage	Altık Vidası Shim Screw Schraube für Unterlage	Tork Anahtar Torx Key Torx Innensechskantschlüssel
S16P SVUBR/L 11	●	●	16	14.8	170	12.5	≥20	VB.T 1103..	4008-M2.5x6	-	-	82-T08
S20R SVUBR/L 11	●	●	20	18.3	200	13	≥25					
S25S SVUBR/L 16	●	●	25	23	250	19	≥32	VB.T 1604..	4015-M3.5x14	AAVN-2-0002	AAV-06-M3.5x11	80-T15
S32T SVUBR/L 16	●	●	32	30	300	22	≥40					
S40U SVUBR/L 16	●	●	40	37.5	350	27	≥50					
A20Q SVUBR/L 16	●	○	20	18.3	180	20	≥30					
A32S SVUBR/L 16	●	●	32	30	250	22	≥40	4015-M3.5x14	AAVN-2-0002	AAV-06-M3.5x11		

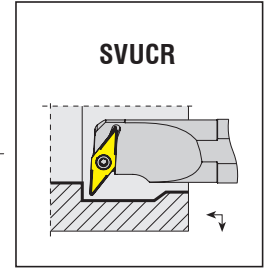
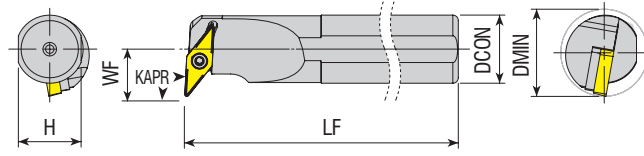

Takım Kodu Ordering Code Bestell-Bezeichnung	Stok Stock Lager		Takım Ölçüleri (mm) Dimension (mm) Abmessung (mm)					Kesici Uç Insert Wendeschneidplatte	Yedek Parçaları / Spare Parts / Ersatzteile			
	R	L	DCON	H	LF	WF	DMIN		Sıkma Vidası Screw Klemmschraube	Altık Shim Unterlage	Altık Vidası Shim Screw Schraube für Unterlage	Tork Anahtar Torx Key Torx Innensechskantschlüssel
S16P SVUCR/L 11	●	●	16	14.8	170	12.5	≥20	VC.T 1103..	4008-M2.5x6	-	-	82-T08
S20R SVUCR/L 11	●	●	20	18.3	200	13	≥25					
S25S SVUCR/L 16	●	●	25	23	250	19	≥32	VC.T 1604..	4015-M3.5x14	AAVN-2-0002	AAV-06-M3.5x11	80-T15
S32T SVUCR/L 16	●	●	32	30	300	22	≥40					
S40U SVUCR/L 16	●	●	40	37.5	350	27	≥50					
A12K SVUCR/L 07	●	●	12	11	125	9	≥16					
A20P SVUCR/L 11	●	○	20	18.3	170	13	≥25	VC.T 1103..	4008-M2.5x6	-	-	82-T08
A20Q SVUCR/L 11	●	●	20	18.3	180	13	≥25	VC.T 1103..	4008-M2.5x6	-	-	82-T08
A25R SVUCR/L 16	●	●	25	23	200	19	≥32	VC.T 1604..	4015-M3.5x14	AAVN-2-0002	AAV-06-M3.5x11	80-T15

R: Sağ / Right / Rechts L: Sol / Left / Links  
● Stokta / In Stock / Auf Lager ○ Stokta Yok / Non Stock Item / Kein Lagerartikel, Lieferzeit auf Anfrage

Sipariş Örneği/Ordering Example/Bestellbeispiel  
1 ad./pcs./stück S16P SVUBR 11

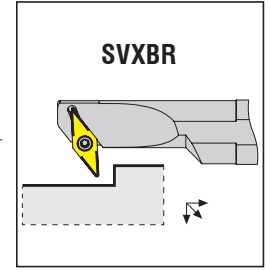
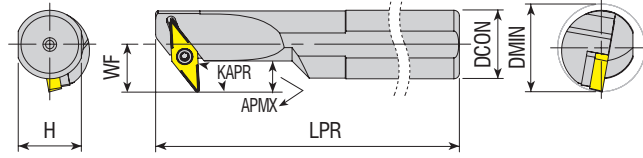

Takım Kodu Ordering Code Bestell-Bezeichnung	Stok Stock Lager		Takım Ölçüleri (mm) Dimension (mm) Abmessung (mm)					Kesici Uç Insert Wendeschneidplatte	Yedek Parçaları / Spare Parts / Ersatzteile				
	R	L	DCON	H	LPR	WF	APMX		DMIN	Sıkma Vidası Screw Klemmschraube	Altlık Shim Unterlage	Altlık Vidası Shim Screw Schraube für Unterlage	Tork Anahtar Torx Key Torx Innensechskantschlüssel
<b>S16P SVXBR/L 1102</b>	●	○	16	14.8	170	12.5	7.2	≥20	VBM. 1102..	4008-M2.5x6	-	-	82-T08
<b>S20R SVXBR/L 1102</b>	●	●	20	18.3	200	13	5.7	≥25					
<b>S16P SVXBR/L 11</b>	●	●	16	14.8	170	12.5	7.2	≥20	VB.T 1103..				
<b>S20R SVXBR/L 11</b>	●	●	20	18.3	200	13	5.7	≥25					
<b>S25S SVXBR/L 16</b>	●	●	25	23	250	19	10.2	≥32	VB.T 1604..	4015-M3.5x14	AAVN-2-0002	AAV-06-M3.5x11	80-T15
<b>S32T SVXBR/L 16</b>	●	●	32	30	300	22	11.7	≥40					
<b>S40U SVXBR/L 16</b>	●	●	40	37.5	350	27	14.3	≥50					

Not: "APMX" ölçüleri R0.4'e göre verilmiştir.  
Note: Dimensions of "APMX" are given according to R0,4  
Hinweis: Das Maß "APMX" bezieht sich auf R 0,4

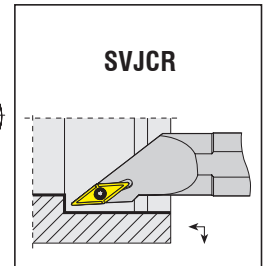
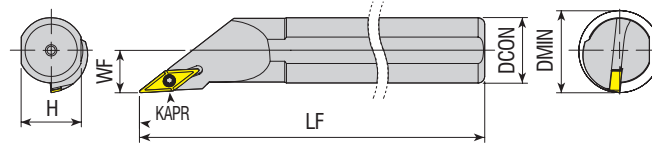

Takım Kodu Ordering Code Bestell-Bezeichnung	Stok Stock Lager		Takım Ölçüleri (mm) Dimension (mm) Abmessung (mm)					Kesici Uç Insert Wendeschneidplatte	Yedek Parçaları / Spare Parts / Ersatzteile			
	R	L	DCON	H	LF	WF	DMIN		Sıkma Vidası Screw Klemmschraube	Altlık Shim Unterlage	Altlık Vidası Shim Screw Schraube für Unterlage	Tork Anahtar Torx Key Torx Innensechskantschlüssel
<b>S12K SVJCR/L 11</b>	●	●	12	11	125	7	≥13	VC.T 1103..	4008-M2.5x6	-	-	82-T08
<b>S16P SVJCR/L 11</b>	●	●	16	14.8	170	11	≥20					
<b>S20R SVJCR/L 11</b>	●	●	20	18.3	200	13	≥25					
<b>A12H SVJCR/L 11</b>	●	●	12	11	100	07	≥13					
<b>A16M SVJCR/L 11</b>	●	●	16	14.8	150	11	≥20					
<b>A20P SVJCR/L 11</b>	●	●	20	18.3	170	13	≥25					

R: Sağ / Right / Rechts L: Sol / Left / Links  
● Stokta / In Stock / Auf Lager ○ Stokta Yok / Non Stock Item / Kein Lagerartikel, Lieferzeit auf Anfrage

Sipariş Örneği/Ordering Example/Bestellbeispiel  
1 ad./pcs./stück S16P SVXBR 1102

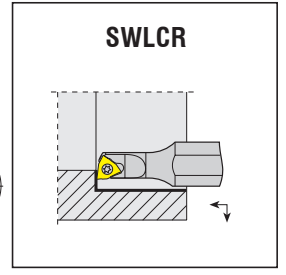
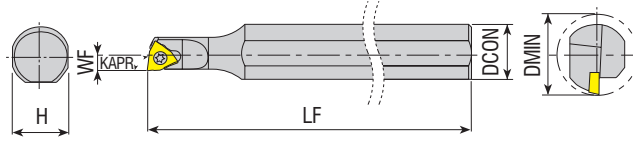

Takım Kodu Ordering Code Bestell-Bezeichnung	Stok Stock Lager	Takım Ölçüleri (mm) Dimension (mm) Abmessung (mm)						Kesici Uç Insert Wendeschneidplatte	Yedek Parçaları / Spare Parts / Ersatzteile			
		DCON	H	LF	WF	DMIN	Sıkma Vidası Screw Klemmschraube		Altık Shim Unterlage	Altık Vidası Shim Screw Schraube für Unterlage	Tork Anahtar Torx Key Torx Innensechskantschlüssel	
S0608H SWLCR/L 03	●	08	7.3	100	04	≥08	WC.. 0302..					
S0810K SWLCR/L 03	●	10	09	125	06	≥10						

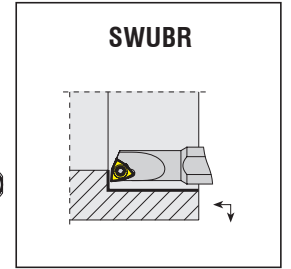
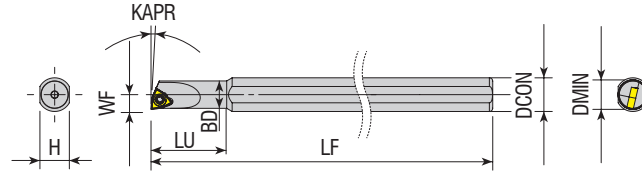

Takım Kodu Ordering Code Bestell-Bezeichnung	Stok Stock Lager	Takım Ölçüleri (mm) Dimension (mm) Abmessung (mm)								Kesici Uç Insert Wendeschneidplatte	Yedek Parçaları / Spare Parts / Ersatzteile							
		DCON	BD	H	LU	LF	DMIN	WF	Sıkma Vidası Screw Klemmschraube		Altık Shim Unterlage	Altık Vidası Shim Screw Schraube für Unterlage	Tork Anahtar Torx Key Torx Innensechskantschlüssel					
S0610H SWUBR 06	●	10	5	7.3	18	100	≥6	3	WBGT 060102-L									
S08H SWUBR 06-5.5	●	08	5	7.3	18	100	≥5.7	2.75							3006-M2x3.3	-	-	82-T06
new S08H SWUBL 06-5.5	●	08	5	7.3	18	100	≥5.7	2.75							3006-M2x4			
S08H SWUBR 06-7	●	08	6.5	7.3	18	100	≥7	3.5										

R: Sağ / Right / Rechts L: Sol / Left / Links

● Stokta / In Stock / Auf Lager ○ Stokta Yok / Non Stock Item / Kein Lagerartikel, Lieferzeit auf Anfrage

KYCR-ISCR Ucuna Uygunudur. / Compatible with KYCR-ISCR Insert. / Kompatibel mit KYCR-ISCR Wendeplatten.

Sipariş Örneği/Ordering Example/Bestellbeispiel

1 ad./pcs./stück S0608H SWLCR 03

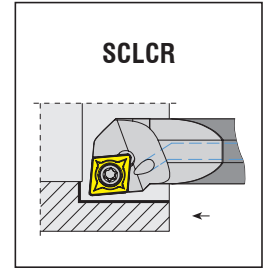
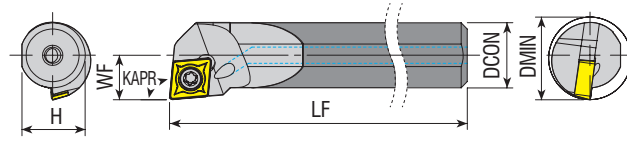

Takım Kodu Ordering Code Bestell-Bezeichnung	Stok Stock Lager		Takım Ölçüleri (mm) Dimension (mm) Abmessung (mm)				Kesici Uç Insert Wendeschneidplatte	Yedek Parçaları / Spare Parts / Ersatzteile				
	R	L	DCON	H	LF	WF		DMIN	Sıkma Vidası Screw Klemmschraube	Altlık Shim Unterlage	Altlık Vidası Shim Screw Schraube für Unterlage	Tork Anahtar Torx Key Torx Innensechskantschlüssel
	●	○										
<b>new</b> C04G SCLCR/L 03	●	○	4	3.7	90	2.5	≥5	CC. 0301..	4006-M1.6x3.2			82-T06
<b>new</b> C05H SCLCR/L 03	●	○	5	4.7	100	3	≥6					
<b>new</b> C06J SCLCR/L 04	●	○	6	5.7	110	3.5	≥7	CC. 0401..	3006-M2x3.3			82-T08
<b>new</b> C07K SCLCR/L 04	●	○	7	6.7	125	4	≥8					
C06J SCLCR/L 06	●	○	6	5.7	110	4.5	≥8	CC.T 0602..	4008-M2.5x4.5	-	-	82-T08
E08K SCLCR/L 06	●	●	8	7.5	125	6	≥11					
E10M SCLCR/L 06	●	●	10	9.5	150	7	≥13					
E12Q SCLCR/L 06	●	●	12	11	180	9	≥16	CC.T 09T3..	4015-M3.5x9			80-T15
E16R SCLCR/L 09	●	●	16	15	200	11	≥20					
E20S SCLCR/L 09	●	●	20	19	250	13	≥24					

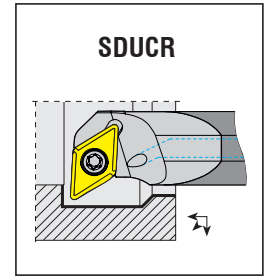
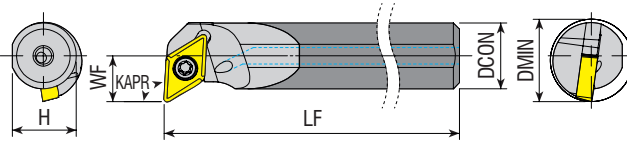

Takım Kodu Ordering Code Bestell-Bezeichnung	Stok Stock Lager		Takım Ölçüleri (mm) Dimension (mm) Abmessung (mm)				Kesici Uç Insert Wendeschneidplatte	Yedek Parçaları / Spare Parts / Ersatzteile				
	R	L	DCON	H	LF	WF		DMIN	Sıkma Vidası Screw Klemmschraube	Altlık Shim Unterlage	Altlık Vidası Shim Screw Schraube für Unterlage	Tork Anahtar Torx Key Torx Innensechskantschlüssel
	●	○										
E10M SDUCR/L 07	●	●	10	9.5	150	8	≥13	DC.T 0702..	4008-M2.5x6	-	-	82-T08
E12Q SDUCR/L 07	●	●	12	11	180	9	≥16					
E16R SDUCR/L 11	●	●	16	15	200	11	≥20	DC.T 11T3..	4015-M3.5x9	-	-	80-T15
E20S SDUCR/L 11	●	●	20	18.3	250	12	≥23					

R: Sağ / Right / Rechts L: Sol / Left / Links

● Stokta / In Stock / Auf Lager ○ Stokta Yok / Non Stock Item / Kein Lagerartikel, Lieferzeit auf Anfrage

Sipariş Örneği/Ordering Example/Bestellbeispiel  
1 ad./pcs./stück C04G SCLCR 03

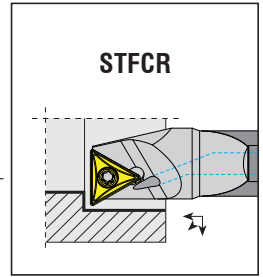
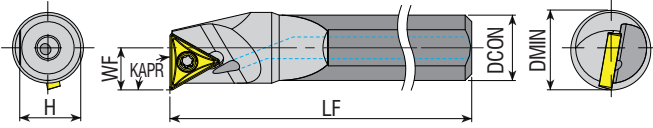

Takım Kodu Ordering Code Bestell-Bezeichnung	Stok Stock Lager		Takım Ölçüleri (mm) Dimension (mm) Abmessung (mm)				Kesici Uç Insert Wendeschneidplatte	Yedek Parçaları / Spare Parts / Ersatzteile				
	R	L	DCON	H	LF	WF		DMIN	Sıkma Vidası Screw Klemmschraube	Altık Shim Unterlage	Altık Vidası Shim Screw Schraube für Unterlage	Tork Anahtar Torx Key Torx Innensechskantschlüssel
E10M STFRCR/L 09	●	●	10	9.5	150	6	12					
E12Q STFRCR/L 09	●	●	12	11	180	8	15	TC.T 0902..	3007-M2.2x5	-	-	82-T07
E12Q STFRCR/L 11	●	●	12	11	180	8	15					

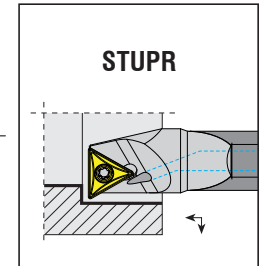
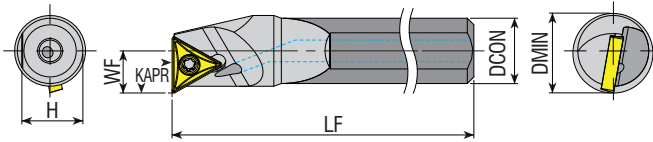

Takım Kodu Ordering Code Bestell-Bezeichnung	Stok Stock Lager		Takım Ölçüleri (mm) Dimension (mm) Abmessung (mm)				Kesici Uç Insert Wendeschneidplatte	Yedek Parçaları / Spare Parts / Ersatzteile				
	R	L	DCON	H	LF	WF		DMIN	Sıkma Vidası Screw Klemmschraube	Altık Shim Unterlage	Altık Vidası Shim Screw Schraube für Unterlage	Tork Anahtar Torx Key Torx Innensechskantschlüssel
E12Q STUPR/L 1103	●	○	12	11	180	8	15	TP. 1103..	4010-M3x6	-	-	82-T10
E16R STUPR/L 1103	●	○	16	15	200	11	20					

R: Sağ / Right / Rechts L: Sol / Left / Links

● Stokta / In Stock / Auf Lager ○ Stokta Yok / Non Stock Item / Kein Lagerartikel, Lieferzeit auf Anfrage

Sipariş Örneği/Ordering Example/Bestellbeispiel

1 ad./pcs./stück E10M STFRCR 09

SET-A/SCLCR/L

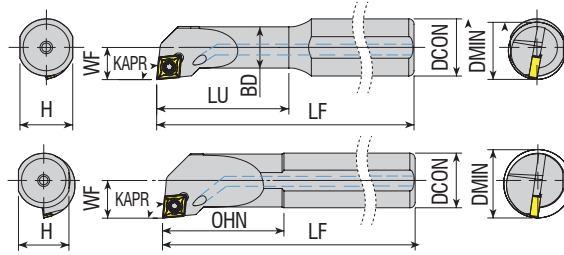

SCLCR

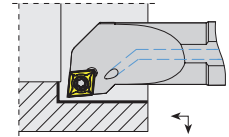

Takım Kodu  
Ordering Code  
Bestell-Bezeichnung

A08H SCLCR/L 06  
A10H SCLCR/L 06  
A12H SCLCR/L 06  
A16M SCLCR/L 09

Stok Stock Lager	Takım Ölçüleri (mm) Dimension (mm) Abmessung (mm)									Kesici Uç Insert Wendeschneidplatte	Yedek Parçaları / Spare Parts / Ersatzteile			
	R	L	DCON	BD	H	LU=OHN	LF	WF	DMIN		Sıkma Vidası Screw Klemmschraube	Altlık Shim Unterlage	Altlık Vidası Shim Screw Schraube für Unterlage	Tork Anahtar Torx Key Torx Innensechskantschlüssel
	●●		8	8	7.3	20	100	6	≥11	CC.T 0602..	4008-M2.5x6	-	-	82-T08
	●●		10	10	9	25	100	7	≥13					
	●●		12	12	11	25	100	9	≥16					
	●●		16	16	14.8	35	150	11	≥20					

SET-E/SCLCR/L

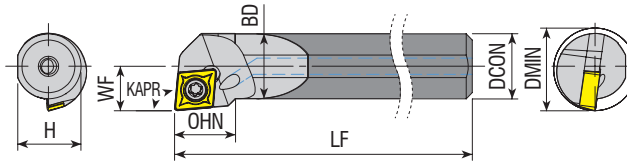

SCLCR

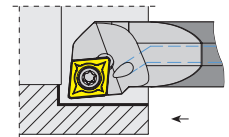

Takım Kodu  
Ordering Code  
Bestell-Bezeichnung

E08K SCLCR/L 06  
E10M SCLCR/L 06  
E12Q SCLCR/L 06  
E16R SCLCR/L 09

Stok Stock Lager	Takım Ölçüleri (mm) Dimension (mm) Abmessung (mm)									Kesici Uç Insert Wendeschneidplatte	Yedek Parçaları / Spare Parts / Ersatzteile			
	R	L	DCON	BD	H	OHN	LF	WF	DMIN		Sıkma Vidası Screw Klemmschraube	Altlık Shim Unterlage	Altlık Vidası Shim Screw Schraube für Unterlage	Tork Anahtar Torx Key Torx Innensechskantschlüssel
	●○		8	8	7.5	10	125	6	≥11	CC.T 0602..	4008-M2.5x6	-	-	82-T08
	●○		10	10	9.5	10	150	7	≥13					
	●○		12	12	11	12	180	9	≥16					
	●○		16	16	15	15	200	11	≥20					

SET-S/SCLCR/L

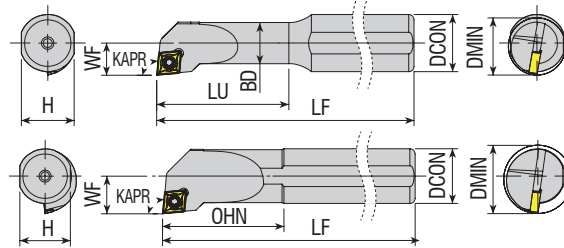

SCLCR

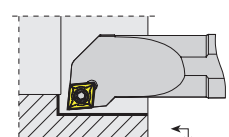

Takım Kodu  
Ordering Code  
Bestell-Bezeichnung

S08H SCLCR/L 06  
S10K SCLCR/L 06  
S12K SCLCR/L 06  
S16P SCLCR/L 09

Stok Stock Lager	Takım Ölçüleri (mm) Dimension (mm) Abmessung (mm)									Kesici Uç Insert Wendeschneidplatte	Yedek Parçaları / Spare Parts / Ersatzteile			
	R	L	DCON	BD	H	LU=OHN	LF	WF	DMIN		Sıkma Vidası Screw Klemmschraube	Altlık Shim Unterlage	Altlık Vidası Shim Screw Schraube für Unterlage	Tork Anahtar Torx Key Torx Innensechskantschlüssel
	●●		8	8	7.3	20	100	6	≥11	CC.T 0602..	4008-M2.5x6	-	-	82-T08
	●●		10	10	9	25	125	7	≥13					
	●●		12	12	11	25	125	9	≥16					
	●●		16	16	14.8	35	170	11	≥20					

R: Sağ / Right / Rechts L: Sol / Left / Links

● Stokta / In Stock / Auf Lager ○ Stokta Yok / Non Stock Item / Kein Lagerartikel, Lieferzeit auf Anfrage

Sipariş Örneği/Ordering Example/Bestellbeispiel

1 ad./pcs./stück SET-A/SCLCR

SET-A/SDUCR/L

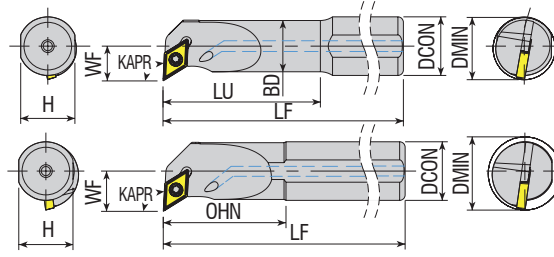

SDUCR

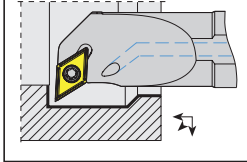

**Takım Kodu**  
**Ordering Code**  
*Bestell-Bezeichnung*

Stok  
Stock  
Lager

Takım Ölçüleri (mm)  
Dimension (mm)  
Abmessung (mm)

Kesici Uç  
Insert  
Wendeschneidplatte

Yedek Parçaları / Spare Parts / Ersatzteile

Sıkma Vidası  
Screw  
Klemmschraube

Altlık  
Shim  
Unterlage

Altlık Vidası  
Shim Screw  
Schraube für Unterlage

Tork Anahtar  
Torx Key  
Torx-Immersechskantschlüssel

R L DCON BD H LU=OHN LF WF DMIN

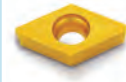

**A10H SDUCR/L 07**  
**A12H SDUCR/L 07**  
**A16M SDUCR/L 11**

● ● 10 10 09 25 100 08 ≥13  
● ● 12 12 11 25 100 09 ≥16  
● ● 16 16 14.8 35 150 11 ≥20

**DC.T 0702..**  
**DC.T 11T3..**

4008-M2.5x6  
4015-M3.5x9

-  
-

-  
-

82-T08  
80-T15

SET-E/SDUCR/L

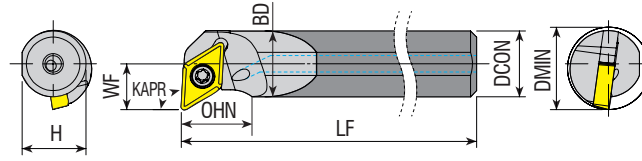

SDUCR

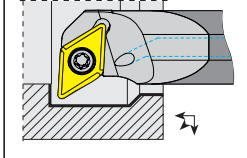

**Takım Kodu**  
**Ordering Code**  
*Bestell-Bezeichnung*

Stok  
Stock  
Lager

Takım Ölçüleri (mm)  
Dimension (mm)  
Abmessung (mm)

Kesici Uç  
Insert  
Wendeschneidplatte

Yedek Parçaları / Spare Parts / Ersatzteile

Sıkma Vidası  
Screw  
Klemmschraube

Altlık  
Shim  
Unterlage

Altlık Vidası  
Shim Screw  
Schraube für Unterlage

Tork Anahtar  
Torx Key  
Torx-Immersechskantschlüssel

R L DCON BD H OHN LF WF DMIN

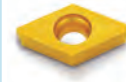

**E10M SDUCR/L 07**  
**E12Q SDUCR/L 07**  
**E16R SDUCR/L 11**

● ○ 10 10 9.5 09 150 8 ≥13  
● ○ 12 12 11 10 180 9 ≥16  
● ○ 16 16 15 12 200 11 ≥20

**DC.T 0702..**  
**DC.T 11T3..**

4008-M2.5x6  
4015-M3.5x9

-  
-

-  
-

82-T08  
80-T15

SET-S/SDUCR/L

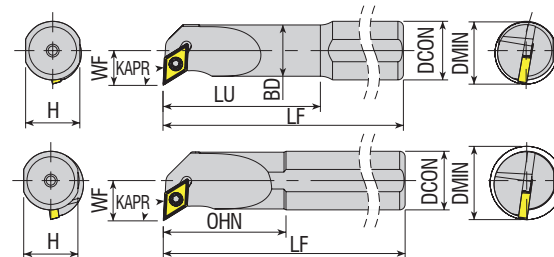

SDUCR

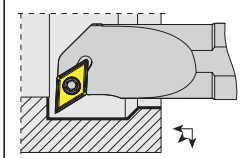

**Takım Kodu**  
**Ordering Code**  
*Bestell-Bezeichnung*

Stok  
Stock  
Lager

Takım Ölçüleri (mm)  
Dimension (mm)  
Abmessung (mm)

Kesici Uç  
Insert  
Wendeschneidplatte

Yedek Parçaları / Spare Parts / Ersatzteile

Sıkma Vidası  
Screw  
Klemmschraube

Altlık  
Shim  
Unterlage

Altlık Vidası  
Shim Screw  
Schraube für Unterlage

Tork Anahtar  
Torx Key  
Torx-Immersechskantschlüssel

R L DCON BD H LU=OHN LF WF DMIN

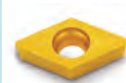

**S10K SDUCR/L 07**  
**S12K SDUCR/L 07**  
**S16P SDUCR/L 11**

● ● 10 10 9 25 125 8 ≥13  
● ● 12 12 11 25 125 9 ≥16  
● ● 16 16 14.8 35 170 11 ≥20

**DC.T 0702..**  
**DC.T 11T3..**

4008-M2.5x6  
4015-M3.5x9

-  
-

-  
-

82-T08  
80-T15





*konusulan*  
*the spoken kalite...*  
*quality...*

# TIRLAMAZ

**TIRLAMAZ TAKIMLAR**  
**ANTIVIBRATION TOOLS**  
**SCHWINGUNGSGEDÄMPFTE BOHRSTANGEN**



**AKKO** **A** **TT** **B** **D16** **204** **10D** **H** **E**

<b>2</b> Takım Tipi Tool Type Werkzeugtyp	<b>3</b> Gövde Body Schaft	<b>4</b> Bağlantı Çapı Connection Diameter Anschlussdurchmesser	<b>5</b> Takım Boyu Overall length Gesamtlänge	<b>6</b> Bağlama Boyu Overhang maximum Maximale Auskrugung	<b>7</b> İçten Soğutmalı With Coolant Hole Mit Innenkühlung
Tırlamaz Takım Anti Vibration Tool Schwingungsgedämpfte Bohrstanqe					
<b>8</b> Takım Malzemesi Type of Boring Bar Art der Bohrstanqe					
Karbür Takviyeli Carbide reinforced Hartmetall verstärkt					

**AKKO** **A** **TT** **C** **A** **16** **SDUCR11**

<b>2</b> Takım Tipi Tool Type Werkzeugtyp	<b>3</b> Kartuş Kodu Cartridge Code Bezeichnung für Wechselkopf	<b>4</b> İçten Soğutmalı With Coolant Hole Mit Innenkühlung	<b>5</b> Bağlama Çapı Connection Diameter Anschlussdurchmesser
Tırlamaz Takım Kartuşu Anti Vibration Tool Cartridge Wechselkopf für Schwingungsgedämpfte Bohrstanqe	Kartuş Cartridge Wechselkopf		Ø16 - Ø20 - Ø25 Ø32 - Ø40
<b>2</b> Kartuş Tipi Cartridge Type Wechselkopftyp			
SDUCR/L, SCLCR/L, SVUCR/L, TCLNR/L, TDUNR/L			

**AKKO** **A** **TT** **C** **16-25**

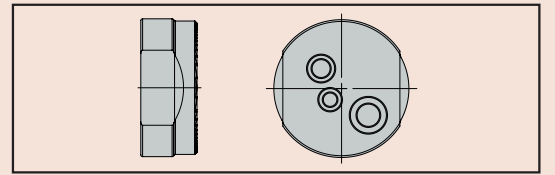

<b>2</b> Takım Tipi Tool Type Werkzeugtyp	<b>3</b> Kartuş Cartridge Wechselkopf	<b>4</b> Kullanılan Gövde Çap Aralığı Usable diameter range for body Nutzbarer Durchmesserbereich für Werkzeugschaft
Tırlamaz Takım Kartuşu Anti Vibration Tool Cartridge Wechselkopf für Schwingungsgedämpfte Bohrstanqen	Merkezeleme Kartuş Kodu Centering Cartridge Code Bezeichnung für zentriertes Wechselkopf	ATTB-D16/D20/D25 ATTB-D32/D40/D50/D60

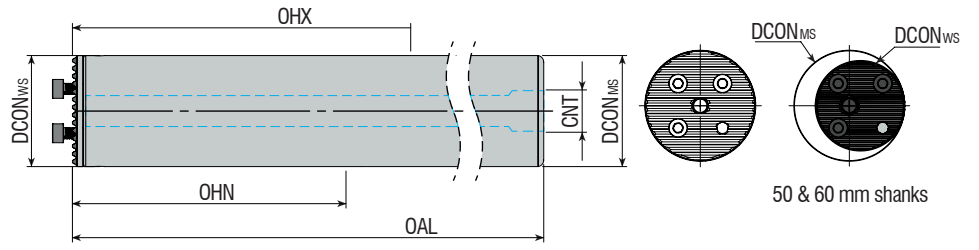

Takım Kodu Ordering Code Bestell-Bezeichnung	Stok Stock Lager	Takım Ölçüleri (mm) Dimension (mm) Abmessung (mm)							Yedek Parçaları / Spare Parts / Ersatzteile		
		DCONMS	DCONWS	OAL	OHN	OHX	CNT	Montaj Vidası Shim Screw Schraube für Unterlage		Montaj Vida Anahtar Mounting Screw Key Монтажный винт столовой под шестигранник	
								DCON	DMIN		
ATTB-D16-156-7D-H	○	16	16	156	55	92	G1/8	16	20	2525-M3X10	AAL-02-2.5
ATTB-D16-204-10D-H-E	○	16	16	204	96	140	G1/8	16	20		
ATTB-D20-200-7D-H	○	20	20	200	70	120	G1/4	20	25	2525-M3.5X10	AAL-03-3
ATTB-D20-260-10D-H-E	○	20	20	260	120	180	G1/4	20	25		
ATTB-D25-255-7D-H	●	25	25	255	88	158	G1/4	25	32	2503-M4X12	AAL-05-4
ATTB-D25-330-10D-H	○	25	25	330	155	230	G1/4	25	32		
ATTB-D32-320-7D-H	●	32	32	320	100	192	G3/8	32	40	2504-M5X16	AAL-07-5
ATTB-D32-416-10D-H	○	32	32	416	192	288	G3/8	32	40		
ATTB-D40-408-7D-H	●	40	40	408	128	248	G1/2	40	50	2505-M6X16	AAL-07-5
ATTB-D40-528-10D-H	○	40	40	528	248	368	G1/2	40	50		
ATTB-D50-519-7D-H	●	50	40	519	168	318	G1/2	40	63	2505-M6X16	AAL-07-5
ATTB-D50-669-10D-H	○	50	40	669	318	468	G1/2	40	63		
ATTB-D60-628-7D-H	●	60	40	628	208	388	G3/4	40	80	2505-M6X16	AAL-07-5
ATTB-D60-808-10D-H	○	60	40	808	388	568	G3/4	40	80		

R: Sağ / Right / Rechts L: Sol / Left / Links

● Stokta / In Stock / Auf Lager ○ Stokta Yok / Non Stock Item / Kein Lagerartikel, Lieferzeit auf Anfrage

Sipariş Örneği/Ordering Example/Bestellbeispiel  
1 ad./pcs./stück ATTB-D16-156-7D-H



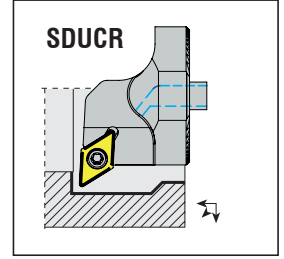
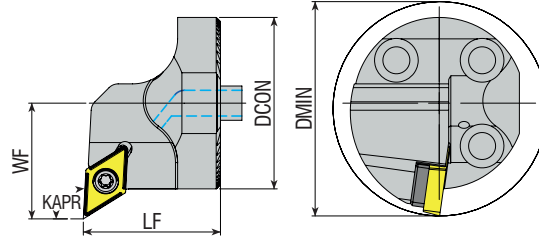

Takım Kodu Ordering Code Bestell-Bezeichnung	Stok Stock Lager		Takım Ölçüleri (mm) Dimension (mm) Abmessung (mm)				Kesici Uç Insert Wendeschneidplatte	Yedek Parçaları / Spare Parts / Ersatzteile			
	R	L	DCON	LF	WF	DMIN		Sıkma Vidası Screw Klemmschraube	Altlık Shim Unterlage	Altlık Vidası Shim Screw Schraube für Unterlage	Tork Anahtar Torx Key Torx Innensechskantschlüssel
ATTC-A16 SDUCR/L 07	●	●	16	20	11	20	DC.T 0702..	4008-M2.5x6	-	-	82-T08
ATTC-A20 SDUCR/L 11	●	●	20	20	13	25		4015-M3.5x11	-	-	
ATTC-A25 SDUCR/L 11	●	●	25	23	17	32	DC.T 11T3..	4015-M3.5x12	-	AAV-08-M3.5x8	80-T15
ATTC-A32 SDUCR/L 11	●	●	32	32	22	40		4015-M3.5x14	AADN-2-0001	AAV-06-M3.5x11	
ATTC-A40 SDUCR/L 11	●	●	40	32	27	50		-	-	-	

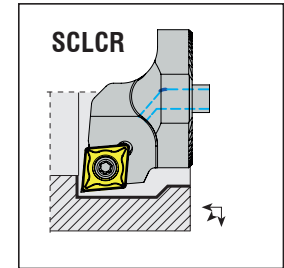
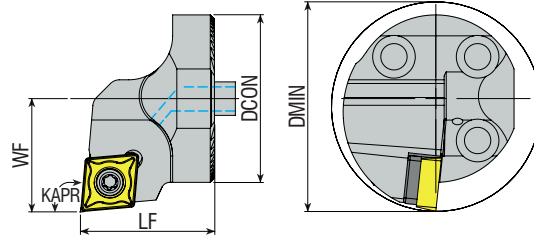

Takım Kodu Ordering Code Bestell-Bezeichnung	Stok Stock Lager		Takım Ölçüleri (mm) Dimension (mm) Abmessung (mm)				Kesici Uç Insert Wendeschneidplatte	Yedek Parçaları / Spare Parts / Ersatzteile			
	R	L	DCON	LF	WF	DMIN		Sıkma Vidası Screw Klemmschraube	Altlık Shim Unterlage	Altlık Vidası Shim Screw Schraube für Unterlage	Tork Anahtar Torx Key Torx Innensechskantschlüssel
ATTC-A16 SCLCR/L 06	●	●	16	20	11	20	CC.T 0602..	4008-M2.5x6	-	-	82-T08
ATTC-A20 SCLCR/L 09	●	●	20	20	13	25		4015-M3.5x9	-	-	
ATTC-A25 SCLCR/L 09	●	●	25	23	17	32	CC.T 09T3..	4015-M3.5x12	AACN-2-0001	AAV-08-M3.5x8	80-T15
ATTC-A32 SCLCR/L 09	●	●	32	32	22	40		4015-M3.5x14	AACN-2-0003	AAV-07-M4.5x13	
ATTC-A40 SCLCR/L 12	●	●	40	32	27	50	CC.T 1204..	1020-M4.5x16	AACN-2-0003	AAV-07-M4.5x13	80-T20

R: Sağ / Right / Rechts L: Sol / Left / Links  
● Stokta / In Stock / Auf Lager ○ Stokta Yok / Non Stock Item / Kein Lagerartikel, Lieferzeit auf Anfrage

Sipariş Örneği/Ordering Example/Bestellbeispiel  
1 ad./pcs./stück ATTC-A16-SDUCR 07

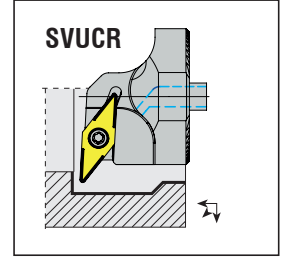
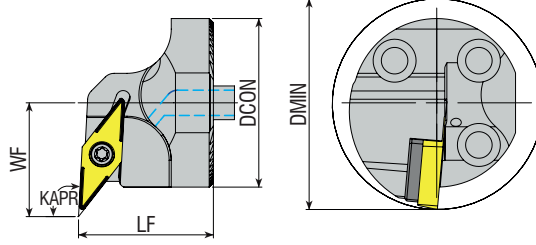

Takım Kodu Ordering Code Bestell-Bezeichnung	Stok Stock Lager		TAKIM ÖLÇÜLERİ (MM) DIMENSION (MM) ABMESSUNG (MM)				Kesici Uç Insert Wendeschneidplatte	Yedek Parçaları / Spare Parts / Ersatzteile				
	R	L	DCON	LF	WF	DMIN		Sıkma Vidası Screw Klemmschraube	Altık Shim Unterlage	Altık Vidası Shim Screw Schraube für Unterlage	Tork Anahtar Torx Key Innensechskantschlüssel	
ATTC-A20 SVUCR/L 11	●	●	20	20	15	27			-	-		
ATTC-A25 SVUCR/L 11	●	●	25	23	17	32	<b>VC.T 1103..</b>	4008-M2.5x6	-	-	82-T08	
ATTC-A32 SVUCR/L 16	●	●	32	32	22	40	<b>VC.T 1604..</b>	4015-M3.5x14	AAVN-2-0002	AAV-06-M3.5x11	80-T15	
ATTC-A40 SVUCR/L 16	●	●	40	32	27	50						

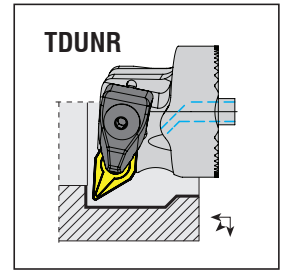
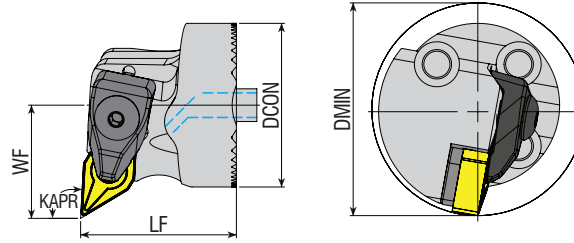

Takım Kodu Ordering Code Bestell-Bezeichnung	Stok Stock Lager		Takım Ölçüleri (mm) Dimension (mm) Abmessung (mm)				Kesici Uç Insert Wendeschneidplatte	Yedek Parçaları / Spare Parts / Ersatzteile						
	R	L	DCON	LF	WF	DMIN		Baskı Pabuçu Wedge Clamp Spannpratze	Pabuç Vidası Clamp Screw Klemmschraube	Altık Shim Unterlage	Altık Vidası Shim Screw Schraube für Unterlage	Segman Ring Feder	Pul Stamp Ring	Anahtar Allen Key Innensechskantschlüssel
ATTC-A32 TDUNR/L 11	●	●	32	32	22	40	<b>DNM. 1104..</b>	ATK-01	AKV-01-M5x22	AADN -2-0001	AAV-04-M5x12	AS-01	ABPL-01	AAL-03-3
ATTC-A40 TDUNR/L 15	●	●	40	38	27	50	<b>DNM. 1506..</b>	ATK-02	AKV-30-M6x22	AADN -3-0001	AAV-02-M5x12			

R: Sağ / Right / Rechts L: Sol / Left / Links

● Stokta / In Stock / Auf Lager ○ Stokta Yok / Non Stock Item / Kein Lagerartikel, Lieferzeit auf Anfrage

Sipariş Örneği/Ordering Example/Bestellbeispiel

1 AD./PCS./STÜCK ATTC-A20 SVUCR 11

**TIRLAMAZ TAKIMLARIN KARTUŞLARI**  
**ANTI VIBRATION TOOLS CARTRIDGES**  
 WECHSELKOPF FÜR SCHWINGUNGSGEDÄMPFTE BORSTANGE

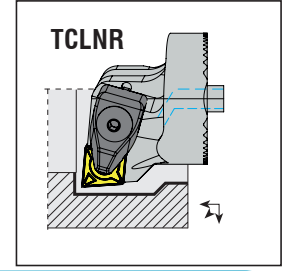
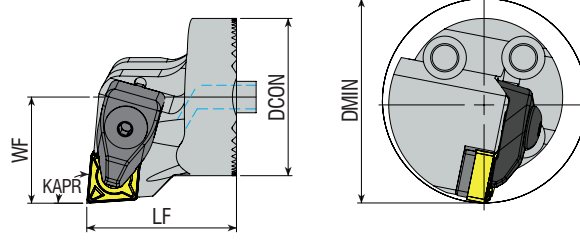

Takım Kodu Ordering Code Bestell-Bezeichnung	Stok Stock Lager		Takım Ölçüleri (mm) Dimension (mm) Abmessung (mm)				Kesici Uç Insert Wendeschneidplatte	Baskı Pabucu Wedge Clamp Spannpratze	Pabuç Vidası Clamp Screw Klemmschraube	Altlık Shim Unterlage	Altlık Vidası Shim Screw Schraube für Unterlage	Segman Ring Feder	Pul Stamp Ring	Anahtar Allen Key Innensechskantschlüssel
	R	L	DCON	LF	WF	DMIN								
ATTC-A32 TCLNR/L 12	●	●	32	32	22	40	<b>CNM. 1204..</b>	ATK-02	AKV-30-M6x22	AACN -3-0001	AAV-02-M5x12	AS-01	ABPL-01	AAL-03-3
ATTC-A40 TCLNR/L 12	●	●	40	38	27	50								

**TIRLAMAZ TAKIMLARIN MERKEZLEME APARATI**  
**ANTI VIBRATION TOOLS CENTERING INSTRUMENT**  
 ZENTRIERWERKZEUG FÜR SCHWINGUNGSGEDÄMPFTE BORSTANGE

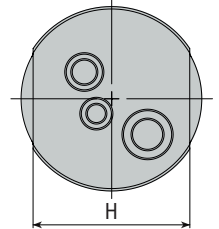
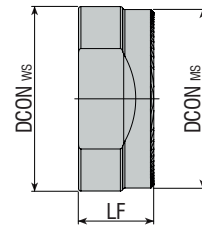

Takım Kodu Ordering Code Bestell-Bezeichnung	Stok Stock Lager	Takım Ölçüleri (mm) Dimension (mm) Abmessung (mm)				Gövde Tipi Boring Bars Борштанги
		DCONWS	DCONMS	LF	H	
ATTC-16-25	●	28	25	15	22	ATTB-D16/D20/D25
ATTC-32-60	●	53	40	20	35	ATTB-D32/D40/D50/D60

R: Sağ / Right / Rechts L: Sol / Left / Links  
 ● Stokta / In Stock / Auf Lager ○ Stokta Yok / Non Stock Item / Kein Lagerartikel, Lieferzeit auf Anfrage

Sipariş Örneği/Ordering Example/Bestellbeispiel  
 1 ad./pcs./stück ATTC-A32 TCLNR 12

## 1 Montaj ve Ayarlama | Assembly and Adjusting | Montage und Einstellung

Kartuş ve gövdenin montaj edilecek yüzeyleri, tutucunun iç kısmı temizlenmelidir. Aşağıdaki görselde A ve B konumlarına bakın.

The surface of the cartridge and the shank to be mounted, as well as the inner part of the toolholder should be cleaned. Check A and B in the image below.

Die Oberflächen des Wechselkopfes und des zu montierenden Schafts sowie der innere Teil des Werkzeughalters sollten gereinigt werden. Siehe A und B unten auf der Abbildung

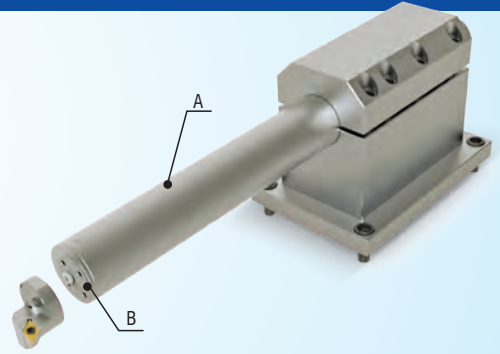

## 2 Gövde Montajı | Assembly for the Shank | Schaftmontage

Bağlama uzunluğu 4 L / D oranından az olmamalıdır. Tutucunun üst kısmını çıkartma yöntemiyle veya diğer tutma sıkma yöntemleriyle kullanmanızı öneririz (C tipi). Vidalı bağlama yöntemi kullanmayın. Uzun süre çalışırken lütfen içten soğutmayı kullanın.

The clamping length should not be less than 4 L/D ratio. Suggest using the clamping cover with opening method and other holding clamping methods. (Type C). Do not use screw clamping method. Use inner cooling please when working a long time.

Die Einspannlänge sollte nicht weniger als 4 L / D ratio betragen. Vorgeschlagen ist die Oberseite des Halters zu öffnen und andere Halte-Klemmethoden zu verwenden. (Typ C). Bitte nicht die Schraubklemmethode verwenden. Bei langer Nutzung, bitte die Innenkühlung verwenden.

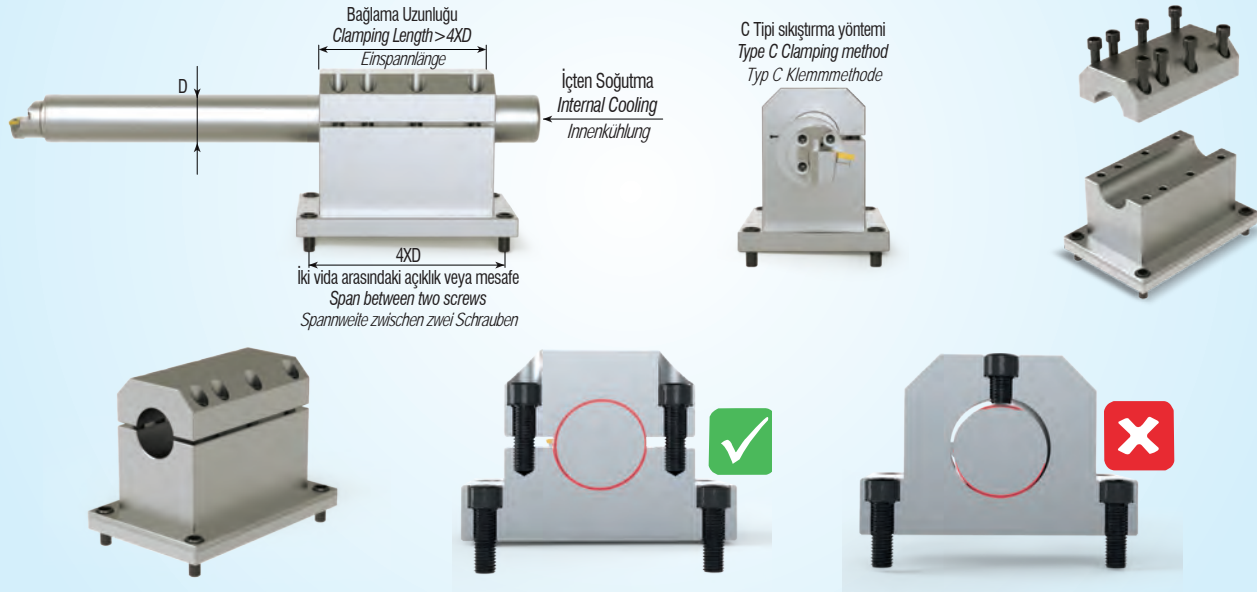

## 3 Merkez Yüksekliğinin Ayarlanması | Adjusting the Height of Centre Assembly | Einstellung der Zentrumhöhe

Gövdeyi ilk kez montaj ederken merkez yüksekliği için özel kalibrasyon aparatı kullanılmalıdır. Önce gövdeyi tutucuya monte edin, ardından X ekseninde 0,01 tolerans içinde kalibre edin. Lütfen komparatör saati ile ayarlamayı yapın.

When mounting the body for the first time, a special calibration tool should be used for the center height. First mount the shank on the holder, then calibrate it within 0.01 tolerance on the X axis direction. Please make the adjustment with the dial indicator device.

Bei der erstmaligen Montage des Schaftes sollte ein spezielles Kalibrierwerkzeug für die Zentrumhöhe verwendet werden. Montieren Sie zuerst den Schaft am Halter und kalibrieren Sie es dann innerhalb einer Toleranz von 0,01 in Richtung der X-Achse. Bitte benutzen Sie bei der Einstellung eine Messuhr

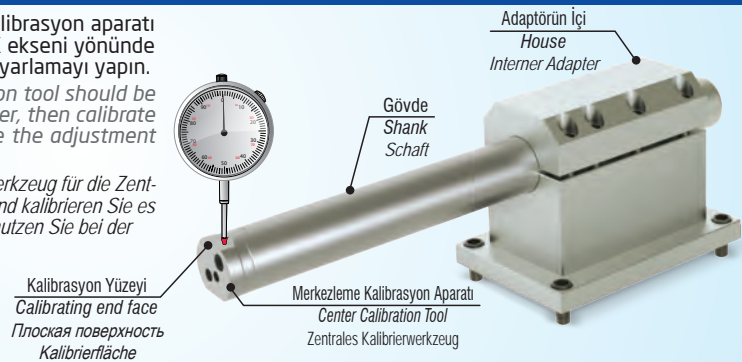

## 4 Doğru Kartuş Montajı | Assembly the Right Cartridge | Richtige Wechselkopfmontage

Yandaki şekle bakın:

See the figure on the side:

Siehe die Abbildung auf der Seite:

Sol Yön Takım  
Left Hand  
Linke Richtung



Sağ Yön Takım  
Right Hand  
Rechte Richtung



**Doğru Uç Seçimi / Choosing the Correct Insert / Auswahl der richtigen Wendeschneidplatte**

Doğru kesici ucun seçilmesi, titreşim sönümlenmenin genel başarısı üzerinde büyük bir etkiye sahiptir. Kesici ucun işleme stabilitesini artırabilmesinin ana yolu kesme kuvvetlerini en aza indirmektir. Titreşimleri ortadan kaldırmak için aşağıdaki adımlara uymanız gerekir: Mümkünse, her zaman kısa takımları kullanın. Aksi takdirde, titreşimi en aza indirmek için hızlarınızı azaltın.

*Choosing the correct insert can have a big influence on the overall success of vibration damping. The main way the insert can improve the machining stability is by minimizing the cutting forces. Following the guidelines below should be your first step to eliminate vibrations: If possible, use it always short drilling tools. Otherwise, reduce your speeds to minimize vibration.*

*Die Auswahl des richtigen Einsatzes kann einen großen Einfluss auf den Gesamterfolg der Schwingungsdämpfung haben. Die Wendeschneidplatte kann die Bearbeitungsstabilität hauptsächlich durch Minimierung der Schneidkräfte verbessern. Das Befolgen der folgenden Richtlinien sollte Ihr erster Schritt sein, um Vibrationen zu beseitigen: Verwenden Sie nach Möglichkeit immer kurze Werkzeuge. Reduzieren Sie andernfalls die Geschwindigkeit, um Vibrationen zu minimieren.*

**A** Radyal kuvvetleri minimuma indirmek için mümkün olduğunca 90° 'ye yakın bir giriş açılı takımı seçin.

*Choose an entry angle that is as close as possible to 90° to reduce the radial forces to a minimum.*

*Wählen Sie einen Eintrittswinkel, der so nah wie möglich an 90° liegt, um die Radialkräfte auf ein Minimum zu reduzieren.*

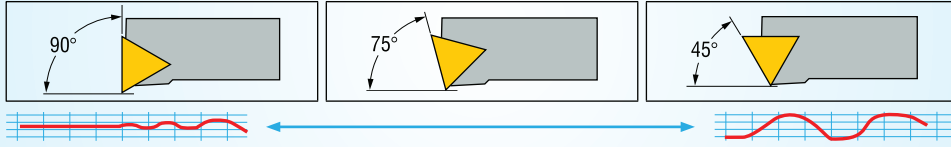

**B** Mümkün olan en küçük kesici uç açısını seçin. Böylece kesme kuvvetleri azalacak ve yüzey kalitesi artacak.

*Choose the smallest insert head angle possible. This will reduce overall cutting forces and increase the clearance.*

*Wählen Sie den kleinstmöglichen Wendeschneidplattenwinkel. Damit wird sich die Gesamtschneidkraft verringern und die Klarheit verbessern.*

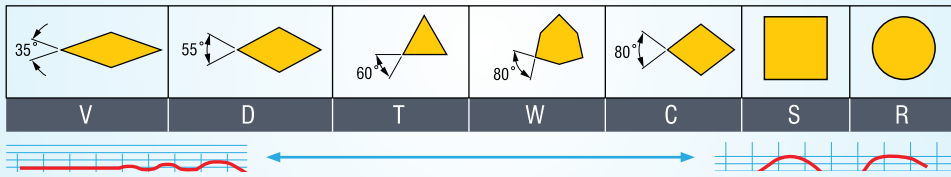

**C** Titreşimi azaltmak için olabildiğince en küçük radyüslü ucu seçmelisiniz.

*Choose a small nose radius to reduce the cutting forces and to enable machining in a lower depth of cut.*

*Wählen Sie einen Eintrittswinkel, der so nah wie möglich an 90° liegt, um die Radialkräfte auf ein Minimum zu reduzieren.*

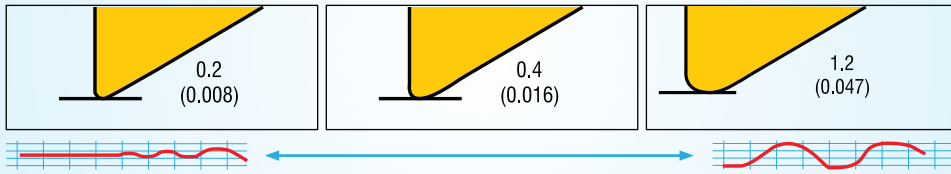

**D** İşleme derinliği (ap) radyüsten daha büyük olmalıdır.

*Machining depth (ap) should be larger than the nose radius.*

*Die Bearbeitungstiefe (ap) sollte größer als der Schneideckenradius sein.*

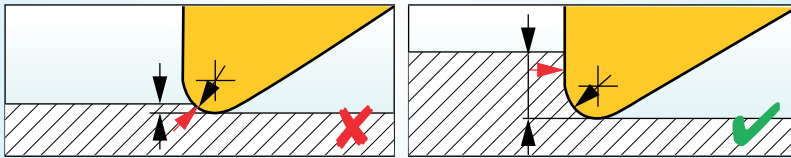

**E** Kesme kuvvetlerini azaltmak için daha pozitif geometriye sahip bir kesici uç kullanın:

*Use an insert with an overall positive geometry to reduce the cutting forces:*

*Verwenden Sie eine Wendeschneidplatte mit insgesamt positiver Geometrie, um die Schneidkräfte zu reduzieren:*

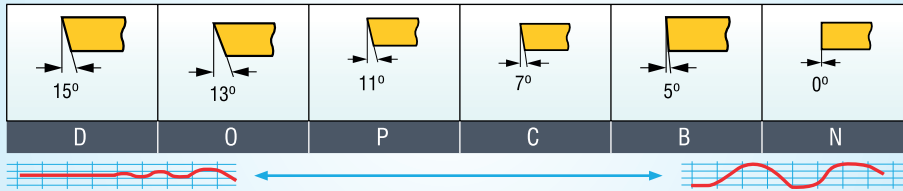

**F** Pozitif bir üst eğim geometrisi seçin:

*Choose a positive top rake geometry:*

*Benutzen Sie einen positiven, oberen Spanwinkel:*

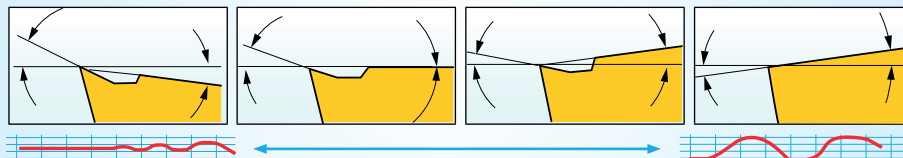

**G** For-dampened-straight-adaptor:

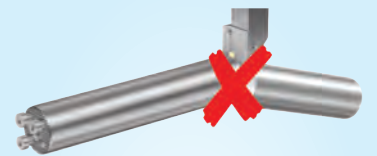

*L, kesildikten sonra min uzunluk*  
*L, min length after cut off*  
*L, min Länge nach dem Abschneiden*

Ø	Kısa Tasarım Short Design Kurzes Design 4-7x Ø (mm)	Uzun Tasarım Long Design Langes Design 7-10x Ø (mm)
16	100	155
20	125	200
25	155	255
32	190	320
40	240	410
50	305	520
60	380	630





*konusulan*  
**the spoken** kalite...  
*quality...*

# KARTUŞLAR

KARTUŞLAR  
CARTRIDGE  
KURZDREHHALTER



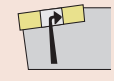
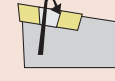

**S** **T** **F** **C** **R** **12** **C** **A** **16**

**1** Sıkma Tipi / Method of Mounting of Insert / Klemmsystem

		
Deliksiz Üstten Sıkma Top Clamping Without Hole Pratzenklemmung	Delikten Levye ile Sıkma Hole Clamping (Lever Lock) Kniehebel-Spannsystem	Vida ile Sıkma Screw on Schrauben-Spannsystem
<b>C</b>	<b>P</b>	<b>S</b>



**2** Uç Tipi / Type of Insert / Plattenform

		
<b>C</b>	<b>S</b>	<b>T</b>

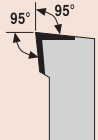
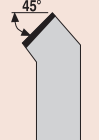
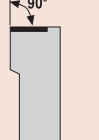
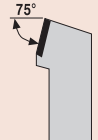
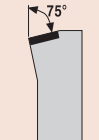
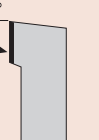
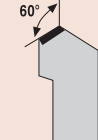
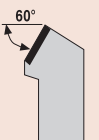
**3** Yanaşma Açısı / Tool Holder Shape Bar Geometry / Anstellwinkel

		
<b>L</b>	<b>S</b>	<b>F</b>
		
<b>R</b>	<b>K</b>	<b>G</b>
		
<b>W</b>	<b>T</b>	

**4** Serbest Uç Açısı / Insert Clearance Angle / Freiwinkel

		
<b>C</b>	<b>P</b>	<b>N</b>

**5** Kesme Yönü / Cutting Direction / Halterausführung

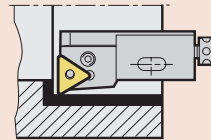
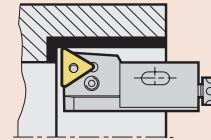
	
<b>R</b>	<b>L</b>

**6** Kesme Kenar Yüksekliği / Cutting Edge Height / Drehhalterhöhe

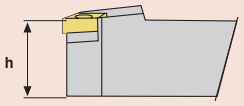



**7** Kartuş Kodu / Cartridge Code / Wechselkopfbezeichnung

**C**  
(Kartuş / Cartridge Code / Kurzdrehhalter Bezeichnung)

**8** Kartuş Tipi / Cartridge Type / Wechselkopftyp

**A**  
(ISO 5611)

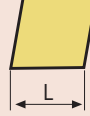
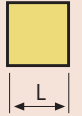
**9** Kesme Kenar Uzunluğu / Cutting Edge Length / Halterausführung

		
<b>L</b>	<b>L</b>	<b>L</b>

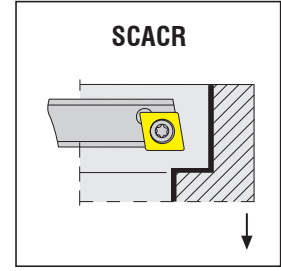
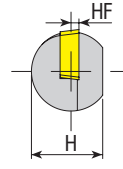
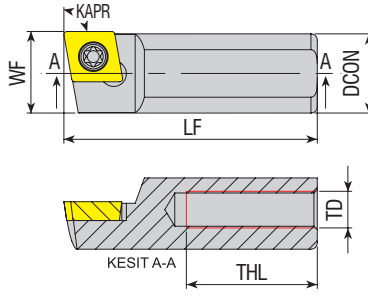

Takım Kodu  
Ordering Code  
Bestell-Bezeichnung

Stok  
Stock  
Lager

Takım Ölçüleri (mm)  
Dimension (mm)  
Abmessung (mm)

Kesici Uç  
Insert  
Wendeschneidplatte

Yedek Parçaları / Spare Parts / Ersatzteile

Sıkma Vidası  
Screw  
Klemmschraube

Tork Anahtar  
Torx Key  
Torx Innensechskantschlüssel

R	L	DCON	H	LF	THL	HF	WF	TD
●	●	10	9	25	10	1	10.3	M5x0.8
●	●	10	9	32	15	1	10.3	M5x0.8
○	●	10	9	18	8	1	9.8	M5x0.8
○	●	10	9	65	25	1	10.3	M5x0.8
●	●	10	9	50	25	1	10.3	M5x0.8
●	●	12	11	40	25	1	12.3	M5x0.8
●	●	12	11	60	25	1	12.3	M5x0.8
●	●	12	11	60	25	2	12.2	M5x0.8
○	●	12	11	65	25	2	12.3	M5x0.8
●	●	12	11	100	25	2	12.2	M5x0.8
●	●	15	14	50	25	2	15.3	M8x1.25
○	●	15	14	54	25	2	15.3	M8x1.25
○	●	15	14	70	45	2	15.3	M8x1.25
○	●	15	14	60	30	2	15.3	M8x1.25
●	●	16	15	32	15	2	16.5	M6x1
●	●	16	15	40	20	2	16.5	M6x1
○	●	16	15	50	25	2	16.5	M6x1
●	●	16	15	60	30	2	16.5	M6x1
○	●	16	15	70	30	2	16.5	M6x1
●	●	16	15	90	30	2	16.5	M6x1
○	●	16	15	100	35	4	16.5	M6x1
○	●	18	17	68	30	2	18.5	M8x1.25
●	●	18	17	70	30	2	18.5	M8x1.25
○	●	18	17	88	30	2	18.5	M8x1.25
○	●	18	17	105	30	2	18.5	M8x1.25
○	●	18	17	175	30	2	18.5	M8x1.25
●	●	20	18.3	70	30	2	20.5	M6x1
●	●	20	18.3	70	30	2	20.5	M6x1
●	●	20	18.3	100	30	2	20.5	M6x1



CC.T 0602..

4008-M2.5x6

82-T08

CC.T 09T3..

4015-M3.5x8

80-T15

CC.T 1204..

1020-M5x11

80-T20

R: Sağ / Right / Rechts L: Sol / Left / Links  
● Stokta / In Stock / Auf Lager ○ Stokta Yok / Non Stock Item / Kein Lagerartikel, Lieferzeit auf Anfrage

Sipariş Örneği/Ordering Example/Bestellbeispiel  
1 ad./pcs./stück S10X SCACR 06

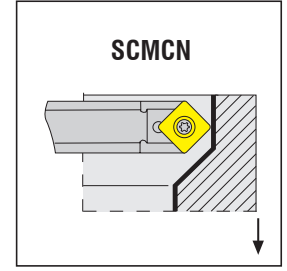
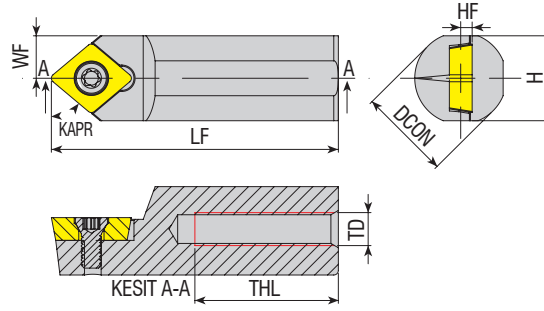

Takım Kodu Ordering Code Bestell-Bezeichnung	Stok Stock Lager	Takım Ölçüleri (mm) Dimension (mm) Abmessung (mm)							Kesici Uç Insert Wendeschneidplatte	Yedek Parçaları / Spare Parts / Ersatzteile		
		DCON	H	LF	THL	HF	WF	TD		Sıkma Vidası Screw Klemmschraube	Tork Anahtar Torx Key Torx Innensechskantschlüssel	
S10X SCMCN 06	●	10	9	25	10	1	5	M5x0.8		4008-M2.5x6	82-T08	
<b>new</b> S10A SCMCN 06	●	10	9	32	15	1	5					
<b>new</b> S10B SCMCN 06	●	10	9	40	20	1	5					
<b>new</b> S10C SCMCN 06	●	10	9	50	25	1	5					
<b>new</b> S10D SCMCN 06	●	10	9	60	25	1	5					
S12D SCMCN 06	●	12	11	60	25	1	6					
S16C SCMCN 09	●	16	15	50	25	2	8	M6x1	CC.T 09T3..	4015-M3.5x11	80-T15	
S16D SCMCN 09	●	16	15	60	25	4	8					

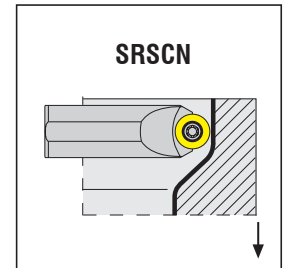
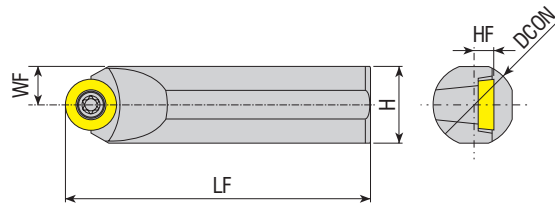

Takım Kodu Ordering Code Bestell-Bezeichnung	Stok Stock Lager	Takım Ölçüleri (mm) Dimension (mm) Abmessung (mm)					Kesici Uç Insert Wendeschneidplatte	Yedek Parçaları / Spare Parts / Ersatzteile		
		DCON	H	WF	HF	LF		Sıkma Vidası Screw Klemmschraube	Tork Anahtar Torx Key Torx Innensechskantschlüssel	
S12D SRSCN 10	●	12	11	6	3.9	60	RC.. 10T3..	4015-M3.5x9	80-T15	
S14D SRSCN 10	●	14	13	7	3.9	60		4015-M3.5x11		
S16D SRSCN 10	●	16	15	8	3.9	60		4015-M3.5x11		

R: Sağ / Right / Rechts L: Sol / Left / Links

● Stokta / In Stock / Auf Lager ○ Stokta Yok / Non Stock Item / Kein Lagerartikel, Lieferzeit auf Anfrage

Sipariş Örneği/Ordering Example/Bestellbeispiel

1 ad./pcs./stück S10X SCMCN 06

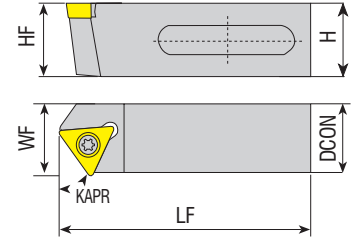

Takım Kodu Ordering Code Bestell-Bezeichnung	Stok Stock Lager		Takım Ölçüleri (mm) Dimension (mm) Abmessung (mm)					Kesici Uç Insert Wendeschneidplatte	Yedek Parçaları / Spare Parts / Ersatzteile		
	R	L	DCON	H	HF	LF	WF		Sıkma Vidası Screw Klemmschraube	Tork Anahtar Torx Key Torx Innensechskantschlüssel	
	○	●									
STXCR/L 2020 B16	○	●	20	20	20	45	20	TC.. 16T3..	4015-M3.5x11	80-T15	
STXCR/L 2020 E16	○	●	20	20	20	70	20				
STXCR/L 2020 B16-SA	○	●	20	10	20	45	20				
STXCR/L 2020 E16-SA	○	●	20	10	20	70	20				
STXCR/L 2020 B16-PL	○	●	20	10	20	45	20				
STXCR/L 2020 E16-PL	○	●	20	10	20	70	20				
STXCR/L 2020 H16-PL	○	●	20	10	20	100	20				

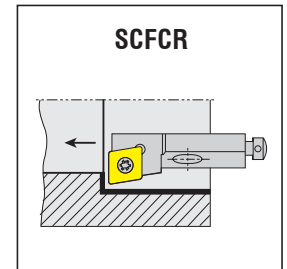
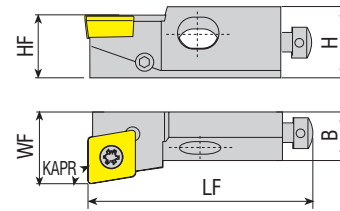
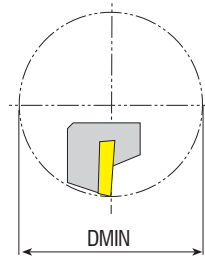

Takım Kodu Ordering Code Bestell-Bezeichnung	Stok Stock Lager		Takım Ölçüleri (mm) Dimension (mm) Abmessung (mm)						Kesici Uç Insert Wendeschneidplatte	Yedek Parçaları / Spare Parts / Ersatzteile			
	R	L	HF	H	B	LF	WF	DMIN		Altlık Shim Unterlage	Altlık Vidası Shim Screw Schraube für Unterlage	Sıkma Vidası Screw Klemmschraube	Tork Anahtar Torx Key Torx Innensechskantschlüssel
	○	●											
SCFCR/L 06CA 06	●	●	6	8.5	6	25	8	≥20	CC.T 060204	-	-	4008-M2.5x6	82-T08
SCFCR/L 08CA 06	●	●	8	11	8	32	10	≥25					
SCFCR/L 10CA 09	●	●	10	15	11	50	14	≥40					
SCFCR/L 12CA 12	●	○	12	20	15	55	20	≥50					
SCFCR/L 16CA 12	●	●	16	21	20	63	25	≥60					
									AACN-2-0003	AAV-10-M4.5x8	4020-M4.5x12	80-T20	









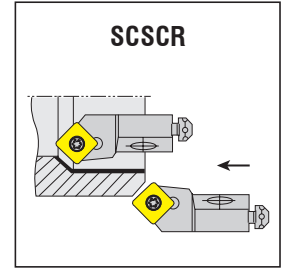
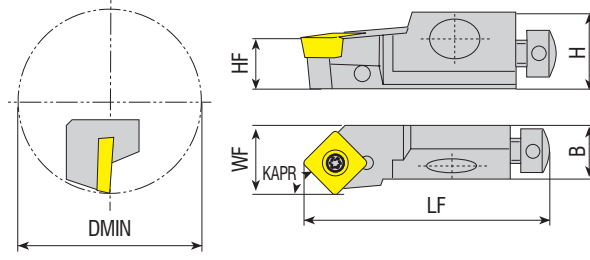





R: Sağ / Right / Rechts L: Sol / Left / Links

● Stokta / In Stock / Auf Lager ○ Stokta Yok / Non Stock Item / Kein Lagerartikel, Lieferzeit auf Anfrage

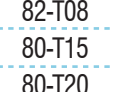





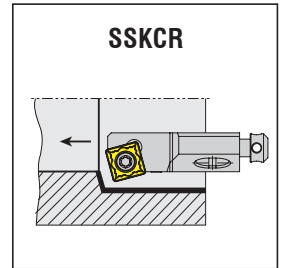
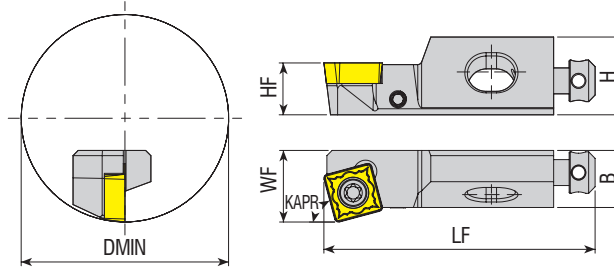

Sipariş Örneği/Ordering Example/Bestellbeispiel

1 ad./pcs./stück STXCR 2020 B16

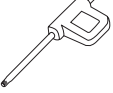

Takım Kodu Ordering Code Bestell-Bezeichnung	Stok Stock Lager		Takım Ölçüleri (mm) Dimension (mm) Abmessung (mm)						Kesici Uç Insert Wendeschneidplatte	Yedek Parçaları / Spare Parts / Ersatzteile			
	R	L	HF	H	B	LF	WF	DMIN		Altlık Shim Unterlage	Altlık Vidası Shim Screw Schraube für Unterlage	Sıkma Vidası Screw Klemmschraube	Tork Anahtar Torx Key Torx Innensechskantschlüssel
SCSCR/L 06CA 06	●	○	6	8	6	30	8	≥20					
SCSCR/L 10CA 09	●	○	10	15	11	50	14	≥40					
SCSCR/L 12CA 12	○	○	12	20	15	55	20	≥50					

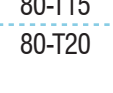

Takım Kodu Ordering Code Bestell-Bezeichnung	Stok Stock Lager		Takım Ölçüleri (mm) Dimension (mm) Abmessung (mm)						Kesici Uç Insert Wendeschneidplatte	Yedek Parçaları / Spare Parts / Ersatzteile			
	R	L	HF	H	B	LF	WF	DMIN		Altlık Shim Unterlage	Altlık Vidası Shim Screw Schraube für Unterlage	Sıkma Vidası Screw Klemmschraube	Tork Anahtar Torx Key Torx Innensechskantschlüssel
SSKCR/L 10CA 09	●	○	10	15	11	50	14	≥40					
SSKCR/L 12CA 12	●	○	12	20	15	55	20	≥50					

R: Sağ / Right / Rechts L: Sol / Left / Links

● Stokta / In Stock / Auf Lager ○ Stokta Yok / Non Stock Item / Kein Lagerartikel, Lieferzeit auf Anfrage

Sipariş Örneği/Ordering Example/Bestellbeispiel

1 ad./pcs./stück SCSCR 06CA 06

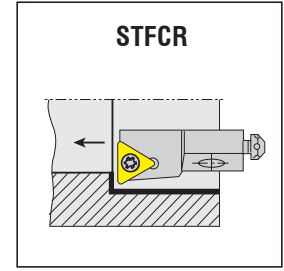
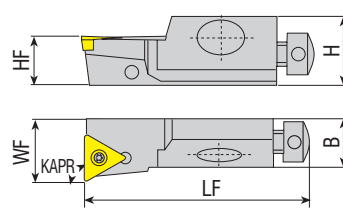
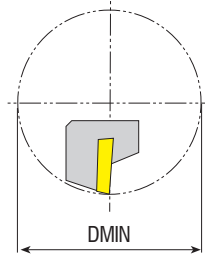

**Takım Kodu**  
**Ordering Code**  
**Bestell-Bezeichnung**

Takım Kodu Ordering Code Bestell-Bezeichnung	Stok Stock Lager		Takım Ölçüleri (mm) Dimension (mm) Abmessung (mm)						Kesici Uç Insert Wendeschneidplatte	Yedek Parçaları / Spare Parts / Ersatzteile				
	R	L	HF	H	B	LF	WF	DMIN		Altlık Shim Unterlage	Altlık Vidası Shim Screw Schraube für Unterlage	Sıkma Vidası Screw Klemmschraube	Tork Anahtar Torx Key Torx Innensechskantschlüssel	
STFCR/L 08CA 09	●	●	8	11	8	32	10	≥25	TC.T 090204	-	-	3007-M2.2x4.6	82-T07	
STFCR/L 10CA 11	●	●	10	15	11	50	14	≥40		TC.T 110204	-	-	4008-M2.5x6	82-T08
STFCR/L 12CA 16	●	○	12	20	15	55	20	≥50		TC.T 16T308	-	-	4015-M3.5x11	80-T15
STFCR/L 16CA 16	●	●	16	21	20	63	25	≥60			AATN-2-0001	AAV-06-M3.5x11	4015-M3.5x14	

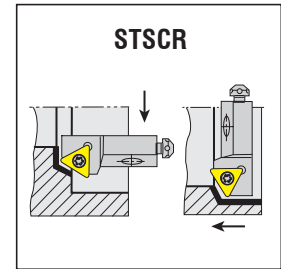
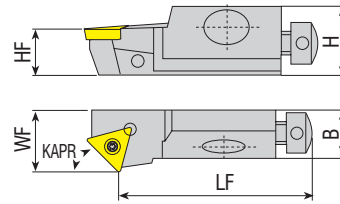
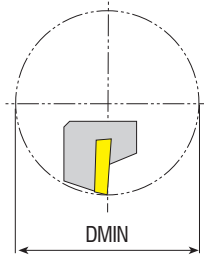

**Takım Kodu**  
**Ordering Code**  
**Bestell-Bezeichnung**

Takım Kodu Ordering Code Bestell-Bezeichnung	Stok Stock Lager		Takım Ölçüleri (mm) Dimension (mm) Abmessung (mm)						Kesici Uç Insert Wendeschneidplatte	Yedek Parçaları / Spare Parts / Ersatzteile				
	R	L	HF	H	B	LF	WF	DMIN		Altlık Shim Unterlage	Altlık Vidası Shim Screw Schraube für Unterlage	Sıkma Vidası Screw Klemmschraube	Tork Anahtar Torx Key Torx Innensechskantschlüssel	
STSCR/L 08CA 09	●	○	8	11	8	28	10	≥25	TC.T 090204	-	-	3007-M2.2x4.6	82-T07	
STSCR/L 10CA 11	●	●	10	15	11	44	14	≥40		TC.T 110204	-	-	4008-M2.5x6	82-T08
STSCR/L 12CA 16	●	○	12	20	15	47	20	≥50		TC.T 16T308	-	-	4015-M3.5x11	80-T15

R: Sağ / Right / Rechts L: Sol / Left / Links  
● Stokta / In Stock / Auf Lager ○ Stokta Yok / Non Stock Item / Kein Lagerartikel, Lieferzeit auf Anfrage

Sipariş Örneği/Ordering Example/Bestellbeispiel  
1 ad./pcs./stück STFCR 08CA 09

> S-SİSTEM KARTUŞLAR  
S-SYSTEM CARTRIDGE  
S-SYSTEM KURZDREHHALTER

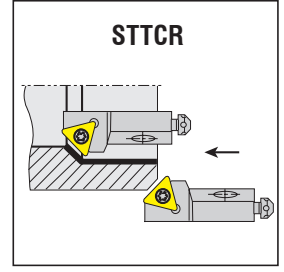
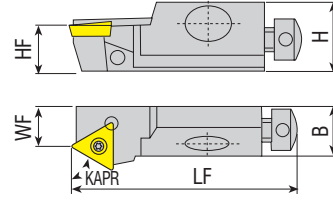
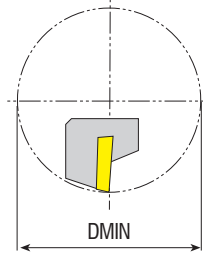

Takım Kodu Ordering Code Bestell-Bezeichnung	Stok Stock Lager		Takım Ölçüleri (mm) Dimension (mm) Abmessung (mm)						Kesici Uç Insert Wendeschneidplatte	Yedek Parçaları / Spare Parts / Ersatzteile			
	R	L	HF	H	B	LF	WF	DMIN		Altlık Shim Unterlage	Altlık Vidası Shim Screw Schraube für Unterlage	Sıkma Vidası Screw Klemmschraube	Tork Anahtar Torx Key Torx Innerschraubenschlüssel
STTCR/L 08CA 09	●	●	8	11	8	32	6	≥25		-	-	3007-M2.2x4.6	82-T07
STTCR/L 10CA 11	●	●	10	15	11	50	9	≥40		-	-	4008-M2.5x6	82-T08
<b>new</b> STTCR/L 12CA 16	●	○	12	20	14.8	55	20	≥50		-	-	4015-M3.5x9	80-T15

> P-SİSTEM KARTUŞLAR  
P-SYSTEM CARTRIDGE  
P-SYSTEM KURZDREHHALTER

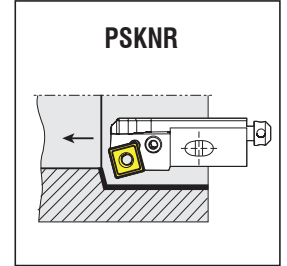
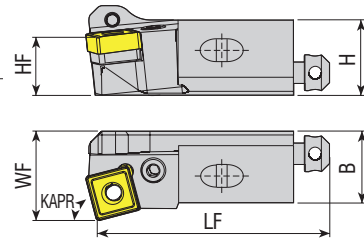
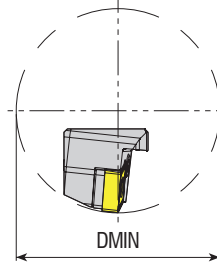

Takım Kodu Ordering Code Bestell-Bezeichnung	Stok Stock Lager		Takım Ölçüleri (mm) Dimension (mm) Abmessung (mm)						Kesici Uç Insert Wendeschneidplatte	Yedek Parçaları / Spare Parts / Ersatzteile				
	R	L	HF	H	B	LF	WF	DMIN		Levye Lever Kniehebel	Levye Vidası Lever Screw Kniehebelschraube	Altlık Shim Unterlage	Altlık Yayı Shim Spring Feder für Unterlage	Anahtar Allen Key Innerschraubenschlüssel
PSKNR/L 16CA 12	●	●	16	21	20	63	25	≥60		APL-02	ALV-08-M8x16	AASN-3-0004	AAY-02	AAL-02-2.5

R: Sağ / Right / Rechts L: Sol / Left / Links  
● Stokta / In Stock / Auf Lager ○ Stokta Yok / Non Stock Item / Kein Lagerartikel, Lieferzeit auf Anfrage

Sipariş Örneği/Ordering Example/Bestellbeispiel  
1 ad./pcs./stück STTCR 08CA 09



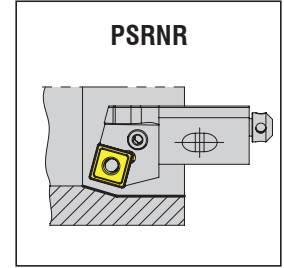
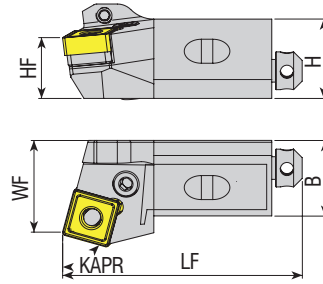
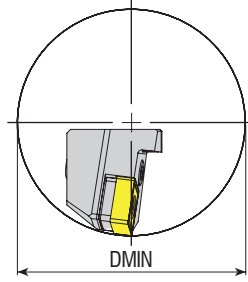

Takım Kodu  
Ordering Code  
Bestell-Bezeichnung

Stok Stock Lager	Takım Ölçüleri (mm) Dimension (mm) Abmessung (mm)								Kesici Uç Insert Wendeschneidplatte	Yedek Parçaları / Spare Parts / Ersatzteile				
	R	L	HF	H	B	LF	WF	DMIN		Levyeye Lever Kniehebel	Levyeye Vidası Lever Screw Kniehebelschraube	Altılık Shim Unterlage	Altılık Yayı Shim Spring Feder für Unterlage	Anahtar Allen Key Innensechskantschlüssel
PSRNR/L 16CA 12	○	●	16	21	20	63	25	≥60	SNM.120408	APL-02	ALV-03-M8x19	AASN-3-0004	AAV-02	AAL-03-3

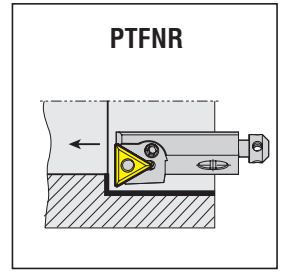
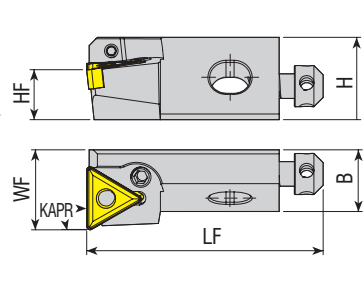
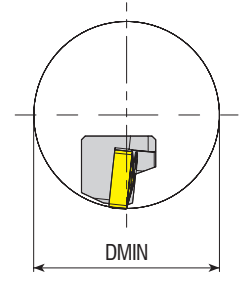

Takım Kodu  
Ordering Code  
Bestell-Bezeichnung

Stok Stock Lager	Takım Ölçüleri (mm) Dimension (mm) Abmessung (mm)								Kesici Uç Insert Wendeschneidplatte	Yedek Parçaları / Spare Parts / Ersatzteile				
	R	L	HF	H	B	LF	WF	DMIN		Levyeye Lever Kniehebel	Levyeye Vidası Lever Screw Kniehebelschraube	Altılık Shim Unterlage	Altılık Yayı Shim Spring Feder für Unterlage	Anahtar Allen Key Innensechskantschlüssel
PTFNR/L 12CA 16	●	●	12	20	15	47	20	≥50	TNM.160408	APL-08	ALV-07-M6x13	-	AAV-07	AAL-02-2.5
PTFNR/L 16CA 16	●	○	16	21	20	63	25	≥60		APL-01	ALV-01-M6x14	AATN-3-0025	AAV-01	AAL-02-2.5
new PTFNR/L 16CA 22	○	●	16	21	20	63	25	≥60	TNMG 2204.	APL-02	ALV-03-M8x19	AATN-3-0015	AAV-02	AAL-03-3
new PTFNR/L 20CA 22	●	○	20	30	20	63	25	≥70						

new

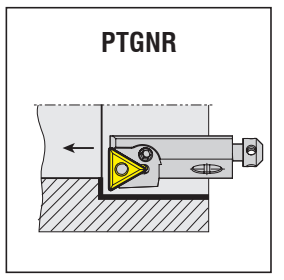
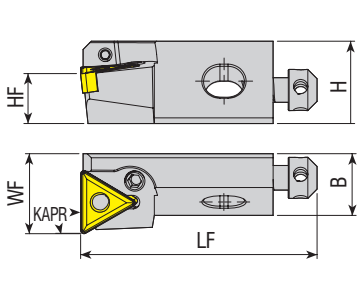
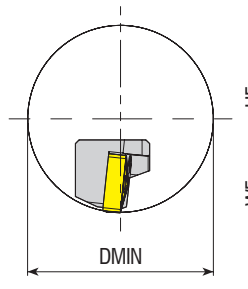

Takım Kodu  
Ordering Code  
Bestell-Bezeichnung

Stok Stock Lager	Takım Ölçüleri (mm) Dimension (mm) Abmessung (mm)								Kesici Uç Insert Wendeschneidplatte	Yedek Parçaları / Spare Parts / Ersatzteile				
	R	L	HF	H	B	LF	WF	DMIN		Levyeye Lever Kniehebel	Levyeye Vidası Lever Screw Kniehebelschraube	Altılık Shim Unterlage	Altılık Yayı Shim Spring Feder für Unterlage	Anahtar Allen Key Innensechskantschlüssel
PTGNR/L 16CA 22	●	●	16	21	20	63	25	60	TNMG 2204..	APL-02	ALV-03-M8x19	AATN-3-0015	AAV-02	AAL-03-3

R: Sağ / Right / Rechts L: Sol / Left / Links  
● Stokta / In Stock / Auf Lager ○ Stokta Yok / Non Stock Item / Kein Lagerartikel, Lieferzeit auf Anfrage

Sipariş Örneği/Ordering Example/Bestellbeispiel  
1 ad./pcs./stück PSRNR 16CA 12

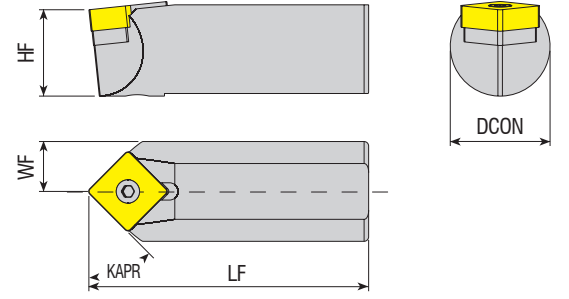

Takım Kodu Ordering Code Bestell-Bezeichnung	Stok Stock Lager	Takım Ölçüleri (mm) Dimension (mm) Abmessung (mm)				Kesici Uç Insert Wendeschneidplatte	Yedek Parçaları / Spare Parts / Ersatzteile				
		DCON	HF	LF	WF		Aitlik Shim Unterlage	Sıkma Vidası Screw Klemmschraube	Baskı Parçası Wedge Clamp Spannpratze	Baskı Vidası Clamp Screw Klemmschraube	Tork Anahtar Torx Key Torx Innensechskantschlüssel
<b>S22D PSDNN 12C</b>	●	22	17.5	65	11						
						<b>SNM. 1204..</b>	AASN-20020	AEV-01-M6x16	ACK-05	4015-M4x11	AAL-02-2.5

R: Sağ / Right / Rechts L: Sol / Left / Links

● Stokta / In Stock / Auf Lager ○ Stokta Yok / Non Stock Item / Kein Lagerartikel, Lieferzeit auf Anfrage

Sipariş Örneği/Ordering Example/Bestellbeispiel

1 ad./pcs./stück S22D PSDNN 12C

KARTUŞLARIN YEDEK PARÇALARI  
SPARE PARTS OF CARTRIDGE  
ERSATZTEILE FÜR KURZDREHHALTER

Takım Kodu Ordering Code Bestell-Bezeichnung	Yedek Parçaları / Spare Parts / Ersatzteile					
	Eksenel Ayar Vida Axial Adj. Screw Axial-Einstellschraube	Radyal Ayar Vida Radial Adj. Screw Radial-Einstellschraube	Radyal Ayar Vida Anahtar Radial Adj. Screw Allen Key Innensechskantschlüssel für Radial-Einstellschraube	Montaj Vida Mounting Screw Befestigungsschraube	Montaj Vida Anahtar Mounting Screw Allen Key Innensechskantschlüssel für Befestigungsschraube	
<b>SCFCR/L</b>	06CA 06	2600-M4x9.5	2715-M3x5	AAL-09-1.5	AKV-23-M4x10	AAL-03-3
<b>SCSCR/L</b>	08CA 06	2600-M4x9.5	2715-M3x5	AAL-09-1.5	AKV-23-M4x10	AAL-03-3
<b>SSKCR/L</b>	10CA 09	2600-M5x13	2702-M4x10	AAL-01-2	2505-M6x16	AAL-03-3
	12CA 12	2600-M5x13	2702-M4x10	AAL-01-2	2505-M6x16	AAL-03-3
	16CA 12	2600-M6x18	2725-M5x12	AAL-02-2.5	2005-M8x25	AAL-07-5
<b>STSCR/L</b>	08CA 09	2600-M4x9.5	2715-M3x5	AAL-09-1.5	AKV-23-M4x10	AAL-03-3
<b>STTCR/L</b>	10CA 11	2600-M5x13	2702-M4x10	AAL-01-2	2505-M6x16	AAL-03-3
<b>STFCR/L</b>	12CA 16	2600-M5x13	2702-M4x10	AAL-01-2	2505-M6x16	AAL-03-3
	16CA 16	2600-M6x18	2725-M5x12	AAL-02-2.5	2005-M8x25	AAL-07-5
<b>PTFNR/L</b>	12CA 16	2600-M5x13	2702-M4x4	AAL-01-2	2505-M6x16	AAL-03-3
<b>PSKNR/L</b>	16CA 16	2600-M6x18	2725-M5x6	AAL-02-2.5	2005-M8x25	AAL-07-5
<b>PSRNR/L</b>	16CA 12	2600-M6x18	2725-M5x6	AAL-02-2.5	2005-M8x25	AAL-07-5



Takım Kodu Ordering Code Bestell-Bezeichnung	Stok Stock Lager	Ölçü Aralığı (mm) Boring Range (mm) Bohrbereich (mm)					Kartuşlar Cartridge Kurzdrehhalter	Gövde Takım Kodu Body Tool Code Grundkörper-Bezeichnung	Teknik Çizim Technical Draw Technische Zeichnung
		D max		D min		Max (D dış-D iç) (D out-D in)			
		D iç D in	D dış D out	D iç D in	D dış D out				
ACPBT-1	●	27-52	52	18-36	36	27	ÖTG-K-120-20		
ACPBT-2	●	27-49	52	25-36	36	27			
ACPBT-3	●	48-75	75	41	42	27			
ACPBT-4	●	51-75	75	51	52	27			
ACPBT-5	●	22-35	35	22	23	27			
ACPBT-6	●	15-35	35	15	16	27			
ACPBT-7	●	49-53	75	32-36	36	27			
ACPBT-8	●	49	75	33-37	37	27			

Takım Kodu Ordering Code Bestell-Bezeichnung	Stok Stock Lager	Ölçü Aralığı (mm) Boring Range (mm) Bohrbereich (mm)					Kartuşlar Cartridge Kurzdrehhalter	Gövde Takım Kodu Body Tool Code Grundkörper-Bezeichnung	Teknik Çizim Technical Draw Technische Zeichnung
		D1		D2		Max (D dış-D iç) (D out-D in)			
		D max	D min	D max	D min				
ACPBT-9	●	38	24	15	1	-	ÖTG-K-120-20		
ACPBT-10	●	78	64	43	29	-			

R: Sağ / Right / Rechts L: Sol / Left / Links

● Stokta / In Stock / Auf Lager ○ Stokta Yok / Non Stock Item / Kein Lagerartikel, Lieferzeit auf Anfrage

Sipariş Örneği / Ordering Example / Bestellbeispiel

1 ad./pcs./stück ACPBT-1



*konusulan  
the spoken kalite...  
quality...*

# DİŞ AÇMA

DİŞ AÇMA TAKIMLARI  
THREADING TOOLHOLDERS  
GEWINDE DREHHALTER





**S**

1

**E**

2

**R**

3

**25 25**

4-5

**M**

6

**16**

7

**C**

8

**1** Sıkma Tipi / Method of Mounting of Insert  
 Klemmsystem

S: Vida Sıkmalı  
 S: Screw Clamping / S Schrauben-Spannsystem  
 T: Vida Sıkmalı Helis Açılı  
 T: Screw Clamping with Helix Angle  
 T: Schraubenklemmung für unterschiedliche Einstellwinkel

**2** İşlem Tipi / Application  
 Anwendung

E: Dış / External  
 Außen  
 I: İç / Internal /  
 Innen

**3** Kesme Yönü  
 Cutting Direction  
 Halterausführung

R: Sağ Yan  
 Right-Hand  
 R: Rechts

L: Sol Yan  
 Left-Hand  
 L: Links

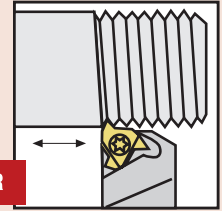

**S E L**

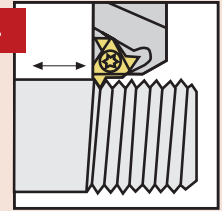

**4** Takım Malzemesi / Type of Boring / Art der Bohrstange

"A" Yekpare çelik gövde soğutma suyu kanallı / "A" Solid steel with coolant hole  
 A" Stahlschaft mit Kühlbohrung SEITE 123  
 "E" Çelik başlıkla sert metal gövde ve soğutma suyu kanallı / "E" Carbide bar with fixed steel head and coolant hole  
 "E" Hartmetallstange mit festem Stahlkopf und Kühlmittelbohrung  
 "C" Karbür Şaft / "C" Carbide shank / "C" Hartmetallschaft  
 "S" Çelik Şaft / "S" Steel shank / "S" Stahlschaft

**4-5** Dış Çap Şaft Ölçüleri / External Shank Size  
 Äußere Schaftgröße

Şaft / Shank / Schaftausführung: hxb  
 2525 - 25 x 25 mm

**5** Şaft Çapı / Shank Diameter  
 Schaft-Durchmesser

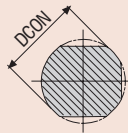

**6** Şaft Boyu / Shank Length / Schaftlänge

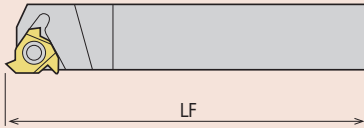

A - 32	H - 100	Q - 180	x-special
B - 40	J - 110	R - 200	
C - 50	K - 125	S - 250	
D - 60	L - 140	T - 300	
E - 70	M - 150	U - 350	
F - 80	N - 160	V - 400	
G - 90	P - 170	W - 450	

**7** Elmas Ölçüsü / Insert Size  
 Wendeplattengröße

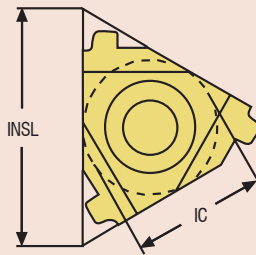

l (mm)	d
06	5/32"
08	3/16"
11	1/4"
16	3/8"
22	1/2"
27	5/8"

**8** Baskı Pabucu  
 Wedge Clamp  
 Spannpratze

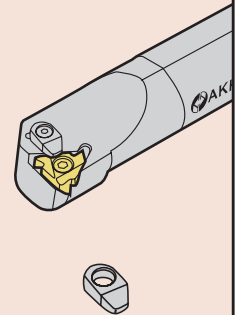

**S**

1

**I**

2

**R**

3

**S**

4

**25**

5

**R**

6

**16**

7

**C**

8

DIŞ ÇAP DIŞ AÇMA KATERLERİ  
EXTERNAL THREADING TOOLHOLDERS  
INNEN-GEWINDEDREHHALTER

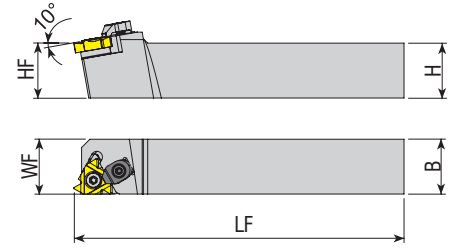
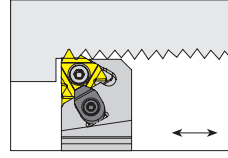

Takım Kodu Ordering Code Bestell-Bezeichnung	Stok Stock Lager		Takım Ölçüleri (mm) Dimension (mm) Abmessung (mm)				Kesici Uç Insert Wendeschneidplatte	Sıkma Vidası Screw Klemmschraube	Altlık Shim Unterlage	Altlık Vidası Shim Screw Schraube für Unterlage	Baskı Parçası Wedge Clamp Spannpratze	Baskı Vidası Clamp Screw Klemmschraube	Tork Anahtar Torx Immersionschlüssel
	R	L	HF=H	B	LF	WF							
SER/L 0808 E11	●	●	08	08	70	11	11 ER/EL	4008-M2.5x6	-	-	-	-	82-T08
SER/L 1010 E11	●	●	10	10	70	11							
SER/L 1212 F11	●	●	12	12	80	12							
SER/L 1616 H11	●	●	16	16	100	16							
SER/L 2020 H11	●	●	20	20	100	20	16 ER/EL (0.35 - 3) ISO METRIC	4015-M3.5x14	AATN-2-0020	AAV-06-M3.5x11	-	-	80-T15
SER/L 1616 H16C	●	●	16	16	100	16							
SER/L 2020 K16C	●	●	20	20	125	20							
SER/L 2525 M16C	●	●	25	25	150	25							
SER/L 3232 P16C	●	●	32	32	170	32	22 ER/EL (3.5 - 4.5) ISO METRIC	1020-M4.5x16	AATN-2-0004	AAV-07-M4.5x13	ACK-05	4015 M4x11	80-T20
SER/L 2525 M22C	●	●	25	25	150	25							
SER/L 3232 P22C	●	●	32	32	170	32							
SER/L 4040 S22C	●	●	40	40	250	40							
SER/L 2525 M16C-T	●	●	25	25	150	25	16 ER/L (1.5-3 TR)	4015-M3.5x14	-	-	-	-	80-T15
SER/L 2525 M22C-T	●	●	25	25	150	25	22 ER/L (4-6 TR)	1020-M4.5x16	-	-	-	-	80-T20
SER/L 2020 K16C-S	●	●	20	20	125	25	SNDVK 166 ER/L16	4015-M3.5x14	AATN-2-0020	AAV-06-M3.5x11	-	-	80-T15
SER/L 2525 M16C-S	●	●	25	25	150	31							
SER/L 3232 P16C-S	●	●	32	32	170	38.5							

DIŞ ÇAP DIŞ AÇMA İSVİÇRE TİPİ KAYAR OTOMAT MAKİNA KATERLERİ  
EXTERNAL THREADING TOOLHOLDERS FOR SWISS TYPE SLIDING AUTOMATIC LATHES  
AUSSEN-GEWINDEDREHHALTER FÜR LANGDREHAUTOMATEN

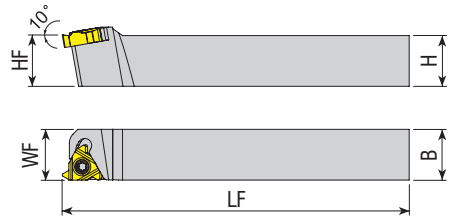
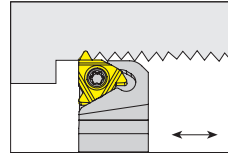

Takım Kodu Ordering Code Bestell-Bezeichnung	Stok Stock Lager		Takım Ölçüleri (mm) Dimension (mm) Abmessung (mm)				Kesici Uç Insert Wendeschneidplatte	Sıkma Vidası Screw Klemmschraube	Altlık Shim Unterlage	Altlık Vidası Shim Screw Schraube für Unterlage	Baskı Parçası Wedge Clamp Spannpratze	Baskı Vidası Clamp Screw Klemmschraube	Tork Anahtar Torx Immersionschlüssel
	R	L	HF=H	B	LF	WF							
SER/L 1010 K11-S	●	●	10	10	125	10	11 ER/EL	4008-M2.5x6	-	-	-	-	82-T08
SER/L 1212 K11-S	●	●	12	12	125	12							
SER/L 1212 K16-S	●	●	12	12	125	12							
SER/L 1212 K16-S	●	●	12	12	125	12	16 ER 3.5	4015-M3.5x14	AATN-2-0020	AAV-08-M3.5x8	-	-	80-T15

R: Sağ / Right / Rechts L: Sol / Left / Links ● Stokta / In Stock / Auf Lager ○ Stokta Yok / Non Stock Item / Kein Lagerartikel, Lieferzeit auf Anfrage  
Takımlar standart 1.5° helis açılı olarak üretilir. / The tools have a built in 1.5° helix angle. / GEWINDE-DREHHALTER werden mit Einstellwinkel 1.5° hergestellt  
UYARI / WARNING / ПРЕДУПРЕЖДЕНИЕ: Sayfa 114'deki B ve D figürleri uygulanamaz. / The operation for B and D on page 114 can not be applied. / 130: für Abbildung B und D: nicht verwenden

Sipariş Örneği/Ordering Example/Bestellbeispiel  
1 ad./pcs./stück SER 0808 E11



www.akko.com.tr

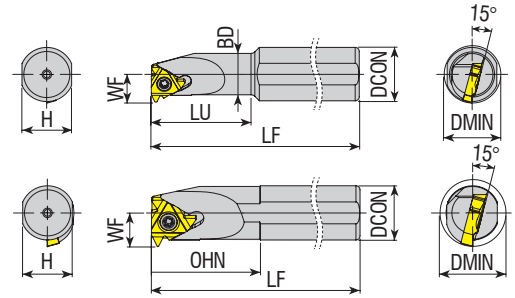
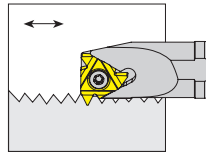

Takım Kodu Ordering Code Bestell-Bezeichnung	Stok Stock Lager		Takım Ölçüleri (mm) Dimension (mm) Abmessung (mm)					Kesici Uç Insert Wendeschneidplatte	Yedek Parçaları / Spare Parts / Ersatzteile						
	R	L	DCON	BD	LF	LU=OHN	WF		DMIN	Sıkma Vidası Screw Klemmschraube	Ahtlık Shim Unterlage	Ahtlık Vidası Shim Screw Schraube für Unterlage	Baskı Parçası Wedge Clamp Spannpratze	Baskı Vidası Clamp Screw Klemmschraube	Tork Anahtar Torx Key Torx Innenschlüssel
SIR/L S12X05H 06	●	○	12	05	100	15	4.3	6.4	06 IR/L	3006-M2X3.6	-	-	-	-	82-T06
SIR/L S16X05H 06	○	●	16	05	100	15	4.3	6.4							
SIR/L S16X07M 08	●	●	16	07	150	18	5.3	7.8							
SIR/L S10H 11	●	●	10	10	100	-	7.4	12	11 IR/L	4008-M2.5x6	-	-	-	-	82-T08
SIR/L S12K 11	●	●	12	12	125	-	8.4	15							
SIR/L S16X10M 11	●	●	16	10	150	25	7.4	12							
SIR/L S16X13M 11	●	●	16	13	150	32	8.9	15							
SIR/L S16M 11	●	●	16	16	150	-	11.7	19							
new SIR/L A16X13M 16	●	●	16	12.8	150	32	9.05	18.1	16 IR/L (0.35 - 3) ISO METRIC	4015-M3.5x9	-	-	-	-	80-T15
SIR/L S16X13M 16	●	●	16	13	150	32	10.2	16							
SIR/L S16M 16	●	●	16	16	150	-	11.7	19							
SIR/L S20X16P 16	●	●	20	16	170	40	11.7	19							
new SIR/L A20X16P 16	●	●	20	31	170	40	11.7	19							
SIR/L S20P 16	●	●	20	20	170	-	13.7	24							
SIR/L S25R 16C	●	●	25	25	200	-	16.2	29							
SIR/L S32S 16C	●	●	32	32	250	-	19.7	36							
SIR/L S40T 16C	●	●	40	40	300	-	23.7	44							
SIR/L S50U 16C	●	●	50	50	350	-	28.7	54							
SIR/L S20P 22	●	●	20	20	170	-	15.7	24	22 IR/L (3.5 - 4.5) ISO METRIC	4020-M4.5x12	-	-	-	-	80-T20
SIR/L S25R 22C	●	●	25	25	200	-	18.1	29							
SIR/L S32S 22C	●	●	32	32	250	-	21.6	38							
SIR/L S40T 22C	●	●	40	40	300	-	25.6	46							
SIR/L S50U 22C	●	●	50	50	350	-	30.6	58							
SIR/L S25R 16C-T	●	●	25	25	200	-	16.2	29							
SIR/L S32S 16C-T	●	●	32	32	250	-	19.7	36	22 IR/L (4-6 TR)	1020-M4.5x16	-	-	-	-	80-T20
SIR/L S25R 22C-T	●	●	25	25	200	-	18.1	29							
SIR/L S32S 22C-T	●	●	32	32	250	-	21.6	38							
new SIR/L S40T 27V T08	●	●	40	39.5	300	70	29	50	27VNR10TR NNT	1620-M5X18	-	-	-	-	-

R: Sağ / Right / Rechts L: Sol / Left / Links ● Stokta / In Stock / Auf Lager ○ Stokta Yok / Non Stock Item / Нет в наличии  
Takımlar standart 1.5° helis açılı olarak üretilir. / The tools have a built in 1.5° helix angle. / GEWINDE-DREHHALTER werden mit Einstellwinkel 1.5° hergestellt  
UYARI / WARNING / ПРЕДУПРЕЖДЕНИЕ: Sayfa 115'deki B ve D figürleri uygulanamaz. / The operation for B and D on page 115 can not be applied. / 130. für Abbildung B und D: nicht verwenden

Sipariş Örneği/Ordering Example/Bestellbeispiel  
1 ad./pcs./stück SIR S12X05H 06

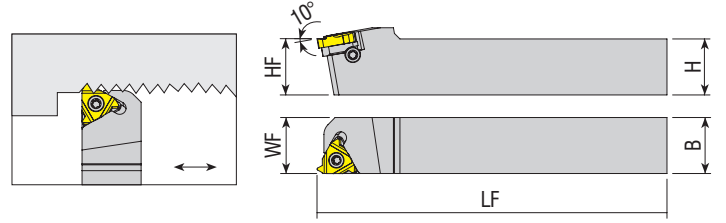
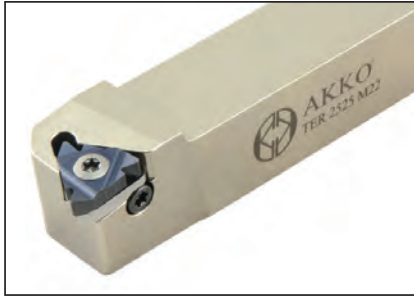

Takım Kodu Ordering Code Bestell-Bezeichnung	Stok Stock Lager		Takım Ölçüleri (mm) Dimension (mm) Abmessung (mm)				Kesici Uç Insert Wendeschneidplatte	Yedek Parçaları / Spare Parts / Ersatzteile					
	R	L	HF=H	B	LF	WF		Sıkma Vidası Screw Klemmschraube	Sağ Altlık Right Shim U-Platte für WSP rechts	Sol Altlık Left Shim U-Platte für WSP links	Altlık Vidası Shim Screw Schraube für Unterlage	Altlık Vidası Pulu Shim Screw Ring Schraube für Unterlagering	Tork Anahtar Torx Key Torx / Innenschlankschlüssel
TER/L 1616 H16	●	●	16	16	100	16	16 ER/EL	1710-U5-40x12.2	ATS-16E	ATS-16I	AAV-11-U5-40x4.5	ABPL-03	82-T10
TER/L 2020 K16	●	●	20	20	125	20							
TER/L 2525 M16	●	●	25	25	150	25							
TER/L 3232 P16	●	●	32	32	170	32	22 ER/EL	1720-U8-32x15	ATS-22E	ATS-22I	AAV-12-U8-32x5.5	ABPL-04	80-T20
TER/L 2525 M22	●	●	25	25	150	25							
TER/L 3232 P22	●	●	32	32	170	32							
TER/L 4040 S22	●	●	40	40	250	40	27 ER/EL	1620-M5x22	ATS-27E	ATS-27I	AAV-15-M5x5.7	ABPL-05	80-T20
TER/L 2525 M27	●	●	25	25	150	25							
TER/L 3232 P27	●	●	32	32	170	32							
TER/L 4040 S27	●	●	40	40	250	40							

R: Sağ / Right / Rechts L: Sol / Left / Links ● Stokta / In Stock / Auf Lager ○ Stokta Yok / Non Stock Item / Kein Lagerartikel, Lieferzeit auf Anfrage  
Takımlar standart 1.5° helis açılı olarak üretilir. / The tools have a built in 1.5° helix angle. / GEWINDE-DREHHALTER werden mit Einstellwinkel 1.5° hergestellt

Sipariş Örneği/Ordering Example/Bestellbeispiel  
1 ad./pcs./stück TER 1616 H16

DIŞ ÇAP SAĞ YÖNDE VİDA AÇMA  
EXTERNAL RIGHT HAND THREADING OPERATION  
HERSTELLUNG VON AUßEN-RECHTSGEWINDE

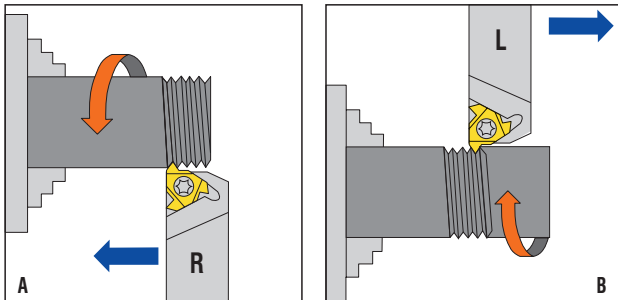

DIŞ ÇAP SOL YÖNDE VİDA AÇMA  
EXTERNAL LEFT HAND THREADING OPERATION  
HERSTELLUNG VON AUßEN-LINKSGEWİNDE

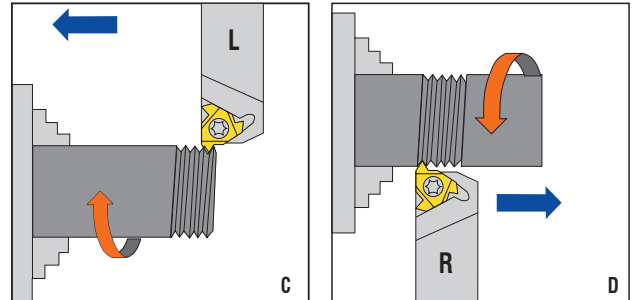

UYARI / WARNING / ACHTUNG

Figür B ve D için; negatif açılı altlık kullanılmalıdır. / For figure B and D; negative shim must be used. / Für Abbildung B und D; negative Unterlage verwenden.

Altiksız katederlerde B ve D figürü uygulanamaz. / B and D figures can not be applied on tools without shim. / Für Abbildung B und D; kann nicht mit Werkzeugen ohne Unterlegplatte erfolgen.



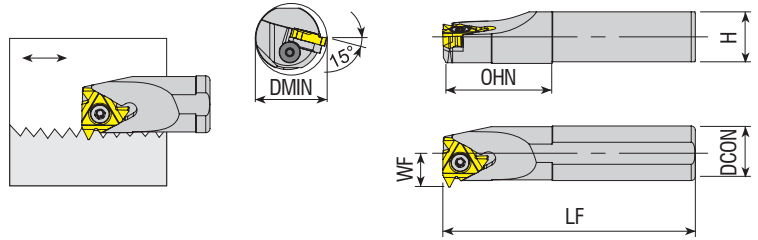

Takım Kodu Ordering Code Bestell-Bezeichnung	Stok Stock Lager		Takım Ölçüleri (mm) Dimension (mm) Abmessung (mm)					Kesici Uç Insert Wendeschneidplatte	Yedek Parçaları / Spare Parts / Ersatzteile						
	R	L	DCON	H	LF	OHN	WF		DMIN	Sıkma Vidası Screw Klemmschraube	Sol Aittik Left Shim U-Platte für WSP links	Sağ Aittik Right Shim U-Platte für WSP rechts	Aittik Vidası Shim Screw Schraube für Unterlage	Aittik Vidası Pulu Shim Screw Ring Schraube für Unterlagerung	Tork Anahtar Torx Key Torx Innensechskantschlüssel
TIR/L S25R 16	●	●	25	23	200	-	16.2	29	16 IR/L	1710-U5-40x12.2	ATS-16E	ATS-16I	AAV-11-U5-40x4.5	ABPL-03	82-T10
TIR/L S32S 16	●	●	32	30	250	-	19.7	36							
TIR/L S40T 16	●	●	40	37.5	300	-	23.7	44							
TIR/L S50U 16	●	●	50	47	350	-	28.7	54							
TIR/L S25R 22	●	●	25	23	200	-	18.1	29	22 IR/L	1720-U8-32x15	ATS-22E	ATS-22I	AAV-12-U8-32x5.5	ABPL-04	80-T20
TIR/L S32S 22	●	●	32	30	250	-	21.6	38							
TIR/L S40T 22	●	●	40	37.5	300	-	25.6	46							
TIR/L S50U 22	●	●	50	47	350	-	30.6	58							
TIR/L S32S 27	●	●	32	30	250	-	22.6	40	27 IR/L	1620-M5x18	ATS-27E	ATS-27I	AAV-15-M5x5.7	ABPL-05	80-T20
TIR/L S40T 27	●	●	40	37.5	300	-	26.6	48		1620-M5x22					
TIR/L S50U 27	●	●	50	47	350	-	31.6	58							
<b>new</b> TIR/L A20P 16	●	○	20	13.7	170	40	18	24	16 IR/L	1710-U5-40x12.2	ATS-16E	ATS-16I	AAV-11-U5-40x4.5	ABPL-03	82-T10
TIR/L A25R 16	○	●	25	23	200	50	16.2	29							
TIR/L A32S 16	○	●	32	30	250	60	19.7	36							
TIR/L A40T 16	○	●	40	37.5	300	65	23.9	44							

R: Sağ / Right / Rechts L: Sol / Left / Links ● Stokta / In Stock / Auf Lager ○ Stokta Yok / Non Stock Item / Kein Lagerartikel, Lieferzeit auf Anfrage  
Takımlar standart 1.5° helis açılı olarak üretilir. / The tools have a built in 1.5° helix angle. / GEWINDE-DREHHALTER werden mit Einstellwinkel 1.5° hergestellt

Sipariş Örneği/Ordering Example/Bestellbeispiel  
1 ad./pcs./stück TIR S25R 16

DELİK İÇİ SAĞ YÖNDE VİDA AÇMA  
INTERNAL RIGHT HAND THREADING OPERATION  
HERSTELLUNG VON INNEN-RECHTSGEWINDE

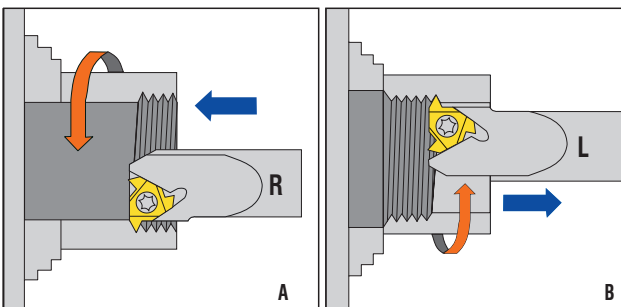

DELİK İÇİ SOL YÖNDE VİDA AÇMA  
INTERNAL LEFT HAND THREADING OPERATION  
HERSTELLUNG VON INNEN-LINKSGEWINDE

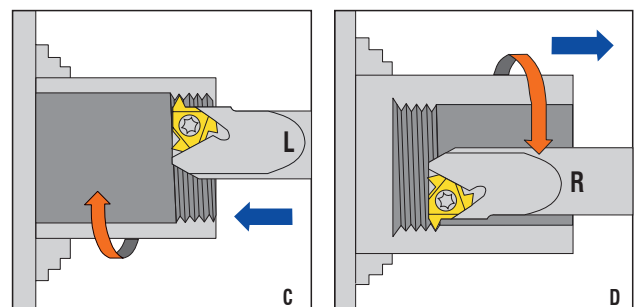

UYARI / WARNING / ACHTUNG

Figür B ve D için; negatif açılı aittik kullanılmalıdır. / For figure B and D; negative shim must be used. / Für Abbildung B und D; negative Unterlage verwenden.  
Aittiksiz katerlerde B ve D figürü uygulanamaz. / B and D figures can not be applied on tools without shim. / Für Abbildung B und D; kann nicht mit Werkzeugen ohne Unterlegplatte erfolgen.

## Diş Helis Açısı Thread Helix Angle Steigungswinkel

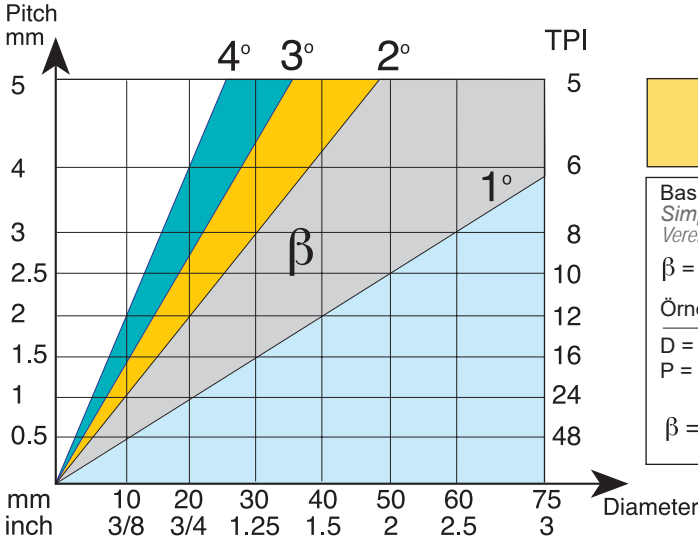

$$\tan \beta = \frac{P}{\pi \times D}$$

Basitleştirilmiş formül  
 Simplified formula  
 Vereinfachte Formel

$$\beta = 20 P/D$$

Örnek / Example / Beispiel :

$$D = 25 \text{ mm (0.98")}$$

$$P = 1.5 \text{ mm (16 TPI)}$$

$$\beta = \frac{20 \times 1.5}{25} = 1.2^\circ$$

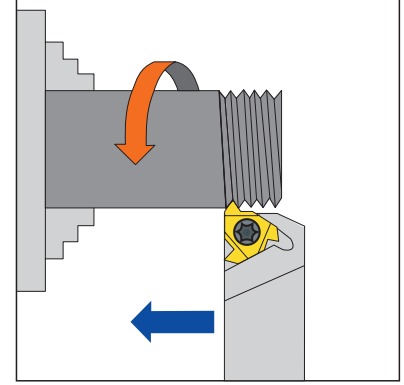

## Standart ve Eğik Altlıklar Standard and Slanted Shim Standard und Schräge Unterlegplatte

Akko diş açma takımlarının, uç yuvaları 1.5° helis açılı olarak üretilir. Farklı helis açılı diş açmak isteyenler altlığı değiştirerek istedikleri dereceyi elde edebilirler. Negatif helis genellikle sol katerde sağ diş çekmek için kullanılır ya da sağ katerde sol diş çekmek için kullanılır.

Akko Toolholders Pockets have a built in 1.5° helix angle. This angle may be adjusted to better match the thread helix angle by simply changing the shim. Negative helix is usually used when threading RH thread with LH Holder or LH thread with RH Holder.

Die Akko-Gewindedrehhalter werden mit 1,5°-Steigungswinkel produziert. Durch Wechseln der Unterlage kann dieser Winkel dem optimalen Steigungswinkel angepasst werden. Die Unterlagen mit negativem Winkel werden eingesetzt, wenn ein Rechtsgewinde mit einem linken Halter oder ein Linksgewinde mit einem rechten Halter gefertigt werden soll.

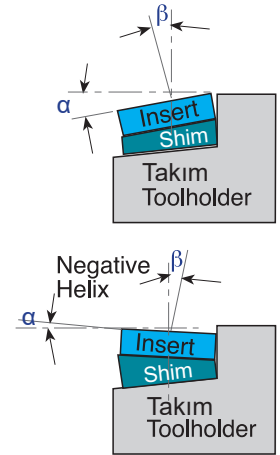

L	IC	Takım Tipi Tool Type Werkzeugtyp	Uç Yuvasının Açısı (α) / Pocket's Angle (α) / Winkel Wendeplattensitz (α)						
			4.5°	3.5°	2.5°	1.5°	0.5°	-0.5°	-1.5°
16	3/8	EX-RH or IN-LH	ATS-16E+4.5	ATS-16E+3.5	ATS-16E+2.5	ATS-16E	ATS-16E+0.5	ATS-16E-0.5	ATS-16E-1.5
16	3/8	EX-LH or IN-RH	ATS-16I+4.5	ATS-16I+3.5	ATS-16I+2.5	ATS-16I	ATS-16I+0.5	ATS-16I-0.5	ATS-16I-1.5
22	1/2	EX-RH or IN-LH	ATS-22E+4.5	ATS-22E+3.5	ATS-22E+2.5	ATS-22E	ATS-22E+0.5	ATS-22E-0.5	ATS-22E-1.5
22	1/2	EX-LH or IN-RH	ATS-22I+4.5	ATS-22I+3.5	ATS-22I+2.5	ATS-22I	ATS-22I+0.5	ATS-22I-0.5	ATS-22I-1.5
27	5/8	EX-RH or IN-LH	ATS-27E+4.5	ATS-27E+3.5	ATS-27E+2.5	ATS-27E	ATS-27E+0.5	ATS-27E-0.5	ATS-27E-1.5
27	5/8	EX-LH or IN-RH	ATS-27I+4.5	ATS-27I+3.5	ATS-27I+2.5	ATS-27I	ATS-27I+0.5	ATS-27I-0.5	ATS-27I-1.5

## Altlık Değişirme Öneri Tablosu / Shim Change Recommendation Empfehlungen zum Wechseln der Unterlage

Tabloda da görüldüğü gibi bazı diş hatvelerinin çaplara göre kombinasyonları altlık değişimini gerektirir. Eğer değişim gerekli ise EX-RH ve IN-LH katerleri için ATS-E altlıklarını, IN-RH ve EX-LH katerleri için ATS-I altlıklarını kullanın.

As can be seen from the chart, some Pitch to Diameter combinations require a shim change. If change is required, use ATS-E shim for EX-RH and IN-LH toolholders and ATS-I shims for IN-RH and EX-LH toolholders.

Wie aus der Tabelle ersichtlich, erfordern einige Steigung-Durchmesser-Kombinationen einen Wechsel der Unterlage. In diesem Fall wird eine ATS-E-Unterlage auf einem rechten Außenhalter bzw. einem linken Innenhalter eingesetzt. Die ATS-I-Unterlage kommt bei einem rechten Innenhalter bzw. einem linken Außenhalter zum Einsatz.

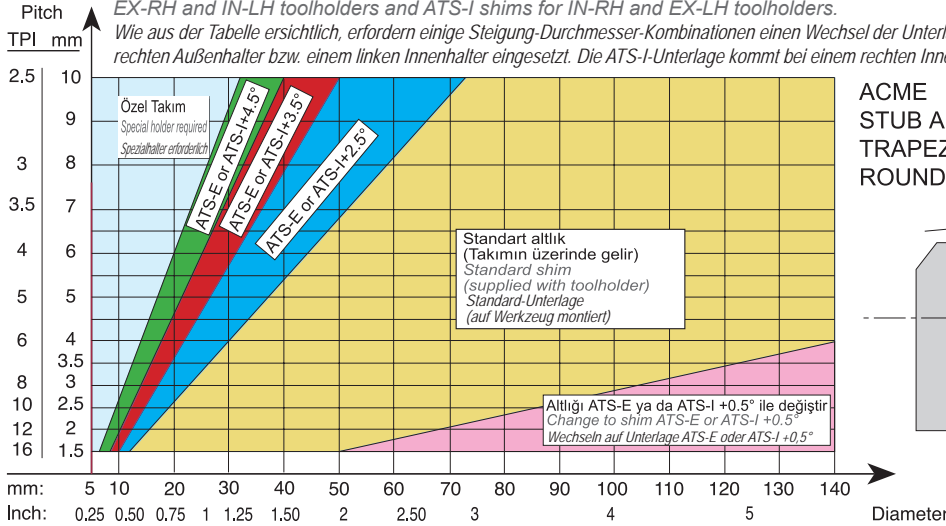

ACME  
 STUB ACME  
 TRAPEZ (DIN 103)  
 ROUND (DIN 405)

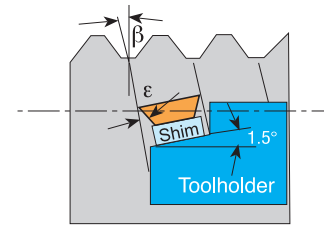

Tabloda da görüldüğü gibi çoğu uygulamalar altlık değişimine ihtiyaç duymaz. Eğer değişime ihtiyaç duyulursa EX-RH ve IN-LH katerleri için ATS-E altlıklarını, IN-RH ve EX-RH katerleri için ATS-I altlıklarını kullanın.

As can be seen from the chart, most applications do not require a shim change. If change is required, use ATS-E shims for EX-RH and IN-LH toolholders and ATS-I shims for IN-RH and EX-LH toolholders.

Wie aus der Tabelle ersichtlich, erfordern einige Steigung-Durchmesser-Kombinationen einen Wechsel der Unterlage. In diesem Fall wird eine ATS-E-Unterlage auf einem rechten Außenhalter bzw. einem linken Innenhalter eingesetzt. Die ATS-I-Unterlage kommt bei einem rechten Innenhalter bzw. einem linken Außenhalter zum Einsatz.

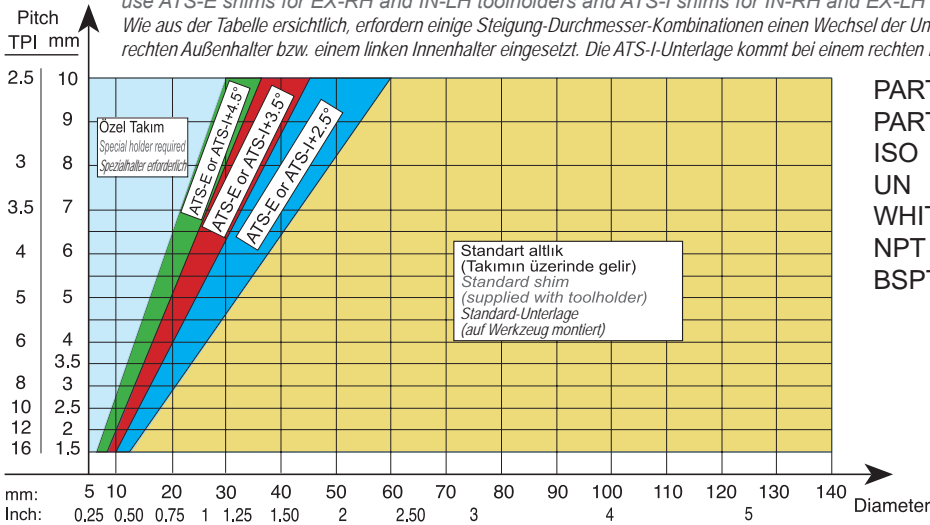

PARTIAL PROFILES 60°  
 PARTIAL PROFILES 55°  
 ISO  
 UN  
 WHIT.  
 NPT  
 BSPT

Tabloda da görüldüğü gibi çoğu uygulamalar altlık değişimine ihtiyaç duyar. Çoğu durumda negatif bir altlığı ihtiyaç duyulur. EX-RH ve IN-LH takımlar için ATS-E altlıklarını kullanın. IN-RH ve EX-LH takımlar için ATS-I altlıklarını kullanın.

As can be seen from the chart, most applications require a shim change. In most cases a negative shim is required, use ATS-E shims for EX-RH and IN-LH toolholders. ATS-I shims for IN-RH and EX-LH toolholders.

Wie aus der Tabelle ersichtlich, erfordern einige Steigung-Durchmesser-Kombinationen einen Wechsel der Unterlage. In diesem Fall wird eine ATS-E-Unterlage auf einem rechten Außenhalter bzw. einem linken Innenhalter eingesetzt. Die ATS-I-Unterlage kommt bei einem rechten Innenhalter bzw. einem linken Außenhalter zum Einsatz.

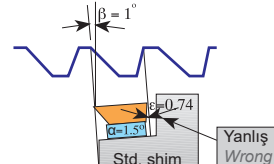
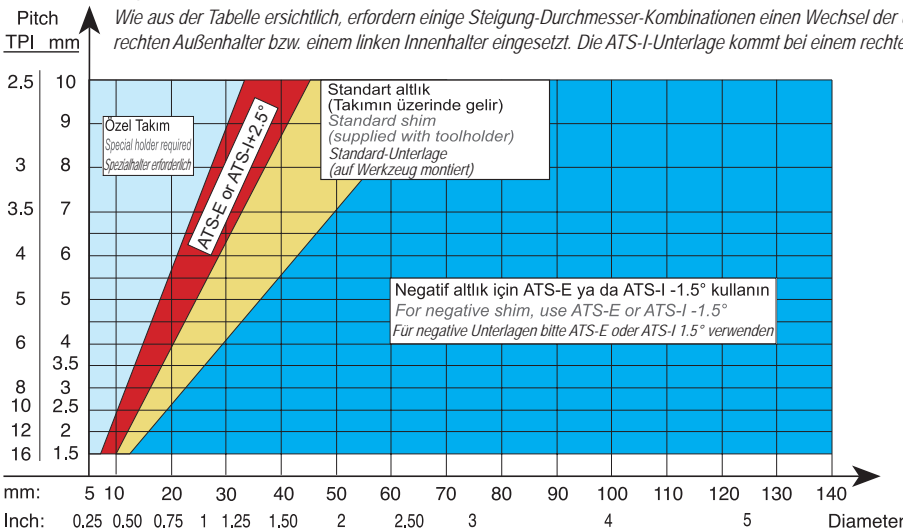

Before Shim Change  
 Altlığı Değiştirmeden Önce  
 До смены опорной пластины

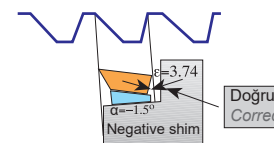

After Shim Change  
 Altlığı Değiştirdikten Sonra  
 Nach dem Wechsel der Unterlegplatte

AMERICAN  
 BUTTRESS  
 SAGENGEWINDE  
 (DIN 513)

Standart altlığın negatif bir altlıkla değiştirilmesi, kenar sürtmesini engelleyecektir.

Replacing the standard shim with a shim has negative angle, will eliminate side rubbing

Das Ersetzen der Standard-Unterlegplatte durch eine Unterlegplatte mit negativem Winkel verhindert seitliche Reibung.



*konusulan  
the spoken kalite...  
quality...*

# KANAL AÇMA

KANAL AÇMA TAKIMLARI  
GROOVING TOOLHOLDERS  
STECHHALTER



AKKO **A** **AKT** - **K** - **R** - **2525**

**100 - 150** - **4** - **T22**

**2** Kesici Stili / Cutter Style / Cutter-Stil

DKT: Dış Çap Kanal Açma Takımı / External Grooving Toolholders  
Außen-Steckhalter  
IKT: Delik İçi Kanal Açma Takımı / Internal Grooving Toolholders  
Innen-Steckhalter  
AKT: Dış Çap Alın Kanal Takımları / Face Grooving Toolholders  
Axial-Steckhalter  
LKT: L Tip Alın Kanal Açma Takımı / L Type Face Grooving Toolholders  
Axial-Steckhalter L-Type

**3** Uç Tipi / Insert Type / Plattenform

KRLY / MGM.  
HRN / S312, S229, S224, S223  
ISCR / DGN, GI, GTN  
SNDVK / 123, 151, 154.91  
ZCC  
KM / A4.  
ARN / LOMR.

TGTC / TD.

**4** Kesme Yönü / Cutting Direction  
Halteausführung

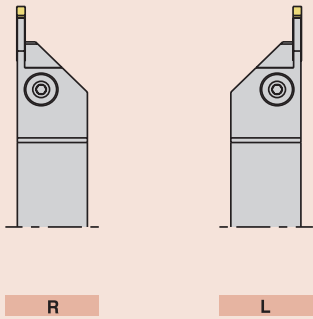

**5** Kesme Kenar Yüksekliği ve Şaft Genişliği  
Cutting Edge Height and Shank Width  
Schafthöhe und Schafbreite

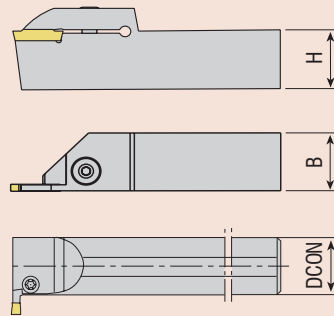

**6** Kesme Aralığı  
Cutting Diameter  
Durchmesser für Axialeinstechen

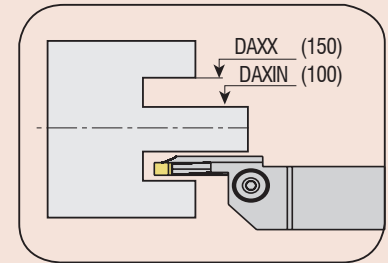

**7** Kesme Kenar Genişliği / Cutting Width Edge  
Plattenbreite

ÖR/E.G :  
2 = 2.0 mm  
3 = 3.0 mm  
4 = 4.0 mm  
5 = 5.0 mm  
6 = 6.0 mm  
8 = 8.0 mm



**8** Kesme Derinliği / Cutting Depth / Maximale Schnitttiefe

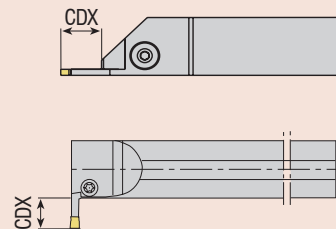

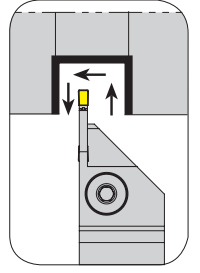
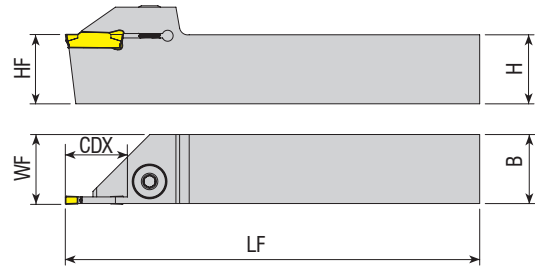

Takım Kodu Ordering Code Bestell-Bezeichnung	Stok Stock Lager		Takım Ölçüleri (mm) Dimension (mm) Abmessung (mm)				Kesici Uç Insert Wendeschneidplatte	Yedek Parçaları / Spare Parts / Ersatzteile			
	R	L	HF=H	B	LF	WF		CDX	Sıkma Vidası Screw Klemmschraube	Pul Stamp Ring	Anahtar Allen Key Innensechskantschlüssel
ADKT-K-R/L-1212-1.5-T15	●	●	12	12	100	12.2	15	MGM. - 1.5	AKV-02-M6x22	ABPL-01	AAL-03-3
ADKT-K-R/L-2020-1.5-T15	●	●	20	20	125	20.2	15				
ADKT-K-R/L-1212-2-T15	●	●	12	12	100	16.3	15				
ADKT-K-R/L-1616-2-T10	●	●	16	16	125	16.3	10				
ADKT-K-R/L-1616-2-T15	●	●	16	16	125	16.3	15				
ADKT-K-R/L-2020-2-T15	●	●	20	20	150	20.3	15				
ADKT-K-R/L-2525-2-T15	●	●	25	25	150	25.3	15				
ADKT-K-R/L-3232-2-T15	●	●	32	32	170	32.3	15				
ADKT-K-R/L-1212-3-T15	●	●	12	12	100	12.3	15				
ADKT-K-R/L-1616-3-T15	●	●	16	16	125	16.3	15				
ADKT-K-R/L-2020-3-T10	●	●	20	20	125	20.3	10				
ADKT-K-R/L-2020-3-T20	●	●	20	20	125	20.3	20				
ADKT-K-R/L-2020-3-R28	●	●	20	20	125	20.3	28				
ADKT-K-R/L-2525-3-T10	●	●	25	25	150	25.3	10				
ADKT-K-R/L-2525-3-R15	●	●	25	25	150	25.3	15				
ADKT-K-R/L-2525-3-T22	●	●	25	25	150	25.3	22				
ADKT-K-R/L-3232-3-T10	●	●	32	32	170	32.3	10				
ADKT-K-R/L-3232-3-T22	●	●	32	32	170	32.3	22				
ADKT-K-R/L-2020-4-T10	●	●	20	20	125	20.4	10				
ADKT-K-R/L-2020-4-T20	●	●	20	20	125	20.4	20				
ADKT-K-R/L-2020-4-R25	●	○	20	20	125	20.4	25				
ADKT-K-R/L-2525-4-T10	●	●	25	25	150	25.4	10				
ADKT-K-R/L-2525-4-T18	●	●	25	25	150	25.4	18				
ADKT-K-R/L-2525-4-T22	●	●	25	25	150	25.4	22				
ADKT-K-R/L-3232-4-T10	●	●	32	32	170	32.4	10				
ADKT-K-R/L-3232-4-T22	●	●	32	32	170	32.4	22				
ADKT-K-R/L-2020-5-T20	●	●	20	20	125	20.5	20				
ADKT-K-R/L-2525-5-T15	●	●	25	25	150	25.5	15				
ADKT-K-R/L-2525-5-T18	●	●	25	25	150	25.5	18				
ADKT-K-R/L-2525-5-T25	●	●	25	25	150	25.5	25				
ADKT-K-R/L-3232-5-T15	●	●	32	32	170	32.5	15				
ADKT-K-R/L-3232-5-T25	●	●	32	32	170	32.5	25				
ADKT-K-R/L-2525-6-T15	●	●	25	25	150	25.6	15				
ADKT-K-R/L-2525-6-T25	●	●	25	25	150	25.6	25				
ADKT-K-R/L-3232-6-T25	●	●	32	32	170	32.6	25				
ADKT-K-R/L-3232-8-T32	●	●	32	32	170	32.8	32				
								MGM. - 4	2004-M8x1x20	-	AAL-05-4
								MGM. - 5			
								MGM. - 6			
								MGM. - 8			

R: Sağ / Right / Rechts L: Sol / Left / Links

● Stokta / In Stock / Auf Lager ○ Stokta Yok / Non Stock Item / Kein Lagerartikel, Lieferzeit auf Anfrage

KRLY - JD Ucuna Uygunudur. / Compatible with KRLY - JD Insert. / Kompatibel mit KRLY - JD Wendeleplatten.

Sipariş Örneği/Ordering Example/Bestellbeispiel

1 ad./pcs./stück ADKT-K-R-1212-1.5-T15

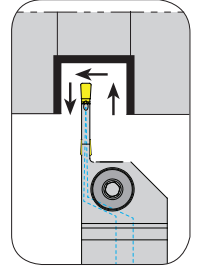
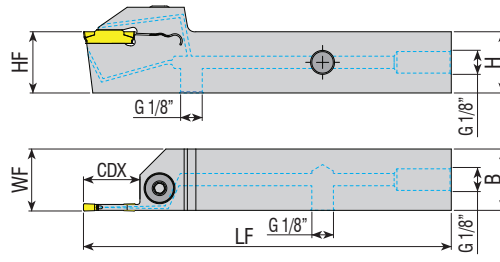
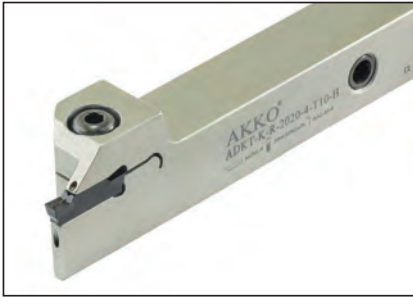

**Takım Kodu**  
**Ordering Code**  
**Bestell-Bezeichnung**

Stok Stock Lager	Takım Ölçüleri (mm) Dimension (mm) Abmessung (mm)						Kesici Uç Insert Wendeschneidplatte	Yedek Parçaları / Spare Parts / Ersatzteile			
	R	L	HF=H	B	LF	WF		CDX	Sıkma Vidası Screw Klemmschraube	Pul Stamp Ring	Anahtar Allen Key Innensechskantschlüssel
ADKT-K-R/L-2020-3-T20-H	●	●	20	20	125	20.4	20	MGM. - 3	2004-M8x1x20	-	AAL-05-4
ADKT-K-R/L-2525-3-T22-H	●	●	25	25	150	25.4	22				
ADKT-K-R/L-2020-4-T20-H	●	●	20	20	125	20.4	20				
ADKT-K-R/L-2525-4-T22-H	●	●	25	25	150	25.4	22				
ADKT-K-R/L-2525-5-T25-H	●	●	25	25	150	25.5	25				

KRRLY Ucuna Uygun. / Compatible with KRRLY Insert. / Kompatibel mit KRRLY Wendeplatten.

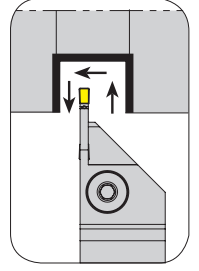
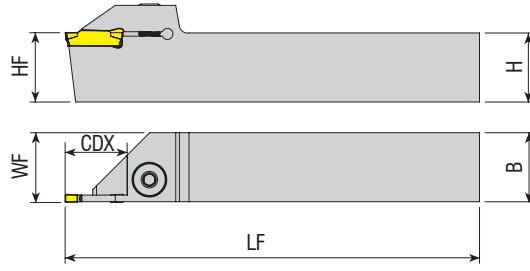

**Takım Kodu**  
**Ordering Code**  
**Bestell-Bezeichnung**

Stok Stock Lager	Takım Ölçüleri (mm) Dimension (mm) Abmessung (mm)						Kesici Uç Insert Wendeschneidplatte	Yedek Parçaları / Spare Parts / Ersatzteile						
	R	L	HF=H	B	LF	WF		CDX	Sıkma Vidası Screw Klemmschraube	Pul Stamp Ring	Anahtar Allen Key Innensechskantschlüssel			
ADKT-KG-R/L-2020-2-T15	●	●	20	20	125	20.2	15	KG.. - 2	AKV-02-M6x22	ABPL-01	AAL-03-3			
ADKT-KG-R/L-2525-2-T8	●	●	25	25	150	25.2	8							
ADKT-KG-R/L-2525-2-T15	●	○	25	25	150	25.2	15							
ADKT-KG-R/L-2525-2-T17	●	○	25	25	150	25.2	17							
ADKT-KG-R/L-1616-3-T20	●	●	16	16	125	16.3	20							
ADKT-KG-R/L-2020-3-T20	●	●	20	20	125	20.3	20	KG.. - 3	2004-M8x1x20	-	AAL-05-4			
ADKT-KG-R/L-2525-3-T10	●	●	25	25	150	25.3	10							
ADKT-KG-R/L-2525-3-T13	●	●	25	25	150	25.3	13							
ADKT-KG-R/L-2525-3-T22	●	●	25	25	150	25.3	22							
ADKT-KG-R/L-2020-4-T20	●	●	20	20	125	20.4	20	KG.. - 4				2004-M8x1x20	-	AAL-05-4
ADKT-KG-R/L-2525-4-T10	●	●	25	25	150	25.4	10							
ADKT-KG-R/L-2525-4-T16	●	○	25	25	150	25.4	16							
ADKT-KG-R/L-2525-4-T22	●	○	25	25	150	25.4	22							
ADKT-KG-R/L-2525-5-T12	●	●	25	25	150	25.5	12	KG.. - 5	2004-M8x1x20	-	AAL-05-4			
ADKT-KG-R/L-2525-5-T15	●	●	25	25	150	25.5	15							
ADKT-KG-R/L-2525-5-T25	●	○	25	25	150	25.5	25							
ADKT-KG-R/L-2525-6-T25	○	○	25	25	150	25.6	25	KG.. - 6				2004-M8x1x20	-	AAL-05-4

R: Sağ / Right / Rechts L: Sol / Left / Links

● Stokta / In Stock / Auf Lager ○ Stokta Yok / Non Stock Item / Kein Lagerartikel, Lieferzeit auf Anfrage  
KRRLY Ucuna Uygun. / Compatible with KRRLY Insert. / Kompatibel mit KRRLY Wendeplatten.

Sipariş Örneği/Ordering Example/Bestellbeispiel

1 ad./pcs./stück ADKT-K-R-2020-3-T20-H

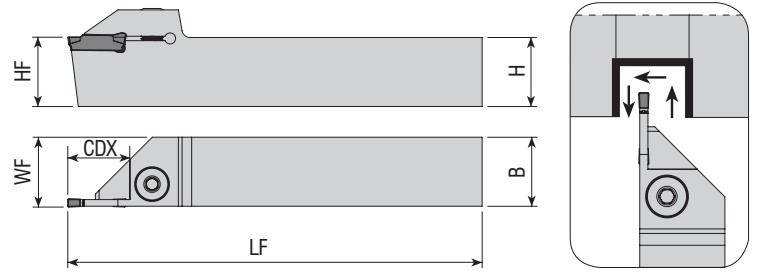

Takım Kodu Ordering Code Bestell-Bezeichnung	Stok Stock Lager		Takım Ölçüleri (mm) Dimension (mm) Abmessung (mm)					Kesici Uç Insert Wendeschneidplatte	Yedek Parçaları / Spare Parts / Ersatzteile			
	R	L	HF=H	B	LF	WF	CDX		Sıkma Vidası Screw Klemmschraube	Pul Stamp Ring	Anahtar Allen Key Innensechskantschlüssel	
ADKT-SGC-R/L-1212-2-R15	●	●	12	12	100	16.2	15	GCM N20	AKV-02-M6x22	ABPL-01	AAL-03-3	
ADKT-SGC-R/L-1616-2-R15	●	●	16	16	125	16.2	15					
ADKT-SGC-R/L-2020-2-R20	●	●	20	20	125	20.2	20					
ADKT-SGC-R/L-2525-2-R20	●	●	25	25	150	25.2	20	GCM N30	2004-M8x1x20	-	AAL-05-4	
ADKT-SGC-R/L-1212-3-R15	●	●	12	12	100	16.3	15					
ADKT-SGC-R/L-1616-3-T12	●	○	16	16	125	16.3	12					
ADKT-SGC-R/L-1616-3-R15	●	●	16	16	125	16.3	15	GCM N40	2004-M8x1x20	-	AAL-05-4	
ADKT-SGC-R/L-2020-3-R22	●	●	20	20	125	20.3	22					
ADKT-SGC-R/L-2525-3-R15	●	○	25	25	150	25.3	15					
ADKT-SGC-R/L-2525-3-R22	●	●	25	25	150	25.3	22	GCM N40	2004-M8x1x20	-	AAL-05-4	
ADKT-SGC-R/L-2525-4-R25	●	○	25	25	150	25.4	25					

SMTM Ucuna Uygun. / Compatible with SMTM Insert. / Kompatibel mit SMTM

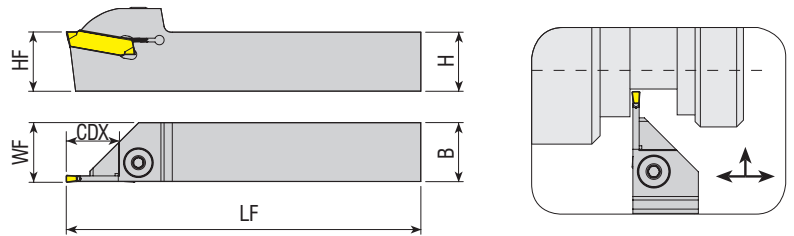

Takım Kodu Ordering Code Bestell-Bezeichnung	Stok Stock Lager		Takım Ölçüleri (mm) Dimension (mm) Abmessung (mm)					Kesici Uç Insert Wendeschneidplatte	Yedek Parçaları / Spare Parts / Ersatzteile			
	R	L	HF=H	B	LF	WF	CDX		Sıkma Vidası Screw Klemmschraube	Pul Stamp Ring	Anahtar Allen Key Innensechskantschlüssel	
ADKT-H-R/L-2020-3-T20	●	●	20	20	125	20.5	20	S229 - 3	2004-M8x1x20	-	AAL-05-4	
ADKT-H-R/L-2525-3-T22	●	●	25	25	150	25.5	22					
ADKT-H-R/L-2525-3-T26	●	●	25	25	150	25.5	26					
ADKT-H-R/L-2020-4-T20	●	●	20	20	125	20.5	20	S229 - 4	2004-M8x1x20	-	AAL-05-4	
ADKT-H-R/L-2525-4-T22	●	●	25	25	150	25.5	22					
ADKT-H-R/L-3232-4-T22	●	●	32	32	170	32.5	22					
ADKT-H-R/L-2020-5-T20	●	●	20	20	125	20.5	20	S229 - 5	2004-M8x1x20	-	AAL-05-4	
ADKT-H-R/L-2525-5-T25	●	●	25	25	150	25.5	25					
ADKT-H-R/L-2525-6-T25	●	●	25	25	150	25.6	25	S229 - 6	2004-M8x1x20	-	AAL-05-4	

R: Sağ / Right / Rechts L: Sol / Left / Links

● Stokta / In Stock / Auf Lager ○ Stokta Yok / Non Stock Item / Kein Lagerartikel, Lieferzeit auf Anfrage  
HRN Ucuna Uygun. / Compatible with HRN Insert. / Kompatibel mit HRN Wendeplatten.

Sipariş Örneği/Ordering Example/Bestellbeispiel  
1 ad./pcs./stück ADKT-SGC-R-1212-2-R15



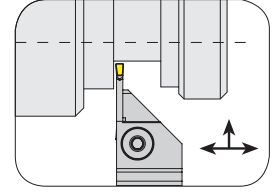
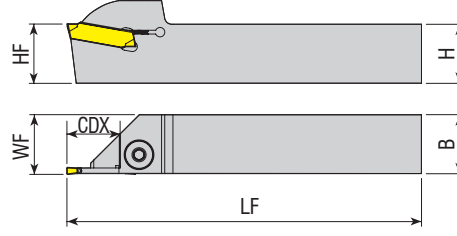

Takım Kodu Ordering Code Bestell-Bezeichnung	Stok Stock Lager		Takım Ölçüleri (mm) Dimension (mm) Abmessung (mm)				Kesici Uç Insert Wendeschneidplatte	Yedek Parçaları / Spare Parts / Ersatzteile			
	R	L	HF=H	B	LF	WF		CDX	Sıkma Vidası Screw Klemmschraube	Pul Stamp Ring	Anahtar Allen Key Innensechskantschlüssel
ADKT-HK-R/L-1616-2-T15	●	●	16	16	125	16.3	15	S224 - 2	AKV-02-M6x22	ABPL-01	AAL-03-3
ADKT-HK-R/L-2020-2-T15	●	●	20	20	125	20.3	15				
ADKT-HK-R/L-2525-2-T15	●	●	25	25	150	25.3	15				
ADKT-HK-R/L-1616-3-T15	○	○	16	16	125	16.3	15	S224 - 3	2004-M8x1x20	-	AAL-05-4
ADKT-HK-R/L-2020-3-T20	●	●	20	20	125	20.4	20				
ADKT-HK-R/L-2525-3-T22	●	●	25	25	150	25.4	22				
ADKT-HK-R/L-2020-4-T20	●	●	20	20	125	20.4	20				
ADKT-HK-R/L-2525-4-T22	●	●	25	25	150	25.4	22	S224 - 4			
ADKT-HS223-R/L-2020-2-T15	●	○	20	20	125	20.4	15	S223 - 2	AKV-02-M6x22	ABPL-01	AAL-03-3
ADKT-HS223-R/L-2020-3-T17	●	○	20	20	125	20.3	17	S223 - 3	2004-M8x1x20	-	AAL-05-4

HRN Ucuna Uygunudur. / Compatible with HRN Insert. / Kompatibel mit HRN Wendepplatten.

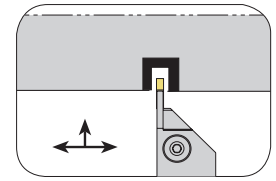
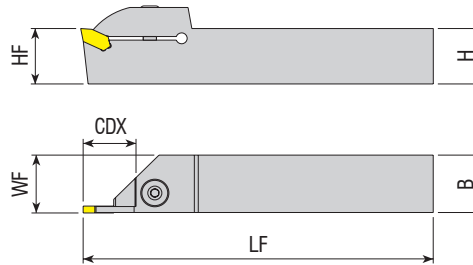

Takım Kodu Ordering Code Bestell-Bezeichnung	Stok Stock Lager		Takım Ölçüleri (mm) Dimension (mm) Abmessung (mm)				Kesici Uç Insert Wendeschneidplatte	Yedek Parçaları / Spare Parts / Ersatzteile			
	R	L	HF=H	B	LF	WF		CDX	Sıkma Vidası Screw Klemmschraube	Pul Stamp Ring	Anahtar Allen Key Innensechskantschlüssel
ADKT-ZCC1-R/L-2020-3-T20	●	○	20	20	125	20.3	20	ZQMX - 3	2004-M8x1x20	-	AAL-05-4
ADKT-ZCC1-R/L-2525-3-T22	●	○	25	25	150	25.3	22				
ADKT-ZCC1-R/L-2020-4-T20	●	○	20	20	125	20.4	20	ZQMX - 4			
ADKT-ZCC1-R/L-2525-4-T22	●	○	25	25	150	25.4	22				

R: Sağ / Right / Rechts L: Sol / Left / Links  
● Stokta / In Stock / Auf Lager ○ Stokta Yok / Non Stock Item / Kein Lagerartikel, Lieferzeit auf Anfrage  
ZCC Ucuna Uygunudur. / Compatible with ZCC Insert. / Kompatibel mit ZCC Wendepplatten.

Sipariş Örneği/Ordering Example/Bestellbeispiel  
1 ad./pcs./stück ADKT-HK-R-1616-2-T15

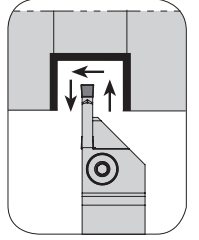
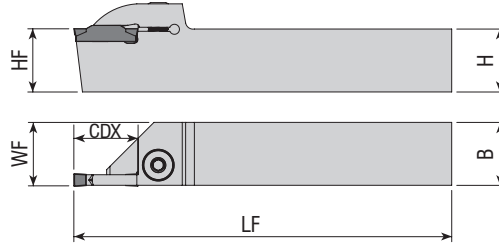

Takım Kodu Ordering Code Bestell-Bezeichnung	Stok Stock Lager		Takım Ölçüleri (mm) Dimension (mm) Abmessung (mm)					Kesici Uç Insert Wendeschneidplatte	Yedek Parçaları / Spare Parts / Ersatzteile		
	R	L	HF=H	B	LF	WF	CDX		Sıkma Vidası Screw Klemmschraube	Pul Stamp Ring	Anahtar Allen Key Innensechskantschlüssel
ADKT-ZCC2-R/L-1616-2-T15	●	●	16	16	125	16.2	15	Z.BD - 2	AKV-02-M6x22	ABPL-01	AAL-03-3
ADKT-ZCC2-R/L-2020-2-T7	●	●	20	20	125	20.2	7				
ADKT-ZCC2-R/L-2020-2-T15	●	●	20	20	125	20.2	15				
ADKT-ZCC2-R/L-2525-2-T15	●	●	25	25	150	25.2	15	Z.ED - 2.5			
ADKT-ZCC2-R/L-1616-2.5-T15	●	●	16	16	125	16.3	15				
ADKT-ZCC2-R/L-2020-2.5-T17	●	●	20	20	125	20.3	17				
ADKT-ZCC2-R/L-2525-2.5-T15	●	●	25	25	150	25.3	15	Z.FD - 3			
ADKT-ZCC2-R/L-1616-3-T15	●	●	16	16	125	16.3	15				
ADKT-ZCC2-R/L-1616-3-T17	●	○	16	16	125	16.3	17				
ADKT-ZCC2-R/L-1616-3-T20	●	○	16	16	125	16.3	20	Z.GD - 4	2004-M8x1x20	-	AAL-05-4
ADKT-ZCC2-R/L-2020-3-T12	●	●	20	20	125	20.3	12				
ADKT-ZCC2-R/L-2020-3-T20	●	●	20	20	125	20.3	20				
ADKT-ZCC2-R/L-2020-3-R21	●	○	20	20	125	20.3	21	Z.HD - 5			
ADKT-ZCC2-R/L-2020-3-R25	●	●	20	20	125	20.3	25				
ADKT-ZCC2-R/L-2525-3-T12	●	○	25	25	150	25.3	12				
ADKT-ZCC2-R/L-2525-3-T22	●	●	25	25	150	25.3	22	Z.KD - 6			
ADKT-ZCC2-R/L-2525-3-R30	●	●	25	25	150	25.3	30				
ADKT-ZCC2-R/L-2020-4-T12	●	○	20	20	125	20.5	12				
ADKT-ZCC2-R/L-2020-4-T20	●	●	20	20	125	20.5	20	Z.HD - 5			
ADKT-ZCC2-R/L-2525-4-T12	●	●	25	25	150	25.5	12				
ADKT-ZCC2-R/L-2525-4-T22	●	●	25	25	150	25.5	22				
ADKT-ZCC2-R/L-2020-5-T12	●	○	20	20	125	20.5	12	Z.KD - 6			
ADKT-ZCC2-R/L-2020-5-T20	●	●	20	20	125	20.5	20				
ADKT-ZCC2-R/L-2525-5-T12	●	○	25	25	150	25.5	12				
ADKT-ZCC2-R/L-2525-5-T25	●	●	25	25	150	25.5	25	Z.KD - 6			
ADKT-ZCC2-R/L-3232-5-T25	●	●	32	32	170	32.5	25				
ADKT-ZCC2-R/L-2020-6-T20	●	●	20	20	125	20.6	20				
ADKT-ZCC2-R/L-2525-6-T25	●	●	25	25	150	25.6	25	Z.KD - 6			
ADKT-ZCC2-R/L-3232-6-T25	●	●	32	32	170	32.6	25				
ADKT-ZCC2-R/L-3232-6-T30	●	●	32	32	170	32.6	30				

R: Sağ / Right / Rechts L: Sol / Left / Links

● Stokta / In Stock / Auf Lager ○ Stokta Yok / Non Stock Item / Kein Lagerartikel, Lieferzeit auf Anfrage  
ZCC Ucuna Uygundur. / Compatible with ZCC Insert. / Kompatibel mit ZCC Wendeplatten.

Sipariş Örneği/Ordering Example/Bestellbeispiel  
1 ad./pcs./stück ADKT-ZCC2-R-1616-2-T15

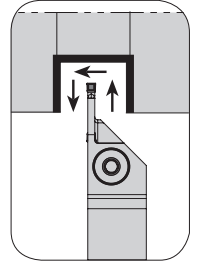
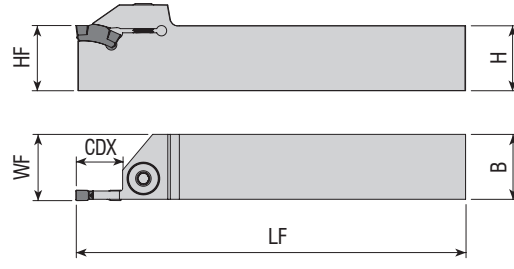

Takım Kodu Ordering Code Bestell-Bezeichnung	Stok Stock Lager		Takım Ölçüleri (mm) Dimension (mm) Abmessung (mm)					Kesici Uç Insert Wendeschneidplatte	Yedek Parçaları / Spare Parts / Ersatzteile		
	R	L	HF=H	B	LF	WF	CDX		Sıkma Vidası Screw Klemmschraube	Pul Stamp Ring	Anahtar Allen Key Innensechskantschlüssel
ADKT-ITG-R/L-2020-3-T8	●	●	20	20	125	20.3	8	TGM. - 3	2004-M8x1x20	-	AAL-05-4
ADKT-ITG-R/L-2525-3-T8	●	●	25	25	150	25.3	8				
ADKT-ITG-R/L-3232-3-T8	●	○	32	32	170	32.3	8				
ADKT-ITG-R/L-2020-4-T9	●	●	20	20	125	20.4	9	TGM. - 4	2004-M8x1x20	-	AAL-05-4
ADKT-ITG-R/L-2525-4-T17	●	●	25	25	150	25.4	17				
ADKT-ITG-R/L-3232-4-T17	●	●	32	32	170	32.4	17				
ADKT-ITG-R/L-3232-5-T25	●	○	32	32	170	32.5	25	TGM. - 5			

ISCR Ucuna Uygundur. / Compatible with ISCR Insert. / Kompatibel mit ISCR.

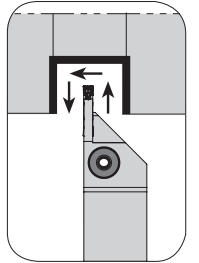
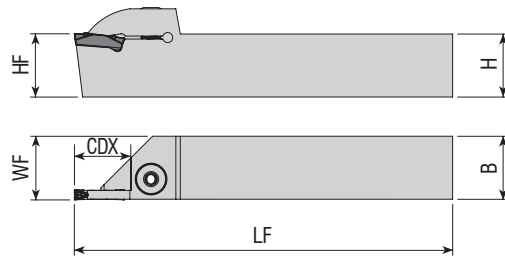
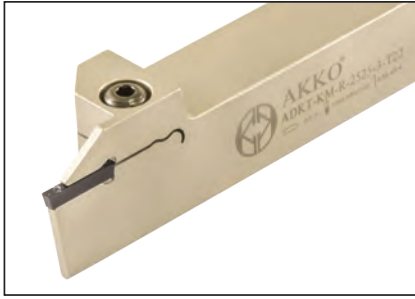

Takım Kodu Ordering Code Bestell-Bezeichnung	Stok Stock Lager		Takım Ölçüleri (mm) Dimension (mm) Abmessung (mm)					Kesici Uç Insert Wendeschneidplatte	Yedek Parçaları / Spare Parts / Ersatzteile		
	R	L	HF=H	B	LF	WF	CDX		Sıkma Vidası Screw Klemmschraube	Pul Stamp Ring	Anahtar Allen Key Innensechskantschlüssel
ADKT-KM-R/L-2020-2-T15	●	●	20	20	125	20.3	15	A4. - 2	AKV-02-M6x22	ABPL-01	AAL-03-3
ADKT-KM-R/L-2525-2-T15	●	●	25	25	150	25.3	15				
ADKT-KM-R/L-2020-3-T20	●	●	20	20	125	20.4	20	A4. - 3	2004-M8x1x20	-	AAL-05-4
ADKT-KM-R/L-2525-3-T22	●	●	25	25	150	25.4	22				
ADKT-KM-R/L-2525-4-T22	●	●	25	25	150	25.5	22				

R: Sağ / Right / Rechts L: Sol / Left / Links  
● Stokta / In Stock / Auf Lager ○ Stokta Yok / Non Stock Item / Kein Lagerartikel, Lieferzeit auf Anfrage  
KNMTL Ucuna Uygundur. / Compatible with KNMTL Insert. / Kompatibel mit KNMTL Wendeplatten.

Sipariş Örneği/Ordering Example/Bestellbeispiel  
1 ad./pcs./stück ADKT-ITG-R-2020-3-T8

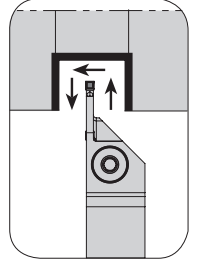
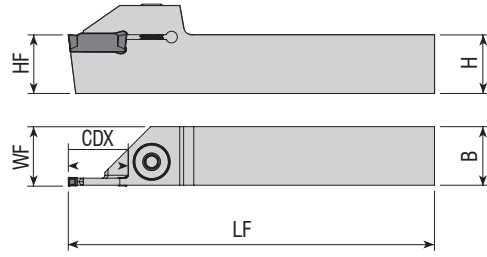

Takım Kodu Ordering Code Bestell-Bezeichnung	Stok Stock Lager		Takım Ölçüleri (mm) Dimension (mm) Abmessung (mm)				Kesici Uç Insert Wendeschneidplatte	Yedek Parçaları / Spare Parts / Ersatzteile							
	R	L	HF=H	B	LF	WF		CDX	Sıkma Vidası Screw Klemmschraube	Pul Stamp Ring	Anahtar Allen Key Innensechskantschlüssel				
ADKT-I-R/L-1212-2-T15	●	●	12	12	125	16.3	15	DGN - 2	AKV-02-M6x22	ABPL-01	AAL-03-3				
ADKT-I-R/L-1616-2-T15	●	●	16	16	100	16.3	15								
ADKT-I-R/L-2020-2-T15	●	●	20	20	125	20.3	15								
ADKT-I-R/L-2525-2-T15	●	●	25	25	150	25.3	15								
ADKT-I-R/L-3232-2-T15	●	●	32	32	170	32.3	15	DGN - 3	2004-M8x1x20	-	AAL-05-4				
ADKT-I-R/L-1212-3-T15	●	●	12	12	100	16.3	15								
ADKT-I-R/L-1616-3-T15	●	●	16	16	125	16.3	15								
ADKT-I-R/L-2020-3-T12	●	●	20	20	125	20.3	12								
ADKT-I-R/L-2020-3-T20	●	●	20	20	125	20.3	20								
ADKT-I-R/L-2525-3-T12	●	●	25	25	150	25.3	12								
ADKT-I-R/L-2525-3-T22	●	●	25	25	150	25.3	22								
ADKT-I-R/L-3232-3-T22	●	●	32	32	170	32.3	22								
ADKT-I-R/L-2020-4-T20	●	●	20	20	125	20.4	20								
ADKT-I-R/L-2525-4-T12	●	●	25	25	150	25.4	12								
ADKT-I-R/L-2525-4-T22	●	●	25	25	150	25.4	22								
ADKT-I-R/L-3232-4-T25	●	●	32	32	170	32.4	25								
ADKT-I-R/L-2020-5-T20	●	●	20	20	125	20.5	20	DGN / GRP - 5	AKV-02-M6x22	ABPL-01	AAL-03-3				
ADKT-I-R/L-2525-5-T12	●	●	25	25	150	25.5	12								
ADKT-I-R/L-2525-5-T25	●	●	25	25	150	25.5	25								
ADKT-IG-R/L-1616-3-T18	●	○	16	16	125	16.3	18	GRP - 3							
ADKT-IG-R/L-2020-3-T12	●	●	20	20	125	20.3	12								
ADKT-IG-R/L-2020-3-R20	●	●	20	20	125	20.3	20								
ADKT-IG-R/L-2525-3-T12	●	●	25	25	150	25.3	12								
ADKT-IG-R/L-2525-3-T22	●	●	25	25	150	25.3	22	GIM / GIP - 2				AKV-02-M6x22	ABPL-01	AAL-03-3	
ADKT-IGI-R/L-2020-2-T15	●	●	20	20	125	20.3	15								
ADKT-IGI-R/L-2525-2-T15	●	●	25	25	150	25.3	15								
ADKT-IGI-R/L-1616-3-T15	●	●	16	16	125	16.3	15								
ADKT-IGI-R/L-2020-3-T20	●	●	20	20	125	20.3	20								
ADKT-IGI-R/L-2525-3-T9	●	●	25	25	150	25.3	9								
ADKT-IGI-R/L-2525-3-T22	●	●	25	25	150	25.3	22								
ADKT-IGI-R/L-2525-4-T22	●	●	25	25	150	25.4	22								
ADKT-IGI-R/L-2525-5-T25	●	●	25	25	150	25.5	25								
new ADKT-IGI-R/L-2525-8-T25	●	○	25	25	150	25.8	25		GIM / GIP - 8	2505-M6x20	-				AAL-07-5
ADKT-IGI-R/L-2525-8-T30	●	○	25	25	150	25.8	30		GIM / GIP - 8	2004-M8x1x20	-				AAL-03-3
ADKT-IGTN-R/L-2525-5-T25	●	●	25	25	150	25.6	25		GTN - 5	2503-M4x19	-				AAL-05-4
new ADKT-IDC-R/L-1616-2-D35	○	●	16	16	140	16.2	35	DCE - 2	AKV-02-M6x22	ABPL-01	AAL-03-3				
new ADKT-IDC-R/L-2020-2-R23	●	○	20	20	125	20.2	23								
new ADKT-IDC-R/L-2525-2-R23	●	○	25	25	150	25.2	23	DCE - 3	2504-M5x18	-	AAL-05-4				
new ADKT-IDC-R/L-1616-3-D35	●	○	16	16	140	16.3	35								
ADKT-IDC-R/L-2525-3-T21	●	○	25	25	150	25.4	21	DCE - 3	2004-M8x1x20	-	AAL-05-4				

R: Sağ / Right / Rechts L: Sol / Left / Links

● Stokta / In Stock / Auf Lager ○ Stokta Yok / Non Stock Item / Kein Lagerartikel, Lieferzeit auf Anfrage  
ISCR Ucuna Uygundur. / Compatible with ISCR Insert. / Kompatibel mit ISCR Wendepplatten.

Sipariş Örneği/Ordering Example/Bestellbeispiel

1 ad./pcs./stück ADKT-I-R-1212-2-T15

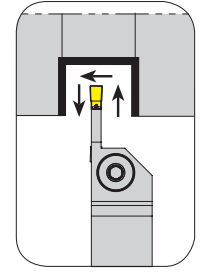
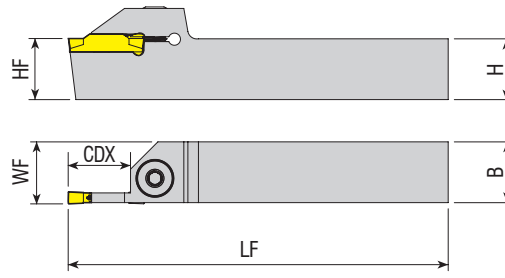

Takım Kodu Ordering Code Bestell-Bezeichnung	Stok Stock Lager		Takım Ölçüleri (mm) Dimension (mm) Abmessung (mm)					Kesici Uç Insert Wendeschneidplatte	Yedek Parçaları / Spare Parts / Ersatzteile						
	R	L	HF=H	B	LF	WF	CDX		Sıkma Vidası Screw Klemmschraube	Pul Stamp Ring	Anahtar Allen Key Innensechskantschlüssel				
ADKT-123-R/L-1212-1.5-R15	●	●	12	12	100	12.2	15	123 - 1.5	AKV-02-M6x22	ABPL-01	AAL-03-3				
ADKT-123-R/L-1616-1.5-R15	●	●	16	16	125	16.2	15								
<b>new</b> ADKT-123-R/L-2012-1.5-R15	○	●	20	12	125	12.5	15								
ADKT-123-R/L-1616-2-T15	●	○	16	16	125	16.2	15	123 - 2	AKV-02-M6x22	ABPL-01	AAL-03-3				
ADKT-123-R/L-2020-2-T8	●	●	20	20	125	20.2	8								
ADKT-123-R/L-2020-2-T15	●	●	20	20	125	20.2	15								
ADKT-123-R/L-2525-2-T8	●	●	25	25	150	25.2	8								
ADKT-123-R/L-2525-2-T15	●	●	25	25	150	25.2	15								
ADKT-123-R/L-3232-2-T15	●	●	32	32	170	32.2	15								
ADKT-123-R/L-1616-3-T10	●	●	16	16	125	16.3	10					123 - 3	2004-M8x1x20	-	AAL-05-4
ADKT-123-R/L-1616-3-T15	●	●	16	16	125	16.3	15								
ADKT-123-R/L-2020-3-T10	●	●	20	20	125	20.3	10								
ADKT-123-R/L-2020-3-T15	●	●	20	20	125	20.3	15								
ADKT-123-R/L-2020-3-T20	●	●	20	20	125	20.3	20								
ADKT-123-R/L-2525-3-T10	●	●	25	25	150	25.3	10								
ADKT-123-R/L-2525-3-T15	●	●	25	25	150	25.3	15								
ADKT-123-R/L-2525-3-T22	●	●	25	25	150	25.3	22								
ADKT-123-R/L-2020-4-T20	●	●	20	20	125	20.4	20	123 - 4	2004-M8x1x20	-	AAL-05-4				
ADKT-123-R/L-2525-4-T13	●	●	25	25	150	25.4	13								
ADKT-123-R/L-2525-4-T22	●	●	25	25	150	25.4	22								
ADKT-123-R/L-3232-4-T25	●	●	32	32	170	32.4	25								
ADKT-123-R/L-2020-5-T20	●	●	20	20	125	20.5	20	123 - 5	2004-M8x1x20	-	AAL-05-4				
ADKT-123-R/L-2525-5-T25	●	●	25	25	150	25.5	25								
ADKT-123-R/L-3232-6-T15	●	●	32	32	170	32.5	15	123 - 6	2004-M8x1x20	-	AAL-05-4				

R: Sağ / Right / Rechts L: Sol / Left / Links  
● Stokta / In Stock / Auf Lager ○ Stokta Yok / Non Stock Item / Kein Lagerartikel, Lieferzeit auf Anfrage  
SNDVK Ucuna Uygun. / Compatible with SNDVK Insert. / Kompatibel mit SNDVK Wendeplatten.

Sipariş Örneği/Ordering Example/Bestellbeispiel  
1 ad./pcs./stück ADKT-123-R-1212-1.5-R15

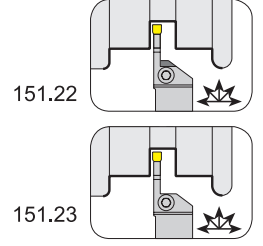
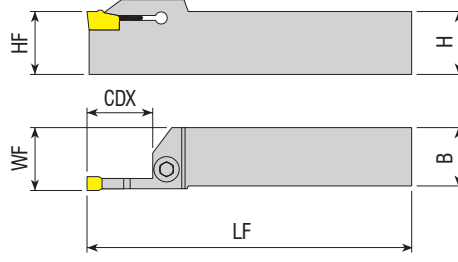

Takım Kodu Ordering Code Bestell-Bezeichnung	Stok Stock Lager		Takım Ölçüleri (mm) Dimension (mm) Abmessung (mm)				Kesici Uç Insert Wendeschneidplatte	Yedek Parçaları / Spare Parts / Ersatzteile			
	R	L	HF=H	B	LF	WF		CDX	Sıkma Vidası Screw Klemmschraube	Pul Stamp Ring	Anahtar Allen Key Innensechskantschlüssel
ADKT-151.22-R/L-1616-2-T15	●	●	16	16	125	16.3	15	151.2 - 2	AKV-02-M6x22	ABPL-01	AAL-03-3
ADKT-151.22-R/L-2020-2-T15	●	●	20	20	125	20.3	15				
ADKT-151.22-R/L-2525-2-T15	●	●	25	25	150	25.3	15	151.2 - 3	2004-M8x1x20	-	AAL-05-4
ADKT-151.22-R/L-1616-3-T15	●	●	16	16	125	16.4	15				
ADKT-151.22-R/L-2020-3-T20	●	●	20	20	125	20.4	20	151.2 - 4	2004-M8x1x20	-	AAL-05-4
ADKT-151.22-R/L-2525-3-T22	●	●	25	25	150	25.4	22				
ADKT-151.22-R/L-1616-4-T15	●	●	16	16	125	16.4	15	151.2 - 5	2004-M8x1x20	-	AAL-05-4
ADKT-151.22-R/L-2020-4-T20	●	●	20	20	125	20.4	20				
ADKT-151.22-R/L-2525-4-T22	●	●	25	25	150	25.4	22	151.2 - 5	2004-M8x1x20	-	AAL-05-4
ADKT-151.22-R/L-2020-5-T20	●	●	20	20	125	20.5	20				
ADKT-151.22-R/L-2525-5-T25	●	●	25	25	150	25.5	25	151.2 - 2	AKV-02-M6x22	ABPL-01	AAL-03-3
ADKT-151.23-R/L-1616-2-T15	●	●	16	16	125	16.3	15				
ADKT-151.23-R/L-2020-2-T15	●	●	20	20	125	20.3	15	151.2 - 2.5	AKV-02-M6x22	ABPL-01	AAL-03-3
ADKT-151.23-R/L-2525-2-T15	●	●	25	25	150	25.3	15				
ADKT-151.23-R/L-1616-2.5-T15	●	●	16	16	125	16.3	15	151.2 - 3	2004-M8x1x20	-	AAL-05-4
ADKT-151.23-R/L-2020-2.5-T15	●	●	20	20	125	20.3	15				
ADKT-151.23-R/L-2525-2.5-T15	●	●	25	25	150	25.3	15	151.2 - 4	2004-M8x1x20	-	AAL-05-4
ADKT-151.23-R/L-1212-3-T15	●	●	12	12	100	16.4	15				
ADKT-151.23-R/L-1616-3-T15	●	●	16	16	125	16.4	15	151.2 - 5	2004-M8x1x20	-	AAL-05-4
ADKT-151.23-R/L-2020-3-T20	●	●	20	20	125	20.4	20				
ADKT-151.23-R/L-2525-3-T20	●	●	25	25	150	25.4	20	151.2 - 5	2004-M8x1x20	-	AAL-05-4
ADKT-151.23-R/L-2525-3-T22	●	●	25	25	150	25.4	22				
ADKT-151.23-R/L-1616-4-T15	●	●	16	16	125	16.4	15	151.2 - 5	2004-M8x1x20	-	AAL-05-4
ADKT-151.23-R/L-2020-4-T20	●	●	20	20	125	20.4	20				
ADKT-151.23-R/L-2525-4-T22	●	●	25	25	150	25.4	22	151.2 - 5	2004-M8x1x20	-	AAL-05-4
ADKT-151.23-R/L-2020-5-T20	●	●	20	20	125	20.5	20				
ADKT-151.23-R/L-2525-5-T25	●	●	25	25	150	25.5	25				

R: Sağ / Right / Rechts L: Sol / Left / Links

● Stokta / In Stock / Auf Lager ○ Stokta Yok / Non Stock Item / Kein Lagerartikel, Lieferzeit auf Anfrage  
SNDVK Ucuna Uygunundur. / Compatible with SNDVK Insert. / Kompatibel mit SNDVK Wendeplatten.

Sipariş Örneği/Ordering Example/Bestellbeispiel  
1 ad./pcs./stück ADKT-151.22-R-1616-2-T15

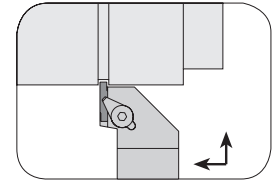
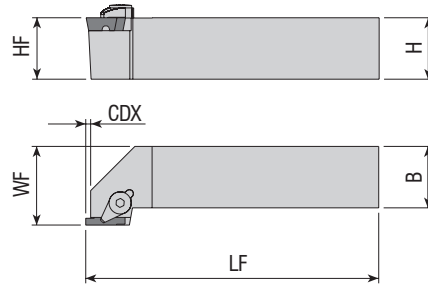

Takım Kodu Ordering Code Bestell-Bezeichnung	Stok Stock Lager		Takım Ölçüleri (mm) Dimension (mm) Abmessung (mm)					Kesici Uç Insert Wendeschneidplatte	Yedek Parçaları / Spare Parts / Ersatzteile				
	R	L	HF=H	B	LF	WF	CDX		Baskı Parçası Wedge Clamp Spannspratze	Sıkma Vidası Screw Klemmschraube	Pul Stamp Ring	Anahtar Allen Key Innensechskantschlüssel	
ADKT-154.91-R/L-2020-3-T4	●	●	20	20	125	25	4	154.91 - 3	ACK-03	AKV-07-M6x22	APM-06	AAL-03-3	
ADKT-154.91-R/L-2525-3-T4	●	●	25	25	150	30.5	4						
ADKT-154.91-R/L-2020-5-T5	●	●	20	20	125	25	5	154.91 - 5	ACK-03	AKV-07-M6x22	APM-06	AAL-03-3	
ADKT-154.91-R/L-2525-5-T5	●	●	25	25	150	30.5	5						

SNDVK Ucuna Uygunur. / Compatible with SNDVK Insert. / Kompatibel mit SNDVK Wendepplatten.

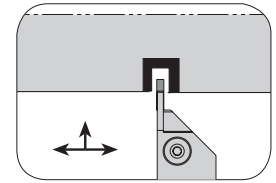
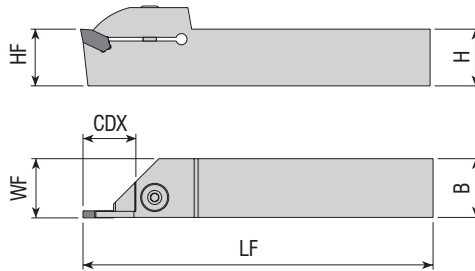

Takım Kodu Ordering Code Bestell-Bezeichnung	Stok Stock Lager		Takım Ölçüleri (mm) Dimension (mm) Abmessung (mm)					Kesici Uç Insert Wendeschneidplatte	Yedek Parçaları / Spare Parts / Ersatzteile			
	R	L	HF=H	B	LF	WF	CDX		Sıkma Vidası Screw Klemmschraube	Pul Stamp Ring	Anahtar Allen Key Innensechskantschlüssel	
ADKT-ARN-R/L-2020-2-T15	●	●	20	20	125	20.3	15	LOMR. - 2	AKV-02-M6x22	ABPL-01	AAL-03-3	
ADKT-ARN-R/L-2525-2-T15	●	●	25	25	150	25.3	15					
ADKT-ARN-R/L-2020-3-T20	●	●	20	20	125	20.4	20	LOMR. - 3	2004-M8x1x20	-	AAL-05-4	
ADKT-ARN-R/L-2525-3-T22	●	●	25	25	150	25.4	22					

R: Sağ / Right / Rechts L: Sol / Left / Links

● Stokta / In Stock / Auf Lager ○ Stokta Yok / Non Stock Item / Kein Lagerartikel, Lieferzeit auf Anfrage

ARN Ucuna Uygunur. / Compatible with ARN Insert. / Kompatibel mit ARN Wendepplatten.

Sipariş Örneği/Ordering Example/Bestellbeispiel

1 ad./pcs./stück ADKT-154.91-R-2020-3-T4

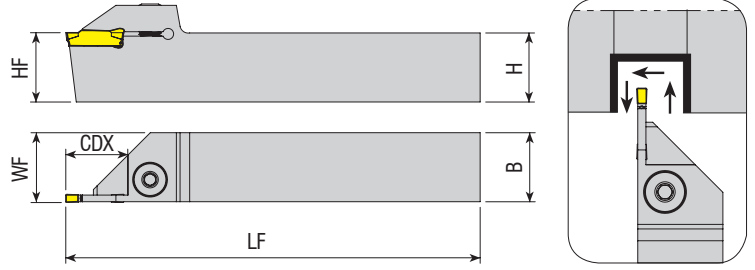

Takım Kodu Ordering Code Bestell-Bezeichnung	Stok Stock Lager		Takım Ölçüleri (mm) Dimension (mm) Abmessung (mm)				Kesici Uç Insert Wendeschneidplatte	Yedek Parçaları / Spare Parts / Ersatzteile			
	R	L	HF=H	B	LF	WF		CDX	Sıkma Vidası Screw Klemmschraube	Pul Stamp Ring	Anahtar Allen Key Innensechskantschlüssel
ADKT-TD-R/L-1212-2-T15	●	●	12	12	100	12.2	15	TD. - 2	AKV-02-M6x22	ABPL-01	AAL-03-3
ADKT-TD-R/L-1616-2-T8	●	●	16	16	125	16.2	8				
ADKT-TD-R/L-1616-2-T15	●	●	16	16	125	16.2	15				
ADKT-TD-R/L-2020-2-T9	●	○	20	20	125	20.2	9				
ADKT-TD-R/L-2020-2-T15	●	●	20	20	125	20.2	15				
ADKT-TD-R/L-2020-2-T17	●	○	20	20	125	20.2	17				
ADKT-TD-R/L-2020-2-T20	●	○	20	20	125	20.2	20				
ADKT-TD-R/L-2525-2-T8	●	●	25	25	150	25.2	8				
ADKT-TD-R/L-2525-2-T17	●	●	25	25	150	25.2	17				
ADKT-TD-R/L-1212-3-T15	●	●	12	12	100	12.4	15				
ADKT-TD-R/L-1616-3-T15	●	●	16	16	125	16.4	15				
ADKT-TD-R/L-2020-3-T12	●	●	20	20	125	20.4	12				
ADKT-TD-R/L-2020-3-T20	●	●	20	20	125	20.4	20				
ADKT-TD-R/L-2020-3-T25	●	○	20	20	125	20.4	25				
ADKT-TD-R/L-2020-3-T30	●	●	20	20	125	20.4	30				
ADKT-TD-R/L-2525-3-T9	●	●	25	25	150	25.4	9				
ADKT-TD-R/L-2525-3-T12	●	●	25	25	150	25.4	12				
ADKT-TD-R/L-2525-3-T22	●	●	25	25	150	25.4	22				
ADKT-TD-R/L-2525-3-T25	●	●	25	25	150	25.4	25				
ADKT-TD-R/L-2525-3-T30	●	●	25	25	150	25.4	30	TD. - 4			
ADKT-TD-R/L-3232-3-T25	●	○	32	32	170	32.4	25				
ADKT-TD-R/L-2525-4-T10	●	●	25	25	150	25.5	10				
ADKT-TD-R/L-2525-4-T15	●	●	25	25	150	25.5	15				
ADKT-TD-R/L-2525-4-T22	●	●	25	25	150	25.5	22				
ADKT-TD-R/L-2525-4-T25	●	○	25	25	150	25.4	25	TD. - 5			
ADKT-TD-R/L-2525-4-T30	●	○	25	25	150	25.5	30				
ADKT-TD-R/L-2525-5-T25	●	●	25	25	150	25.5	25				

TGTC Ucuna Uygun. / Compatible with TGTC Insert. / Kompatibel mit TGTC Wendepfatten.

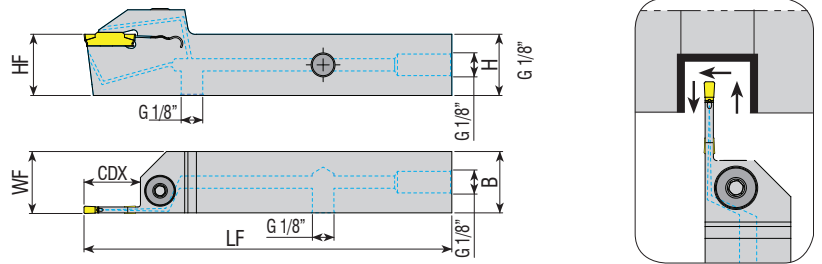

Takım Kodu Ordering Code Bestell-Bezeichnung	Stok Stock Lager		Takım Ölçüleri (mm) Dimension (mm) Abmessung (mm)				Kesici Uç Insert Wendeschneidplatte	Yedek Parçaları / Spare Parts / Ersatzteile			
	R	L	HF=H	B	LF	WF		CDX	Sıkma Vidası Screw Klemmschraube	Pul Stamp Ring	Anahtar Allen Key Innensechskantschlüssel
ADKT-TD-R/L-2020-3-T30-H	●	●	20	20	125	20.5	30	TD. - 3	2004-M8x1x20	-	AAL-05-4

R: Sağ / Right / Rechts L: Sol / Left / Links  
● Stokta / In Stock / Auf Lager ○ Stokta Yok / Non Stock Item / Kein Lagerartikel, Lieferzeit auf Anfrage  
TGTC Ucuna Uygun. / Compatible with TGTC Insert. / Kompatibel mit TGTC Wendepfatten.

Sipariş Örneği/Ordering Example/Bestellbeispiel  
1 ad./pcs./stück ADKT-TD-R-1212-2-T15



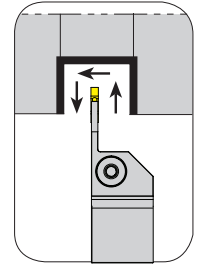
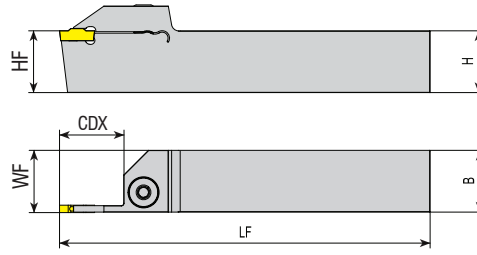

**Takım Kodu**  
**Ordering Code**  
**Bestell-Bezeichnung**

Takım Kodu Ordering Code Bestell-Bezeichnung	Stok Stock Lager		Takım Ölçüleri (mm) Dimension (mm) Abmessung (mm)				Kesici Uç Insert Wendeschneidplatte	Yedek Parçaları / Spare Parts / Ersatzteile				
	R	L	HF=H	B	LF	WF		CDX	Sıkma Vidası Screw Klemmschraube	Pul Stamp Ring	Anahtar Allen Key Innensechskantschlüssel	Tork Anahtar Torx Key Torx Innensechskantschlüssel
ADKT-RD-R/L-1616-2-T17	●	○	16	16	125	16.2	17	RD. - 2	AKV-02-M6x22	ABPL-01	AAL-03-3	
ADKT-RD-R/L-2020-2-T17	●	○	20	20	125	20.2	17					
ADKT-RD-R/L-2525-2-T17	●	○	25	25	150	25.2	17					
ADKT-RD-R/L-1616-3-T20	●	●	16	16	125	16.3	20	RD. - 3	2004-M8x1x20	-	AAL-05-4	-
ADKT-RD-R/L-2020-3-T25	●	○	20	20	125	20.3	25					
ADKT-RD-R/L-2525-3-T25	●	○	25	25	150	25.3	25					
ADKT-RD-R/L-2020-4-T30	●	●	20	20	125	20.4	30	RD. - 4	2004-M8x1x20	-	AAL-05-4	-
ADKT-RD-R/L-2525-4-T30	●	○	25	25	150	25.5	30					

TGTC Ucuna Uygun. / Compatible with TGTC Insert. / Kompatibel mit TGTC Wendepatten.

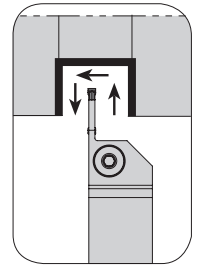
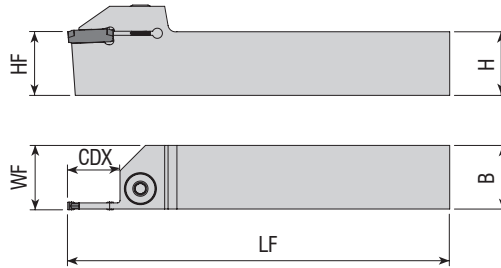

**Takım Kodu**  
**Ordering Code**  
**Bestell-Bezeichnung**

Takım Kodu Ordering Code Bestell-Bezeichnung	Stok Stock Lager		Takım Ölçüleri (mm) Dimension (mm) Abmessung (mm)				Kesici Uç Insert Wendeschneidplatte	Yedek Parçaları / Spare Parts / Ersatzteile			
	R	L	HF=H	B	LF	WF		CDX	Sıkma Vidası Screw Klemmschraube	Pul Stamp Ring	Anahtar Allen Key Innensechskantschlüssel
ADKT-LGC-R/L-1616-2-D40	●	●	16	16	125	16.2	20	GCTX - 2	AKV-02-M6x22	ABPL-01	AAL-03-3
ADKT-LGC-R/L-2020-2-D40	●	●	20	20	125	20.2	20				
ADKT-LGC-R/L-2525-2-D40	●	●	25	25	150	25.2	20				
ADKT-LGC-R/L-1616-3-T20	●	●	16	16	125	16.3	20	GCTX - 3	2004-M8x1x20	-	AAL-05-4
ADKT-LGC-R/L-2020-3-T20	●	●	20	20	125	20.3	20				
ADKT-LGC-R/L-2525-3-T20	●	●	25	25	150	25.3	20				

R: Sağ / Right / Rechts L: Sol / Left / Links

● Stokta / In Stock / Auf Lager ○ Stokta Yok / Non Stock Item / Kein Lagerartikel, Lieferzeit auf Anfrage

LMN Ucuna Uygun. / Compatible with LMN Insert. / Kompatibel mit LMN Wendepatten.

Sipariş Örneği/Ordering Example/Bestellbeispiel  
1 ad./pcs./stück ADKT-RD-R-1616-2-T17

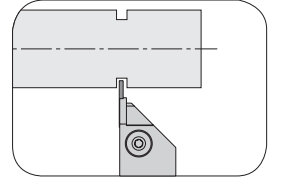
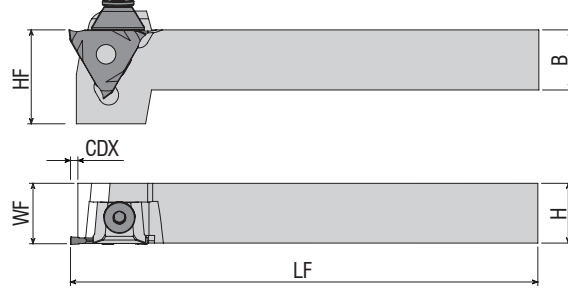

Takım Kodu Ordering Code Bestell-Bezeichnung	Stok Stock Lager		Takım Ölçüleri (mm) Dimension (mm) Abmessung (mm)				Kesici Uç Insert Wendeschneidplatte	Yedek Parçaları / Spare Parts / Ersatzteile				
	R	L	HF=H	B	LF	WF		CDX	Sıkma Vidası Screw Klemmschraube	Baskı Pabucu Wedge Clamp Spannpratze	Segman Ring Feder	Anahtar Allen Key Innensechskantschlüssel
ADKT-H22-R/L-1616-(0.5-2)-T4	●	●	16	16	125	16.35	4	S312 - (0.5-2)	AKV-29-M6x29	AKK-04	AS-01	AAL-03-3
ADKT-H22-R/L-2020-(0.5-2)-T4	●	●	20	20	125	20.35	4					
<b>new</b> ADKT-H22-R/L-2020-(0.5-2)-T6x20	●	○	20	20	125	20.2	20					
ADKT-H22-R/L-2525-(0.5-2)-T4	●	●	25	25	150	25.35	4					
<b>new</b> ADKT-H22-R/L-2525-(0.5-2)-T6x20	●	○	25	25	150	20.2	2					

HRN Ucuna Uygun. / Compatible with HRN Insert. / Kompatibel mit HRN Wendepfatten.

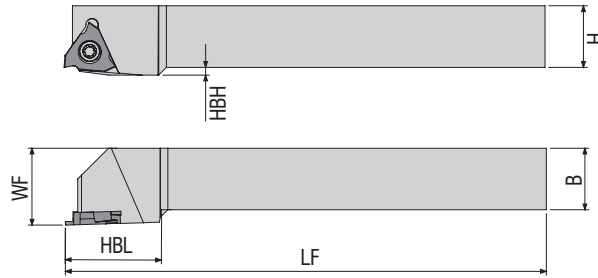
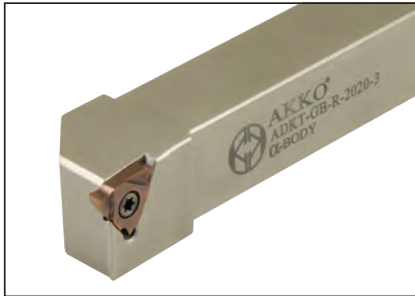

Takım Kodu Ordering Code Bestell-Bezeichnung	Stok Stock Lager		Takım Ölçüleri (mm) Dimension (mm) Abmessung (mm)			Kesici Uç Insert Wendeschneidplatte	Yedek Parçaları / Spare Parts / Ersatzteile			
	R	L	HF=H	B	LF		WF	Sıkma Vidası Screw Klemmschraube	Pul Stamp Ring	Tork Anahtar Torx Key Torx Innensechskantschlüssel
ADKT-GB-R/L-1212-3	●	○	12	12	100	16	GB3100	4015-M3.5x10	-	80-T15
ADKT-GB-R/L-1616-3	●	○	16	16	125	20				
ADKT-GB-R/L-2020-3	●	○	20	20	125	25				

R: Sağ / Right / Rechts L: Sol / Left / Links

● Stokta / In Stock / Auf Lager ○ Stokta Yok / Non Stock Item / Kein Lagerartikel, Lieferzeit auf Anfrage

XTC-GSC Ucuna Uygun. / Compatible with XTC-GSC Insert. / Kompatibel mit XTC-GSC Wendepfatten.

Sipariş Örneği/Ordering Example/Bestellbeispiel

1 ad./pcs./stück ADKT-H22-R-1616-(0.5-2)-T4

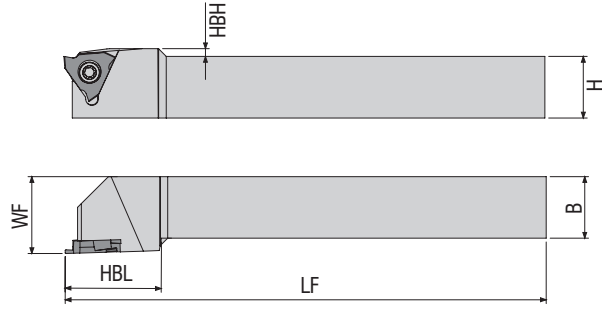
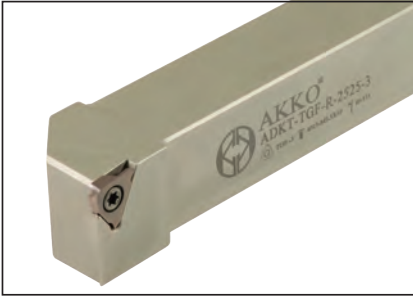

Takım Kodu Ordering Code Bestell-Bezeichnung	Stok Stock Lager		Takım Ölçüleri (mm) Dimension (mm) Abmessung (mm)				Kesici Uç Insert Wendeschneidplatte	Yedek Parçaları / Spare Parts / Ersatzteile		
	R	L	HF=H	B	LF	WF		Sıkma Vidası Screw Klemmschraube	Pul Stamp Ring	Tork Anahtar Torx Key Torx Innensechskantschlüssel
ADKT-TGF-R/L-1616-3	●	○	16	16	125	20				
ADKT-TGF-R/L-2020-3	●	○	20	20	125	25	QC16L150	4015-M3.5X10	-	80-T15
ADKT-TGF-R/L-2525-3	●	○	25	25	150	32				

NTK Ucuna Uygun. / Compatible with NTK Insert. / Kompatibel mit NTK Wendeplatten.

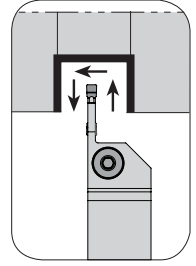
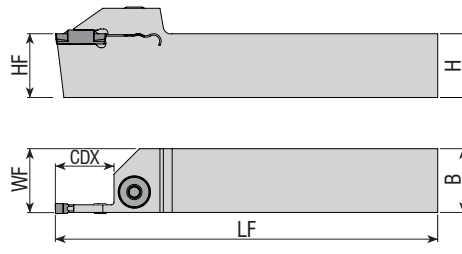

Takım Kodu Ordering Code Bestell-Bezeichnung	Stok Stock Lager		Takım Ölçüleri (mm) Dimension (mm) Abmessung (mm)					Kesici Uç Insert Wendeschneidplatte	Yedek Parçaları / Spare Parts / Ersatzteile		
	R	L	HF=H	B	LF	WF	CDX		Sıkma Vidası Screw Klemmschraube	Pul Stamp Ring	Anahtar Allen Key Innensechskantschlüssel
ADKT-TG-R/L-1616-2-R17	●	○	16	16	125	16.2	17				
ADKT-TG-R/L-2020-2-R8	●	○	20	20	125	20.2	8				
ADKT-TG-R/L-2020-2-T8	●	○	20	20	125	20.2	8				
ADKT-TG-R/L-2020-2-R12	●	○	20	20	125	20.2	12				
ADKT-TG-R/L-2020-2-R17	●	○	20	20	125	20.2	17				
ADKT-TG-R/L-2525-2-R12	●	○	25	25	150	25.2	12				
ADKT-TG-R/L-2525-2-R17	●	○	25	25	150	25.2	17				
ADKT-TG-R/L-1616-3-T20	●	○	16	16	125	16.3	20				
ADKT-TG-R/L-2020-3-T12	●	○	20	20	125	20.3	12				
ADKT-TG-R/L-2020-3-T20	●	○	20	20	125	20.3	20				
ADKT-TG-R/L-2525-3-T9	●	○	25	25	150	25.3	9				
ADKT-TG-R/L-2525-3-T20	●	○	25	25	150	25.3	20				
ADKT-TG-R/L-2525-3-R25	●	○	25	25	150	25.3	25				
ADKT-TG-R/L-2525-4-T15	●	○	25	25	150	25.5	15				
ADKT-TG-R/L-2525-4-T20	●	○	25	25	150	25.5	20				
ADKT-TG-R/L-2525-4-T25	●	○	25	25	150	25.5	25				
ADKT-TG-R/L-2525-5-T12	●	○	25	25	150	25.5	12				
ADKT-TG-R/L-2525-5-T25	●	○	25	25	150	25.5	25				
ADKT-TG-R/L-2525-5-T32	●	○	25	25	150	25.5	32				

R: Sağ / Right / Rechts L: Sol / Left / Links

● Stokta / In Stock / Auf Lager ○ Stokta Yok / Non Stock Item / Kein Lagerartikel, Lieferzeit auf Anfrage  
TNGLY Ucuna Uygun. / Compatible with TNGLY Insert. / Kompatibel mit TNGLY Wendeplatten.

Sipariş Örneği/Ordering Example/Bestellbeispiel  
1 ad./pcs./stück ADKT-TGF-R-1616-3

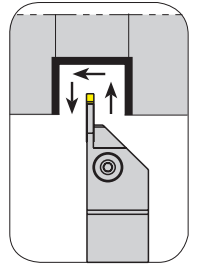
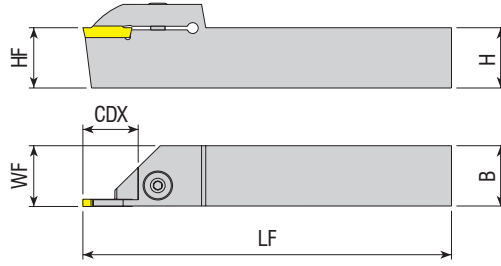

Takım Kodu Ordering Code Bestell-Bezeichnung	Stok Stock Lager		Takım Ölçüleri (mm) Dimension (mm) Abmessung (mm)					Kesici Uç Insert Wendeschneidplatte	Yedek Parçaları / Spare Parts / Ersatzteile			
	R	L	HF=H	B	LF	WF	CDX		Sıkma Vidası Screw Klemmschraube	Pul Stamp Ring	Anahtar Allen Key Innensechskantschlüssel	
ADKT-WGX16-R/L-2020-2-R16	●	○	20	20	125	20.2	16	GX16. - 2	AKV-02-M6x22	ABPL-01	AAL-03-3	
ADKT-WGX16-R/L-2525-2-R16	●	○	25	25	150	25.2	16					
ADKT-WGX24-R/L-2020-3-T20	●	●	20	20	125	20.4	20	GX24. - 3	2004-M8x1x20	-	AAL-05-4	
ADKT-WGX24-R/L-2525-3-T12	●	●	25	25	150	25.4	12					
ADKT-WGX24-R/L-2525-3-T22	●	●	25	25	150	25.4	22	GX24. - 4	-	-	-	
ADKT-WGX24-R/L-3232-3-T22	●	○	32	32	170	32.4	22					
ADKT-WGX24-R/L-2525-4-T22	●	●	25	25	150	25.5	22	GX24. - 5	-	-	-	
ADKT-WGX24-R/L-2525-5-T25	●	●	25	25	150	25.5	25					
ADKT-WGX24-R/L-3232-5-T25	●	●	32	32	170	32.5	25					

WLTR Ucuna Uygun. / Compatible with WLTR Insert. / Kompatibel mit WLTR Wendepfatten.

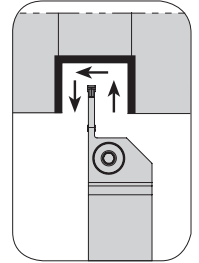
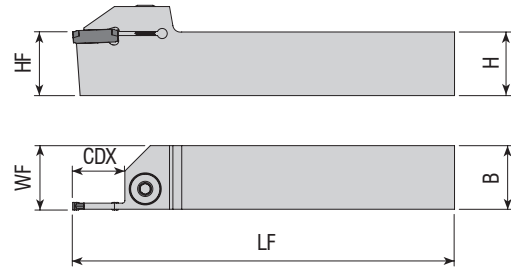

Takım Kodu Ordering Code Bestell-Bezeichnung	Stok Stock Lager		Takım Ölçüleri (mm) Dimension (mm) Abmessung (mm)					Kesici Uç Insert Wendeschneidplatte	Yedek Parçaları / Spare Parts / Ersatzteile			
	R	L	HF=H	B	LF	WF	CDX		Sıkma Vidası Screw Klemmschraube	Pul Stamp Ring	Anahtar Allen Key Innensechskantschlüssel	
ADKT-GP-R/L-2020-2-T15	●	●	20	20	125	20.2	15	GP - 2	AKV-02-M6x22	ABPL-01	AAL-03-3	
ADKT-GP-R/L-2525-2-T15	●	●	25	25	150	25.2	15					
ADKT-GP-R/L-2020-3-T20	●	●	20	20	125	20.3	20	GP - 3	2004-M8x1x20	-	AAL-05-4	
ADKT-GP-R/L-2525-3-T22	●	●	25	25	150	25.3	22					
ADKT-GP-R/L-2525-4-T22	●	●	25	25	150	25.4	22	GP - 4	-	-	-	
ADKT-GP-R/L-2525-5-T25	●	●	25	25	150	25.5	25					
ADKT-GP-R/L-2525-5-T25	●	●	25	25	150	25.5	25	GP - 5				

R: Sağ / Right / Rechts L: Sol / Left / Links

● Stokta / In Stock / Auf Lager ○ Stokta Yok / Non Stock Item / Kein Lagerartikel, Lieferzeit auf Anfrage  
PLBT Ucuna Uygun. / Compatible with PLBT Insert. / Kompatibel mit PLBT Wendepfatten.

Sipariş Örneği/Ordering Example/Bestellbeispiel  
1 ad./pcs./stück ADKT-WGX16-R-2020-2-R16

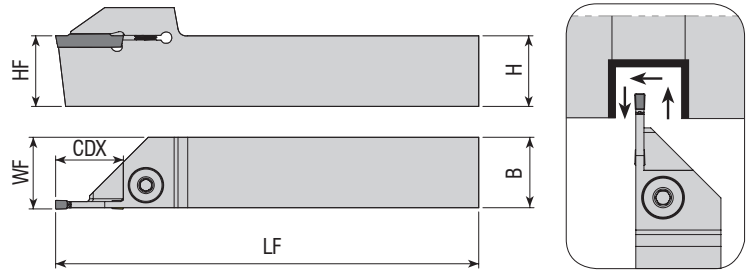

**Takım Kodu**  
**Ordering Code**  
**Bestell-Bezeichnung**

Stok Stock Lager	Takım Ölçüleri (mm) Dimension (mm) Abmessung (mm)						Kesici Uç Insert Wendeschneidplatte	Yedek Parçaları / Spare Parts / Ersatzteile			
	R	L	HF=H	B	LF	WF		CDX	Sıkma Vidası Screw Klemmschraube	Pul Stamp Ring	Anahtar Allen Key Innensechskantschlüssel
ADKT-CD-R/L-2020-3-R20	●	○	20	20	125	20.3	20				
ADKT-CD-R/L-2525-3-R23	●	○	25	25	150	25.3	23	<b>GX24 0300</b>	2004-M8x1x20	-	AAL-05-4

CRTZT Ucuna Uygundur. / Compatible with CRTZT Insert. / Kompatibel mit CRTZT Wendeplatten.

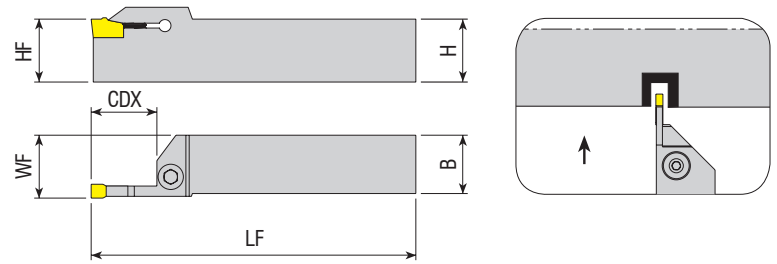

**Takım Kodu**  
**Ordering Code**  
**Bestell-Bezeichnung**

Stok Stock Lager	Takım Ölçüleri (mm) Dimension (mm) Abmessung (mm)						Kesici Uç Insert Wendeschneidplatte	Yedek Parçaları / Spare Parts / Ersatzteile			
	R	L	HF=H	B	LF	WF		CDX	Sıkma Vidası Screw Klemmschraube	Pul Stamp Ring	Anahtar Allen Key Innensechskantschlüssel
ADKT-SWC-R/L-2020-2-T25	●	○	20	20	125	20.3	25				
ADKT-SWC-R/L-2020-3-T25	●	○	20	20	125	20.4	25	<b>WCF-3</b>	2004-M8x1x20	-	AAL-05-4

SMTM Ucuna Uygundur. / Compatible with SMTM Insert. / Kompatibel mit SMTM Wendeplatten.

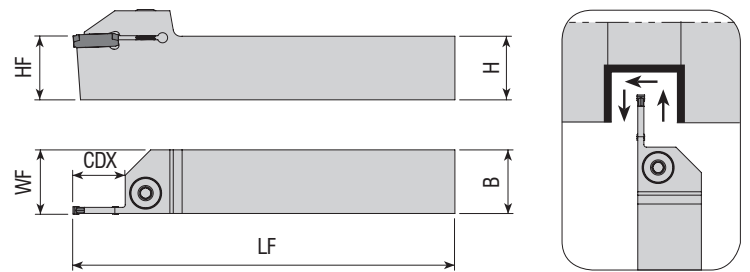

**Takım Kodu**  
**Ordering Code**  
**Bestell-Bezeichnung**

Stok Stock Lager	Takım Ölçüleri (mm) Dimension (mm) Abmessung (mm)						Kesici Uç Insert Wendeschneidplatte	Yedek Parçaları / Spare Parts / Ersatzteile			
	R	L	HF=H	B	LF	WF		CDX	Sıkma Vidası Screw Klemmschraube	Pul Stamp Ring	Anahtar Allen Key Innensechskantschlüssel
ADKT-GY2-R/L-2525-2-R20	●	○	25	25	150	25.2	20				
ADKT-GY2-R/L-2525-3-R20	●	○	25	25	150	25.3	20	<b>GY2M-0300</b>	2004-M8x1x20	-	AAL-05-4
ADKT-GY2-R/L-2525-4-T25	●	○	25	25	150	25.4	25	<b>GY2M-0400</b>	2004-M8x1x20	-	AAL-05-4
ADKT-GY2-R/L-2525-5-T25	●	○	25	25	150	25.5	25	<b>GY2M-0500</b>	2004-M8x1x20	-	AAL-05-4

R: Sağ / Right / Rechts L: Sol / Left / Links

● Stokta / In Stock / Auf Lager ○ Stokta Yok / Non Stock Item / Kein Lagerartikel, Lieferzeit auf Anfrage

MTSBH Ucuna Uygundur. / Compatible with MTSBH Insert. / Kompatibel mit MTSBH Wendeplatten.

Sipariş Örneği/Ordering Example/Bestellbeispiel

1 ad./pcs./stück ADKT-CD-R-2020-3-R20

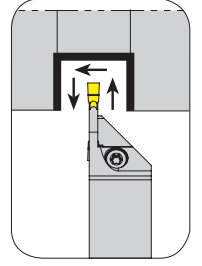
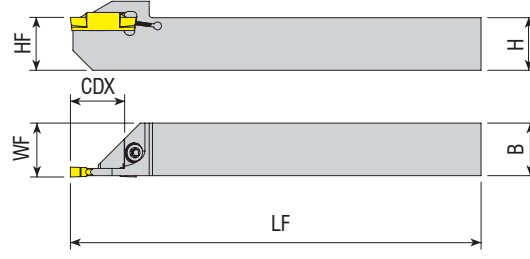

Takım Kodu Ordering Code Bestell-Bezeichnung	Stok Stock Lager		Takım Ölçüleri (mm) Dimension (mm) Abmessung (mm)					Kesici Uç Insert Wendeschneidplatte	Yedek Parçaları / Spare Parts / Ersatzteile			
	R	L	HF=H	B	LF	WF	CDX		Sıkma Vidası Screw Klemmschraube	Pul Stamp Ring	Tork Anahtar Torx Key Torx Innensechskantschlüssel	
<b>new</b> ADKT-TD-R/L-1010-2-R10-K-S	●	●	10	10	125	10.2	10	TD. - 2	4015-M4x11	-	80-T15	
ADKT-TD-R/L-1212-2-T12-K-S	●	●	12	12	125	12.2	12					
ADKT-TD-R/L-1616-2-T16-K-S	●	●	16	16	125	16.2	16	TD. - 3	4015-M4x11	-	80-T15	
ADKT-TD-R/L-1212-3-T12-K-S	●	●	12	12	125	12.3	12					
ADKT-TD-R/L-1616-3-T16-K-S	●	●	16	16	125	16.3	16					

TGTC Ucuna Uygun. / Compatible with TGTC Insert. / Kompatibel mit TGTC Wendeplatten.

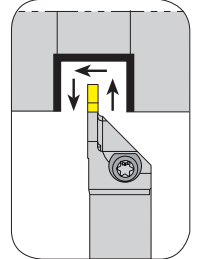
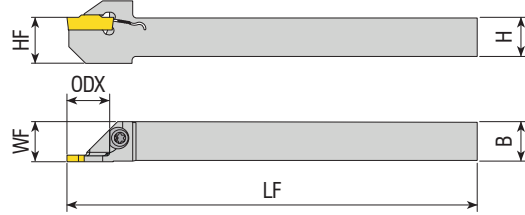

Takım Kodu Ordering Code Bestell-Bezeichnung	Stok Stock Lager		Takım Ölçüleri (mm) Dimension (mm) Abmessung (mm)					Kesici Uç Insert Wendeschneidplatte	Yedek Parçaları / Spare Parts / Ersatzteile			
	R	L	HF=H	B	LF	WF	CDX		Sıkma Vidası Screw Klemmschraube	Pul Stamp Ring	Tork Anahtar Torx Key Torx Innensechskantschlüssel	
ADKT-RD-R/L-1212-2-T12-K-S	●	●	12	12	125	12.2	12	RD. - 2	4015-M4x11	-	80-T15	
ADKT-RD-R/L-1616-2-T17-K-S	●	●	16	16	125	16.2	17					
ADKT-RD-R/L-1212-3-T12-K-S	●	●	12	12	125	12.2	12	RD. - 3	4015-M4x11	-	80-T15	

R: Sağ / Right / Rechts L: Sol / Left / Links

● Stokta / In Stock / Auf Lager ○ Stokta Yok / Non Stock Item / Kein Lagerartikel, Lieferzeit auf Anfrage

TGTC Ucuna Uygun. / Compatible with TGTC Insert. / Kompatibel mit TGTC Wendeplatten.

Sipariş Örneği/Ordering Example/Bestellbeispiel

1 ad./pcs./stück ADKT-TD-R-1010-2-R10-K-S

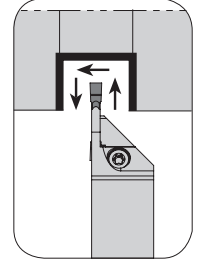
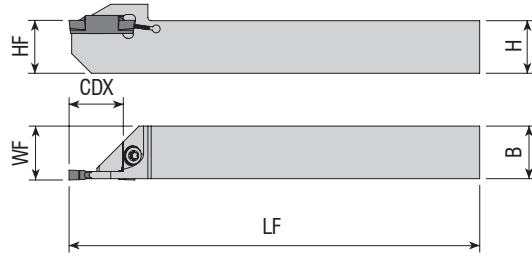

Takım Kodu Ordering Code Bestell-Bezeichnung	Stok Stock Lager		Takım Ölçüleri (mm) Dimension (mm) Abmessung (mm)					Kesici Uç Insert Wendeschneidplatte	Yedek Parçaları / Spare Parts / Ersatzteile			
	R	L	HF=H	B	LF	WF	CDX		Sıkma Vidası Screw Klemmschraube	Pul Stamp Ring	Tork Anahtar Torx Key Torx Innensechskantschlüssel	
ADKT-ZCC2-R/L-1010-2-T12-K-S	●	●	10	10	125	10.2	12	Z.BD - 2	4015-M4x11	-	80-T15	
ADKT-ZCC2-R/L-1212-2-T12-K-S	●	●	12	12	125	12.2	12					
ADKT-ZCC2-R/L-1616-2-R16-K-S	●	●	16	16	125	16.2	16	Z.FD - 3	4015-M4x11	-	80-T15	
ADKT-ZCC2-R/L-1212-3-T12-K-S	●	●	12	12	125	12.3	12					

ZCC Ucuna Uygundur. / Compatible with ZCC Insert. / Kompatibel mit ZCC Wendeplatten.

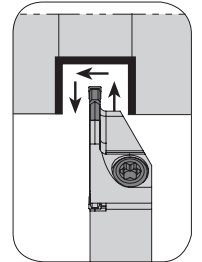
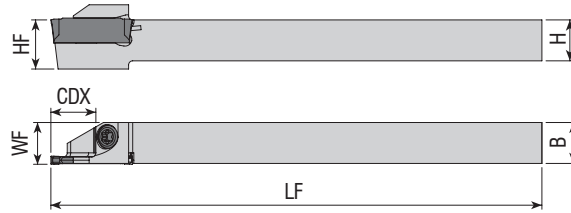

Takım Kodu Ordering Code Bestell-Bezeichnung	Stok Stock Lager		Takım Ölçüleri (mm) Dimension (mm) Abmessung (mm)					Kesici Uç Insert Wendeschneidplatte	Yedek Parçaları / Spare Parts / Ersatzteile			
	R	L	HF=H	B	LF	WF	CDX		Sıkma Vidası Screw Klemmschraube	Pul Stamp Ring	Tork Anahtar Torx Key Torx Innensechskantschlüssel	
ADKT-I-R/L-0808-2-R10-S	●	●	08	08	100	8.2	10	DGN - 2	4015-M4x11	-	80-T15	
ADKT-I-R/L-1010-2-R10-K-S	●	●	10	10	125	10.2	10					
ADKT-I-R/L-1212-2-R12-K-S	●	●	12	12	125	12.2	12	DGN - 3	4015-M4x11	-	80-T15	
ADKT-I-R/L-1616-2-R16-K-S	●	○	16	16	125	16.2	16					
ADKT-I-R/L-1616-3-R16-K-S	●	●	16	16	125	16.3	16					

R: Sağ / Right / Rechts L: Sol / Left / Links  
● Stokta / In Stock / Auf Lager ○ Stokta Yok / Non Stock Item / Kein Lagerartikel, Lieferzeit auf Anfrage  
ISCR Ucuna Uygundur. / Compatible with ISCR Insert. / Kompatibel mit ISCR Wendeplatten.

Sipariş Örneği/Ordering Example/Bestellbeispiel  
1 ad./pcs./stück ADKT-ZCC2-R-1010-2-T12-K-S

DIŞ ÇAP KANAL AÇMA İSVİÇRE TİPİ KAYAR OTOMAT MAKİNA TAKIMLARI  
EXTERNAL GROOVING TOOLHOLDERS FOR SWISS TYPE SLIDING AUTOMATIC LATHES  
WERKZEUGE ZUR STECHBEARBEITUNG AUF LANGDREHAUTOMATEN

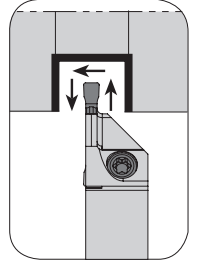
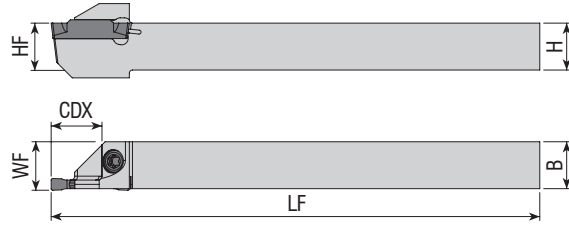

Takım Kodu Ordering Code Bestell-Bezeichnung	Stok Stock Lager		Takım Ölçüleri (mm) Dimension (mm) Abmessung (mm)				Kesici Uç Insert Wendeschneidplatte	Yedek Parçaları / Spare Parts / Ersatzteile			
	R	L	HF=H	B	LF	WF		CDX	Sıkma Vidası Screw Klemmschraube	Pul Stamp Ring	Tork Anahtar Torx Key Torx Innensechskantschlüssel
ADKT-KG-R/L-1212-2-R12-K-S	●	●	12	12	125	12.2	12	KG. - 2	4015-M4x11	-	80-T15
ADKT-KG-R/L-1616-2-R16-K-S	●	●	16	16	125	16.2	16				
ADKT-KG-R/L-1212-3-R12-K-S	●	●	12	12	125	12.3	12	KG. - 3	4015-M4x11	-	80-T15
ADKT-KG-R/L-1616-3-R16-K-S	●	●	16	16	125	16.3	16				

KRLY Ucuna Uygunudur. / Compatible with KRLY Insert. / Kompatibel mit KRLY Wendepplatten.

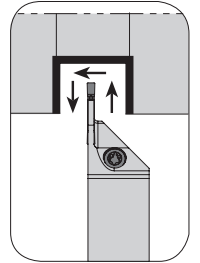
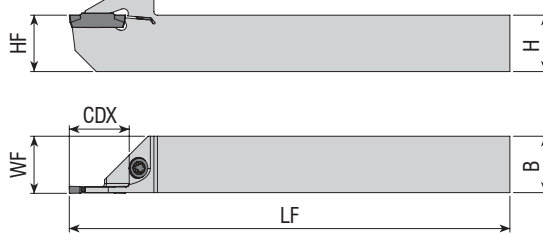

Takım Kodu Ordering Code Bestell-Bezeichnung	Stok Stock Lager		Takım Ölçüleri (mm) Dimension (mm) Abmessung (mm)				Kesici Uç Insert Wendeschneidplatte	Yedek Parçaları / Spare Parts / Ersatzteile			
	R	L	HF=H	B	LF	WF		CDX	Sıkma Vidası Screw Klemmschraube	Pul Stamp Ring	Tork Anahtar Torx Key Torx Innensechskantschlüssel
ADKT-K-R/L-1212-2-R12-K-S	●	●	12	12	125	12.20	12	MGM. - 2	4015-M4x11	-	80-T15
ADKT-K-R/L-1616-2-R16-K-S	●	●	16	16	125	16.20	16				
ADKT-K-R/L-1212-3-R12-K-S	●	●	12	12	125	12.30	12	MGM. - 3	4015-M4x11	-	80-T15
ADKT-K-R/L-1616-3-R16-K-S	●	●	16	16	125	16.30	16				

R: Sağ / Right / Rechts L: Sol / Left / Links

● Stokta / In Stock / Auf Lager ○ Stokta Yok / Non Stock Item / Kein Lagerartikel, Lieferzeit auf Anfrage

KRLY Ucuna Uygunudur. / Compatible with KRLY Insert. / Kompatibel mit KRLY Wendepplatten.

Sipariş Örneği/Ordering Example/Bestellbeispiel

1 ad./pcs./stück ADKT-KG-R-1212-2-R12-K-S



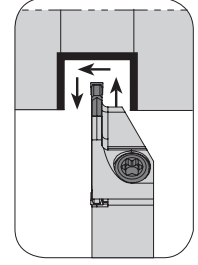
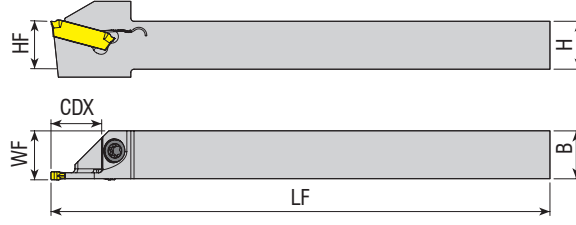

Takım Kodu Ordering Code Bestell-Bezeichnung	Stok Stock Lager		Takım Ölçüleri (mm) Dimension (mm) Abmessung (mm)					Kesici Uç Insert Wendeschneidplatte	Yedek Parçaları / Spare Parts / Ersatzteile			
	R	L	HF=H	B	LF	WF	CDX		Sıkma Vidası Screw Klemmschraube	Pul Stamp Ring	Tork Anahtar Torx Key Torx Innensechskantschlüssel	
ADKT-WGX16-R/L-1212-2-R12-K-S	●	●	12	12	125	12.2	12	GX16. - 2	4015-M4x11	-	80-T15	
ADKT-WGX16-R/L-1616-2-R16-K-S	●	○	16	16	125	16.2	16					
ADKT-WGX24-R/L-1616-3-R16-K-S	●	○	16	16	125	16.3	16					GX24. - 3

WLTR Ucuna Uygun. / Compatible with WLTR Insert. / Kompatibel mit WLTR Wendeplatten.

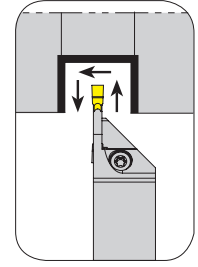
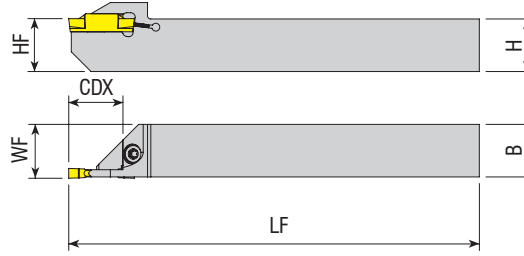

Takım Kodu Ordering Code Bestell-Bezeichnung	Stok Stock Lager		Takım Ölçüleri (mm) Dimension (mm) Abmessung (mm)					Kesici Uç Insert Wendeschneidplatte	Yedek Parçaları / Spare Parts / Ersatzteile			
	R	L	HF=H	B	LF	WF	CDX		Sıkma Vidası Screw Klemmschraube	Pul Stamp Ring	Tork Anahtar Torx Key Torx Innensechskantschlüssel	
ADKT-TG-R/L-1212-2-R12-K-S	●	○	12	12	125	12.2	12	DGM2-020	4015-M4x11	-	80-T15	
ADKT-TG-R/L-1212-3-R12-K-S	●	○	12	12	125	12.3	12	DGM3-020				

TNGLY Ucuna Uygun. / Compatible with TNGLY Insert. / Kompatibel mit TNGLY Wendeplatten.

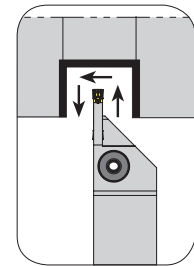
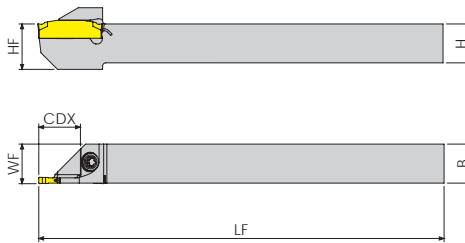

Takım Kodu Ordering Code Bestell-Bezeichnung	Stok Stock Lager		Takım Ölçüleri (mm) Dimension (mm) Abmessung (mm)					Kesici Uç Insert Wendeschneidplatte	Yedek Parçaları / Spare Parts / Ersatzteile			
	R	L	HF=H	B	LF	WF	CDX		Sıkma Vidası Screw Klemmschraube	Pul Stamp Ring	Tork Anahtar Torx Key Torx Innensechskantschlüssel	
ADKT-123-R/L-1212-2-T12-K-S	●	○	12	12	125	12.2	12	123 - 2	4015-M4x11	-	80-T15	
ADKT-123-R/L-1212-3-T12-K-S	○	○	12	12	125	12.3	12	123 - 3				

R: Sağ / Right / Rechts L: Sol / Left / Links  
● Stokta / In Stock / Auf Lager ○ Stokta Yok / Non Stock Item / Kein Lagerartikel, Lieferzeit auf Anfrage  
SNDVK Ucuna Uygun. / Compatible with SNDVK Insert. / Kompatibel mit SNDVK Wendeplatten.

Sipariş Örneği/Ordering Example/Bestellbeispiel  
1 ad./pcs./stück ADKT-WGX16-R-1212-2-R12-K-S

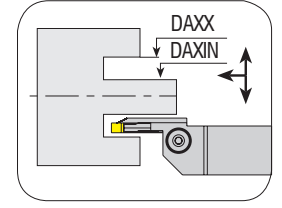
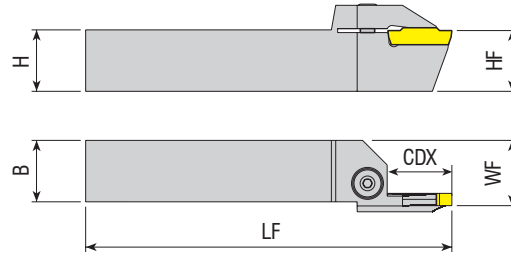

Takım Kodu Ordering Code Bestell-Bezeichnung	Stok Stock Lager		Takım Ölçüleri (mm) Dimension (mm) Abmessung (mm)							Kesici Uç Insert Wendeschneidplatte	Yedek Parçaları / Spare Parts / Ersatzteile		
	R	L	HF=H	B	LF	WF	CDX	DAXIN	DAXX		Sıkma Vidası Screw Klemmschraube	Pul Stamp Ring	Tork Anahtar Torx Key Torx-Innensechskantschlüssel
AAKT-K-R/L-2525-34-45-3-T17	●	●	25	25	150	26.5	17	34	45	MGM. - 3			
AAKT-K-R/L-2525-39-55-3-T17	●	●	25	25	150	26.5	17	39	55				
AAKT-K-R/L-2525-49-80-3-T17	●	●	25	25	150	26.5	17	49	80				
AAKT-K-R/L-2525-70-110-3-T17	●	●	25	25	150	26.5	17	70	110				
AAKT-K-R/L-2525-100-150-3-T17	●	●	25	25	150	26.5	17	100	150				
AAKT-K-R/L-2525-80-180-3-T32	●	●	25	25	150	26.5	32	80	180				
AAKT-K-R/L-2525-175-215-3-T22	●	●	25	25	150	26.5	22	175	215				
AAKT-K-R/L-2525-700-800-3-T17	●	●	25	25	150	26.5	17	700	800				
AAKT-K-R/L-2525-50-85-4-T22	●	●	25	25	150	26.5	22	50	85	MGM. - 4	2004-M8x1x20	-	AAL-05-4
AAKT-K-R/L-2525-70-110-4-T22	●	●	25	25	150	26.5	22	70	110				
AAKT-K-R/L-2525-100-150-4-T22	●	●	25	25	150	26.5	22	100	150				
AAKT-K-R/L-2525-80-180-4-T32	●	●	25	25	150	26.5	32	80	180				
AAKT-K-R/L-2525-180-800-4-T32	●	●	25	25	150	26.5	32	180	800	MGM. - 5			
AAKT-K-R/L-2525-70-110-5-T25	●	●	25	25	150	26.5	25	70	110				
AAKT-K-R/L-2525-100-150-5-T25	●	●	25	25	150	26.5	25	100	150				
AAKT-K-R/L-2525-80-180-5-T32	●	●	25	25	150	26.5	32	80	180				
AAKT-K-R/L-2525-140-200-5-T25	●	●	25	25	150	26.5	25	140	200				
AAKT-K-R/L-2525-180-800-5-T32	●	●	25	25	150	26.5	32	180	800	MGM. - 6			
new AAKT-K-R/L-2525-180-800-5-T40	●	○	25	25	150	26.5	40	180	800				
AAKT-K-R/L-2525-60-100-6-T25	●	●	25	25	150	26.5	25	60	100				
AAKT-K-R/L-2525-60-100-6-T35	●	○	25	25	150	26.5	35	60	100	MGM. - 6			
AAKT-K-R/L-2525-100-200-6-T25	●	○	25	25	150	26.5	25	100	200				
AAKT-K-R/L-2525-100-200-6-T35	●	○	25	25	150	26.5	35	100	200				
AAKT-K-R/L-2525-100-200-6-T45	●	○	25	25	150	26.5	45	100	200				
AAKT-K-R/L-2525-140-300-6-T35	●	●	25	25	150	26.5	35	140	300	MGM. - 8			
new AAKT-K-R/L-2525-180-360-6-T40	●	○	25	25	150	26.5	40	180	360				
AAKT-K-R/L-2525-140-300-8-T35	●	○	25	25	150	26.5	35	140	300	MGM. - 8			
AAKT-K-R/L-3232-140-350-8-T35	●	○	32	32	150	33.5	35	140	350				

R: Sağ / Right / Rechts L: Sol / Left / Links

● Stokta / In Stock / Auf Lager ○ Stokta Yok / Non Stock Item / Kein Lagerartikel, Lieferzeit auf Anfrage

KRLY Ucuna Uygunudur. / Compatible with KRLY Insert. / Kompatibel mit KRLY Wendeplatten.

Sipariş Örneği/Ordering Example/Bestellbeispiel

1 ad./pcs./stück AAKT-K-R-2525-34-45-3-T17

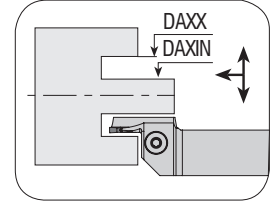
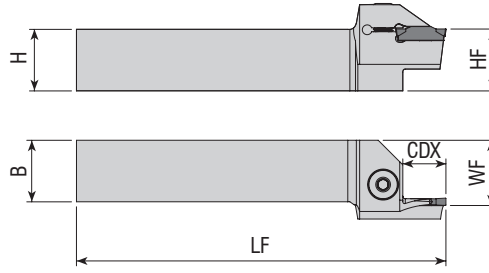

**Takım Kodu**  
**Ordering Code**  
**Bestell-Bezeichnung**

**Takım Ölçüleri (mm)**  
**Dimension (mm)**  
**Abmessung (mm)**

**Kesici Uç**  
**Insert**  
**Wendeschneidplatte**

**Yedek Parçaları / Spare Parts / Ersatzteile**

**Sıkma Vidası**  
**Screw**  
**Klemmschraube**

**Pul**  
**Stamp**  
**Ring**

**Anahtar**  
**Allen Key**  
**Innensechskantschlüssel**

R	L	HF=H	B	LF	WF	CDX	DAXIN	DAXX	Kesici Uç Insert Wendeschneidplatte	Sıkma Vidası Screw Klemmschraube	Pul Stamp Ring	Anahtar Allen Key Innensechskantschlüssel
●	○	25	25	150	26.5	4	140	180	Z.BD - 2	2004-M8x1x20	-	AAL-05-4
●	●	25	25	150	26.5	17	35	45	Z.FD - 3			
●	○	25	25	150	26.5	17	39	55				
●	●	25	25	150	26.5	17	49	80				
●	○	25	25	150	26.5	15	70	110	Z.GD - 4			
●	●	25	25	150	26.5	17	70	110				
●	●	25	25	150	26.5	17	100	150	Z.HD - 5			
●	●	25	25	150	26.5	22	100	150				
●	○	25	25	150	26.5	22	40	60				
●	●	25	25	150	26.5	22	52	80				
●	○	25	25	150	26.5	22	72	110	Z.KD - 6			
●	●	25	25	150	26.5	22	100	150				
●	○	25	25	150	26.5	25	55	95	Z.KD - 6			
●	●	25	25	150	26.5	25	85	140				
●	○	25	25	150	26.5	25	130	200				
●	●	25	25	150	26.5	25	190	400	Z.KD - 6			
●	○	25	25	150	26.5	35	190	400				
●	●	25	25	150	26.5	17	200	500	Z.KD - 6			
●	○	25	25	150	26.5	15	60	110				
●	○	32	32	170	33.5	25	160	400	Z.KD - 6			

ZCC Ucuna Uygundur. / Compatible with ZCC Insert. / Kompatibel mit ZCC Wendeplatten.

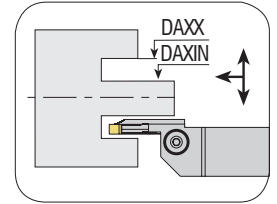
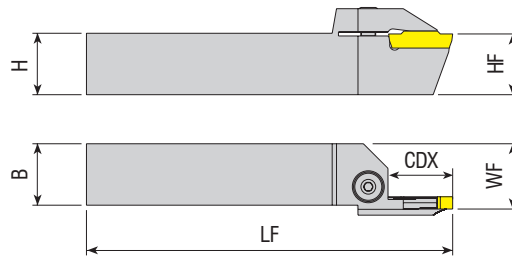

**Takım Kodu**  
**Ordering Code**  
**Bestell-Bezeichnung**

**Stok**  
**Stock**  
**Lager**

**Takım Ölçüleri (mm)**  
**Dimension (mm)**  
**Abmessung (mm)**

**Kesici Uç**  
**Insert**  
**Wendeschneidplatte**

**Yedek Parçaları / Spare Parts / Ersatzteile**

**Sıkma Vidası**  
**Screw**  
**Klemmschraube**

**Pul**  
**Stamp**  
**Ring**

**Anahtar**  
**Allen Key**  
**Innensechskantschlüssel**

R	L	HF=H	B	LF	WF	CDX	DAXIN	DAXX	Kesici Uç Insert Wendeschneidplatte	Sıkma Vidası Screw Klemmschraube	Pul Stamp Ring	Anahtar Allen Key Innensechskantschlüssel
○	○	25	25	150	26.5	22	44	70	KG. - 4	2004-M8x1x20	-	AAL-05-4
○	○	25	25	150	26.5	22	60	120				
○	○	25	25	150	26.5	22	112	200				

R: Sağ / Right / Rechts L: Sol / Left / Links

● Stokta / In Stock / Auf Lager ○ Stokta Yok / Non Stock Item / Kein Lagerartikel, Lieferzeit auf Anfrage

KRLY Ucuna Uygundur. / Compatible with KRLY Insert. / Kompatibel mit KRLY Wendeplatten.

Sipariş Örneği/Ordering Example/Bestellbeispiel  
1 ad./pcs./stück AAKT-ZCC2-R-2525-140-180-2-T4

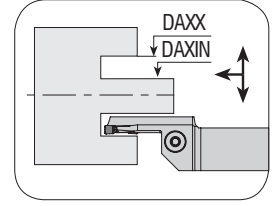
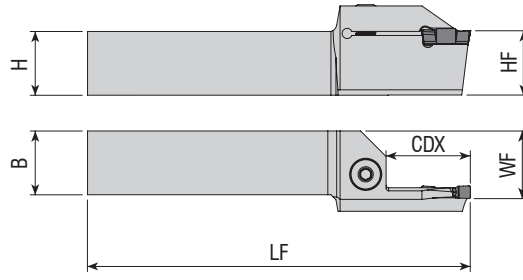

Takım Kodu Ordering Code Bestell-Bezeichnung	Stok Stock Lager		Takım Ölçüleri (mm) Dimension (mm) Abmessung (mm)							Kesici Uç Insert Wendeschneidplatte	Yedek Parçaları / Spare Parts / Ersatzteile			
	R	L	HF=H	B	LF	WF	CDX	DAXIN	DAXX		Sıkma Vidası Screw Klemmschraube	Pul Stamp Ring	Anahtar Allen Key Innensechskantschlüssel	
AAKT-IG-R/L-2525-40-60-4-T25	●	●	25	25	150	26.5	25	40	60	DGN / GRP - 4	2004-M8x1x20	-	AAL-05-4	
AAKT-IG-R/L-2525-52-80-4-T25	●	●	25	25	150	26.5	25	52	80					
AAKT-IG-R/L-2525-70-110-4-T28	●	●	25	25	150	26.5	28	70	110					
AAKT-IG-R/L-2525-72-110-4-T25	○	○	25	25	150	26.5	25	72	110					
AAKT-IG-R/L-2525-100-150-4-T25	●	○	25	25	150	26.5	25	100	150					
AAKT-IG-R/L-2525-110-200-4-T28	●	○	25	25	150	26.5	28	110	200					
AAKT-IG-R/L-2525-110-200-4-T32	●	●	25	25	150	26.5	32	110	200					
AAKT-IG-R/L-2525-140-200-4-T25	○	○	25	25	150	26.5	25	140	200					
AAKT-IG-R/L-2525-180-800-4-T28	●	●	25	25	150	26.5	28	180	800					
AAKT-IG-R/L-2525-200-800-4-T25	○	○	25	25	150	26.5	25	200	800					
AAKT-IG-R/L-2525-70-110-5-T32	●	●	25	25	150	26.5	32	70	110	DGN / GRP - 5	-	AAL-05-4		
AAKT-IG-R/L-2525-110-200-5-T9	●	○	25	25	150	26.5	9	110	200					
AAKT-IG-R/L-2525-110-200-5-T32	●	●	25	25	150	26.5	32	110	200					
AAKT-IG-R/L-2525-180-800-5-T32	●	●	25	25	150	26.5	32	180	800	DGN / GRP - 6	-	AAL-05-4		
AAKT-IG-R/L-2525-58-100-6-T32	●	○	25	25	150	26.5	32	58	100					
AAKT-IG-R/L-2525-88-180-6-T32	●	○	25	25	150	26.5	32	88	180					

ISCR Ucuna Uygundur. / Compatible with ISCR Insert. / Kompatibel mit ISCR Wendeplatten.

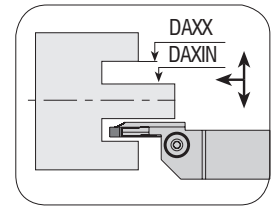
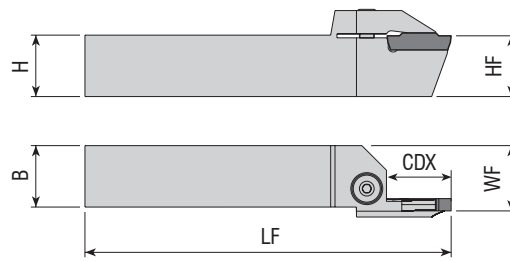

Takım Kodu Ordering Code Bestell-Bezeichnung	Stok Stock Lager		Takım Ölçüleri (mm) Dimension (mm) Abmessung (mm)							Kesici Uç Insert Wendeschneidplatte	Yedek Parçaları / Spare Parts / Ersatzteile			
	R	L	HF=H	B	LF	WF	CDX	DAXIN	DAXX		Sıkma Vidası Screw Klemmschraube	Pul Stamp Ring	Anahtar Allen Key Innensechskantschlüssel	
AAKT-SGC-R/L-2020-22-53-3-T13	○	●	20	20	125	21.5	13	22	53	GCM N3002 GCM N4020	2004-M8X1X20	-	AAL-05-4	
AAKT-SGC-R/L-2525-80-100-3-T8	●	○	25	25	150	26.5	8	80	100					
AAKT-SGC-R/L-2525-40-65-4-T12	●	○	25	25	150	26.5	12	40	65					
AAKT-SGC-R/L-2525-80-140-4-T8	●	○	25	25	150	26.5	8	80	140					

R: Sağ / Right / Rechts L: Sol / Left / Links

● Stokta / In Stock / Auf Lager ○ Stokta Yok / Non Stock Item / Kein Lagerartikel, Lieferzeit auf Anfrage

SMTM Ucuna Uygundur. / Compatible with SMTM Insert. / Kompatibel mit SMTM Wendeplatten.

Sipariş Örneği/Ordering Example/Bestellbeispiel

1 ad./pcs./stück AAKT-IG-R-2525-40-60-4-T25

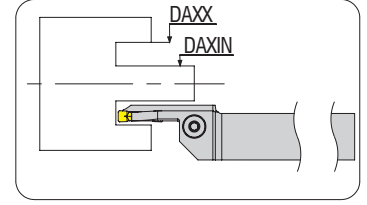
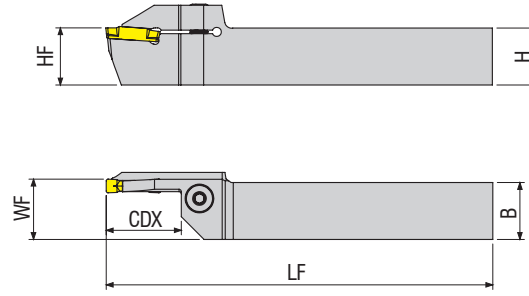
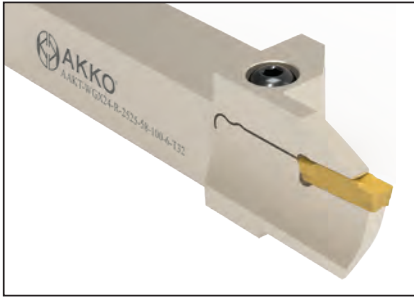

**Takım Kodu**  
**Ordering Code**  
*Bestell-Bezeichnung*

Stok Stock Lager	Takım Ölçüleri (mm) Dimension (mm) Abmessung (mm)									Kesici Uç Insert Wendeschneidplatte	Yedek Parçaları / Spare Parts / Ersatzteile		
	R	L	HF=H	B	LF	WF	CDX	DAXIN	DAXX		Sıkma Vidası Screw Klemmschraube	Pul Stamp Ring	Anahtar Allen Key Innensechskantschlüssel
AAKT-WGX24-R-L-2525-58-100-6-T32	●	○	25	25	170	26.5	32	58	100	GX24-6	2004-M8x1x20	-	AAL-05-4
AAKT-WGX24-R-L-2525-88-180-6-T32	●	○	25	25	170	26.5	32	88	180				

WLTR Ucuna Uygundur. / Compatible with WLTR Insert. / Kompatibel mit WLTR Wendeplatten.

L TİP ALIN KANAL AÇMA TAKIMLARI  
L TYPE FACE EXTERNAL GROOVING TOOLHOLDERS  
AXIAL-STECHHALTER L-TYPE

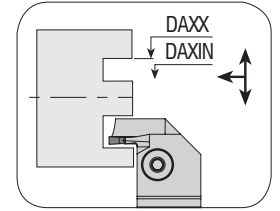
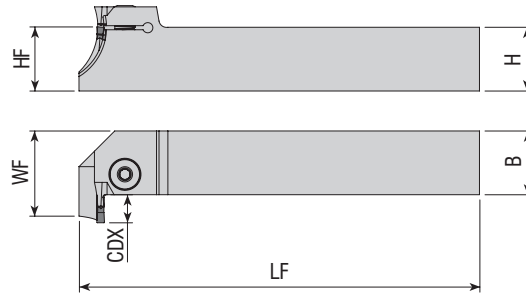

**Takım Kodu**  
**Ordering Code**  
*Bestell-Bezeichnung*

Stok Stock Lager	Takım Ölçüleri (mm) Dimension (mm) Abmessung (mm)									Kesici Uç Insert Wendeschneidplatte	Yedek Parçaları / Spare Parts / Ersatzteile		
	R	L	HF=H	B	LF	WF	CDX	DAXIN	DAXX		Sıkma Vidası Screw Klemmschraube	Pul Stamp Ring	Anahtar Allen Key Innensechskantschlüssel
ALKT-ZCC2-R/L-2525-35-45-3-T10	●	●	25	25	150	36	10	35	45	Z.FD - 3	2004-M8x1x20	-	AAL-05-4
ALKT-ZCC2-R/L-2525-39-55-3-T10	●	●	25	25	150	36	10	39	55				
ALKT-ZCC2-R/L-2525-35-∞-3-T4	●	●	25	25	150	30	4	35	∞	Z.GD - 4	2004-M8x1x20	-	AAL-05-4
ALKT-ZCC2-R/L-2525-40-60-4-T14	●	●	25	25	150	40	14	40	60				
ALKT-ZCC2-R/L-2525-52-80-4-T14	●	○	25	25	150	40	14	52	80	Z.GD - 4	2004-M8x1x20	-	AAL-05-4
ALKT-ZCC2-R/L-2525-72-110-4-T14	●	○	25	25	150	40	14	72	110				
ALKT-ZCC2-R/L-2525-100-230-4-T14	●	○	25	25	150	40	14	100	230	Z.GD - 4	2004-M8x1x20	-	AAL-05-4
ALKT-ZCC2-R/L-2525-40-∞-4-T4	●	●	25	25	150	30	4	40	∞				

R: Sağ / Right / Rechts L: Sol / Left / Links

● Stokta / In Stock / Auf Lager ○ Stokta Yok / Non Stock Item / Kein Lagerartikel, Lieferzeit auf Anfrage

ZCC Ucuna Uygundur. / Compatible with ZCC Insert. / Kompatibel mit ZCC Wendeplatten.

Sipariş Örneği/Ordering Example/Bestellbeispiel  
1 ad./pcs./stück AAKT-WGX24-R-2525-58-100-6-T32

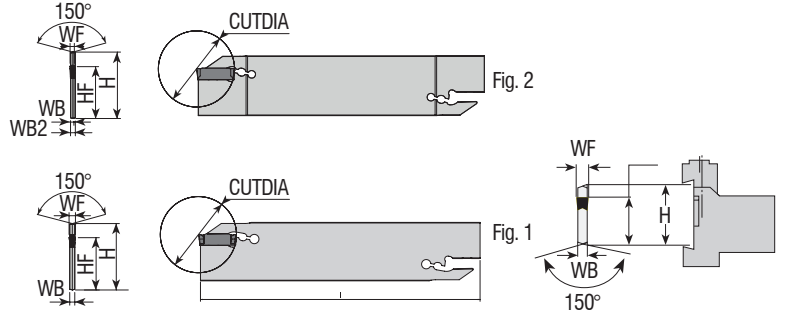

Takım Kodu Ordering Code Bestell-Bezeichnung	Stok Stock Lager	Takım Ölçüleri (mm) Dimension (mm) Abmessung (mm)								Kesici Uç Insert Wendeschneidplatte	Yedek Parçaları / Spare Parts Ersatzteile
		H	WF	WB2	WB	I	HF	CUTDIA	Fig.		
AKL-SGC-26-3	●	26	3	2.40	-	110	21.4	39	2	GCM N30	ALA-02
AKL-SGC-32-3	●	32	3	2.40	-	150	25	39	1		

SMTM Ucuna Uygunur. / Compatible with SMTM Insert. / Kompatibel mit SMTM Wendeleplatten.

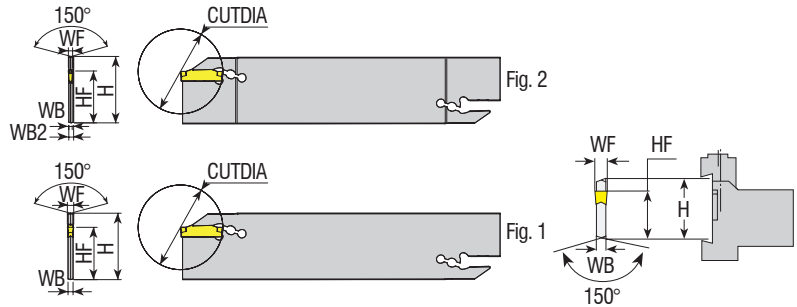

Takım Kodu Ordering Code Bestell-Bezeichnung	Stok Stock Lager	Takım Ölçüleri (mm) Dimension (mm) Abmessung (mm)								Kesici Uç Insert Wendeschneidplatte	Yedek Parçaları / Spare Parts Ersatzteile
		H	WF	WB2	WB	I	HF	CUTDIA	Fig.		
AKL-TD-32-2	●	32	2	2.4	1.6	150	25	39	2	TD. - 2	ALA-02
✎ AKL-TD-26-3	●	26	3	-	2.40	150	26	40	1	TD. - 3	
AKL-TD-32-3	●	32	3	2.4	-	150	25	39	1	TD. - 4	
✎ AKL-TD-26-4	●	26	4	-	3.20	150	26	40	1	TD. - 5	
✎ AKL-TD-32-5	●	32	5	-	4	150	25	40	1		

R: Sağ / Right / Rechts L: Sol / Left / Links

● Stokta / In Stock / Auf Lager ○ Stokta Yok / Non Stock Item / Kein Lagerartikel, Lieferzeit auf Anfrage  
TGTC Ucuna Uygunur. / Compatible with TGTC Insert. / Kompatibel mit TGTC Wendeleplatten.

Sipariş Örneği/Ordering Example/Bestellbeispiel

1 ad./pcs./stück AKL-SGC-26-3

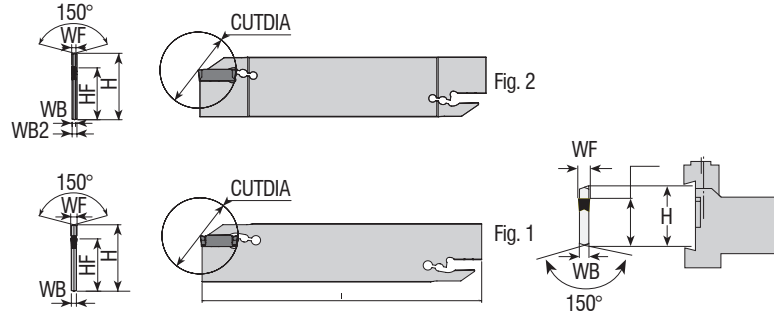

Takım Kodu Ordering Code Bestell-Bezeichnung	Stok Stock Lager	Takım Ölçüleri (mm) Dimension (mm) Abmessung (mm)								Kesici Uç Insert Wendeschneidplatte	Yedek Parçaları / Spare Parts Ersatzteile	
		H	WF	WB2	WB	I	HF	CUTDIA	Fig.		Anahtar Allen Key Innensechskantschlüssel	
AKL-I-26-2	●	26	1.9-2.5	1.6	-	110	21.4	39	1	DGN - 2	ALA-02	
AKL-I-32-2	●	32	1.9-2.5	1.6	2.4	150	25	39	2			
AKL-I-26-3	●	26	3-3.18	2.4	-	110	21.4	39	1	DGN - 3	ALA-02	
AKL-I-32-3	●	32	3-3.18	2.4	-	150	25	39	1			
AKL-I-26-4	●	26	4	3.2	-	110	21.4	80	1	DGN / GRP - 4	ALA-02	
AKL-I-32-4	●	32	4	3.2	-	150	25	100	1			

ISCR Ucuna Uygun. / Compatible with ISCR Insert. / Kompatibel mit ISCR Wendepplatten.

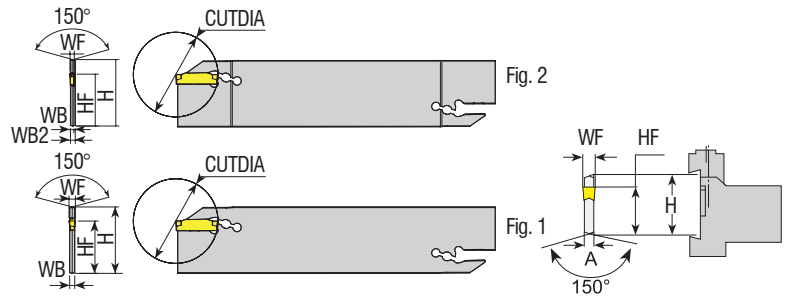

Takım Kodu Ordering Code Bestell-Bezeichnung	Stok Stock Lager	Takım Ölçüleri (mm) Dimension (mm) Abmessung (mm)								Kesici Uç Insert Wendeschneidplatte	Yedek Parçaları / Spare Parts Ersatzteile	
		H	WF	WB2	WB	I	HF	CUTDIA	Fig.		Anahtar Allen Key Innensechskantschlüssel	
AKL-123-32-2	●	32	2	2.4	1.6	150	25	39	2	123 - 2 123 - 3 123 - 4	ALA-02	
AKL-123-32-3	●	32	3	2.4	-	150	25	39	1			
AKL-123-32-4	●	32	4	3.2	-	150	25	39	1			

R: Sağ / Right / Rechts L: Sol / Left / Links

● Stokta / In Stock / Auf Lager ○ Stokta Yok / Non Stock Item / Kein Lagerartikel, Lieferzeit auf Anfrage  
SNDVK Ucuna Uygun. / Compatible with SNDVK Insert. / Kompatibel mit SNDVK Wendepplatten.

Sipariş Örneği/Ordering Example/Bestellbeispiel  
1 ad./pcs./stück AKL-I-26-2

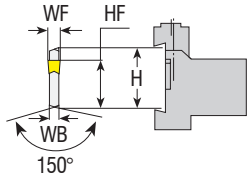
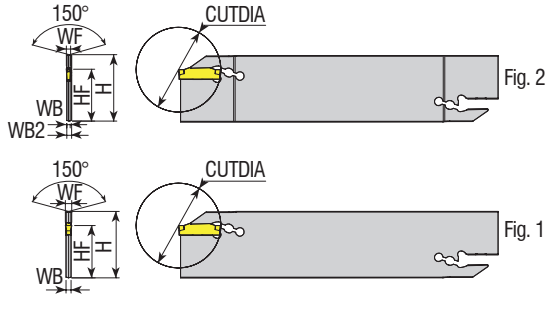
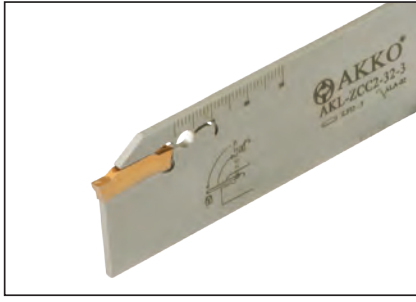

Takım Kodu Ordering Code Bestell-Bezeichnung	Stok Stock Lager	Takım Ölçüleri (mm) Dimension (mm) Abmessung (mm)								Kesici Uç Insert Wendeschneidplatte	Yedek Parçaları / Spare Parts Ersatzteile	Anahtar Allen Key Innensechskantschlüssel
		H	WF	WB2	WB	I	HF	CUTDIA	Fig.			
AKL-ZCC2-32-3	●	32	3	-	2.40	150	25	39	1	Z.FD-3	ALA-02	
AKL-ZCC2-32-4	●	32	4	-	3.20	150	25	50.8	1	Z.FD-4		
AKL-ZCC2-32-5	●	32	5	-	4	150	25	50.8	1	Z.FD-5		

ZCC Ucuna Uygun. / Compatible with ZCC Insert. / Kompatibel mit ZCC Wendepplatten.

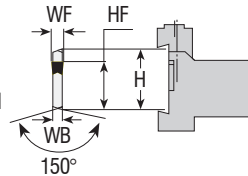
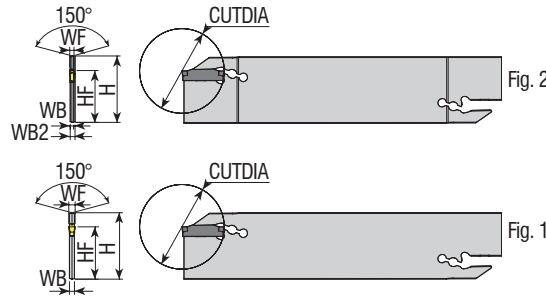

Takım Kodu Ordering Code Bestell-Bezeichnung	Stok Stock Lager	Takım Ölçüleri (mm) Dimension (mm) Abmessung (mm)								Kesici Uç Insert Wendeschneidplatte	Yedek Parçaları / Spare Parts Ersatzteile	Anahtar Allen Key Innensechskantschlüssel
		H	WF	WB2	WB	I	HF	CUTDIA	Fig.			
AKL-K-32-2	●	32	2	2.40	1.60	150	25	32	2	MGM.-2	ALA-02	
AKL-K-32-3	●	32	3	-	2.40	150	25	42	1	MGM.-3		
AKL-K-32-4	●	32	4	-	3.20	150	25	42	1	MGM.-4		

R: Sağ / Right / Rechts L: Sol / Left / Links  
 ● Stokta / In Stock / Auf Lager ○ Stokta Yok / Non Stock Item / Kein Lagerartikel, Lieferzeit auf Anfrage  
 KRLY Ucuna Uygun. / Compatible with KRLY Insert. / Kompatibel mit KRLY Wendepplatten.

Sipariş Örneği/Ordering Example/Bestellbeispiel  
 1 ad./pcs./stück AKL-ZCC2-32-3





new

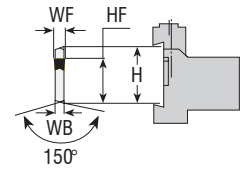
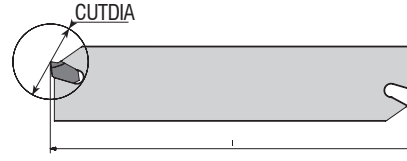
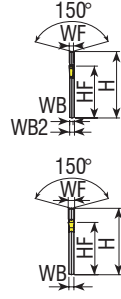

Takım Kodu Ordering Code Bestell-Bezeichnung	Stok Stock Lager	Takım Ölçüleri (mm) Dimension (mm) Abmessung (mm)								Kesici Uç Insert Wendeschneidplatte	Yedek Parçaları / Spare Parts Ersatzteile	
		H	WF	WB2	WB	I	HF	CUTDIA	Fig.		Anahtar Allen Key Innensechskantschlüssel	
AKL-SP-26-2	●	26	2	-	1.60	150	21	-	1	SP200N	ALA-03	
AKL-SP-26-3	●	26	3	-	2.40	150	21	-	1	SP300N		
AKL-SP-32-3	●	32	3	-	2.40	150	25	-	1	SP300N		
AKL-SP-32-4	●	32	4	-	3.20	150	25	-	1	SP400N		

KRLY Ucuna Uygun. / Compatible with KRLY Insert. / Kompatibel mit KRLY Wendeplatten.

new

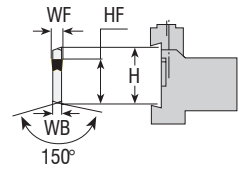
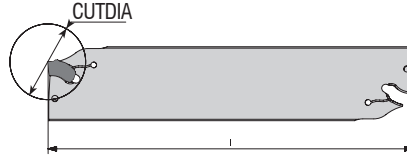
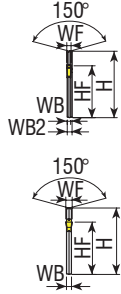

Takım Kodu Ordering Code Bestell-Bezeichnung	Stok Stock Lager	Takım Ölçüleri (mm) Dimension (mm) Abmessung (mm)								Kesici Uç Insert Wendeschneidplatte	Yedek Parçaları / Spare Parts Ersatzteile	
		H	WF	WB2	WB	I	HF	CUTDIA	Fig.		Anahtar Allen Key Innensechskantschlüssel	
AKL-SX-32-3	●	32	3	-	2.40	150	24.50	-	2	SX-3E.300N	ALA-04	
AKL-SX-32-4	●	32	4	-	3.40	150	24.50	-	2	SX-4E.400N		
AKL-SX-32-5	●	32	5	-	4.30	150	24.40	-	2	SX-5E.500N		
AKL-SX-32-6	●	32	6	-	5.30	150	24.30	-	2	SX-5E.600N		

R: Sağ / Right / Rechts L: Sol / Left / Links

● Stokta / In Stock / Auf Lager ○ Stokta Yok / Non Stock Item / Kein Lagerartikel, Lieferzeit auf Anfrage  
WLTR Ucuna Uygun. / Compatible with WLTR Insert. / Kompatibel mit WLTR Wendeplatten.

Sipariş Örneği/Ordering Example/Bestellbeispiel

1 ad./pcs./stück AKL-SP-26-2

➤ **KESME VE DERİN KANAL AÇMA LAMA BLOĞU**  
**BLOCKS FOR PARTING AND DEEP GROOVING BLADES**  
**SPANNBLOCK FÜR STECHSCHWERT**

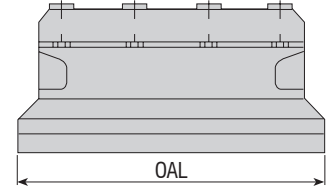
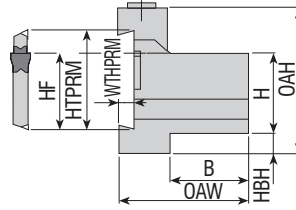

Takım Kodu Ordering Code Bestell-Bezeichnung	Stok Stock Lager	Takım Ölçüleri (mm) Dimension (mm) Abmessung (mm)									Yedek Parçaları / Spare Parts / Ersatzteile		
		HTPRM	HF	H	HBH	OAH	WTHPRM	OAL	B	OAW	Pabuç Clamp Spannspratze	Pabuç Vidası Clamp Screw Klemmschraube	Anahtar Allen Key Innensechskantschlüssel
ALBU-20-26	●	26	21.4	20	9	43	4	86	19	38	ABK-01	2505-M6x25	AAL-07-5
ALBU-25-26	●	26	21.4	25	5	45	4	110	23	42	ABK-02	2505-M6x30	
ALBU-20-32	●	32	25	20	13	50	5.3	100	19	38	ABK-03		
ALBU-25-32	●	32	25	25	8	50	5.3	110	23	42	ABK-04		
ALBU-32-32	●	32	25	32	5	54	5.3	110	29	48			

**İÇTEN SU VERME KANALLI KESME VE DERİN KANAL AÇMA LAMA BLOĞU**  
**BLOCK FOR PARTING&GROOVING TOOLS WITH INTERNAL COOLANT HOLE**  
**BLOCK FÜR TEILUNG&AUSHOLUNG MIT INNEN KÜHLUNG**

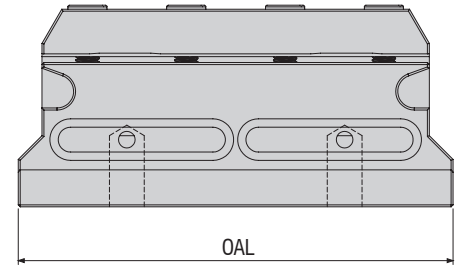
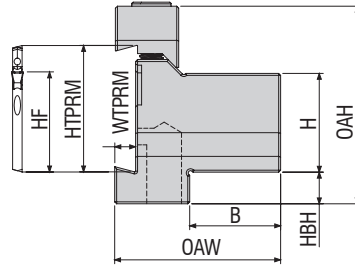

Takım Kodu Ordering Code Bestell-Bezeichnung	Stok Stock Lager	Takım Ölçüleri (mm) Dimension (mm) Abmessung (mm)									Yedek Parçaları / Spare Parts / Ersatzteile		
		HTPRM	HD	H	HBH	AOH	WTHPRM	OAL	B	OAW	Pabuç Clamp Spannspratze	Pabuç Vidası Clamp Screw Klemmschraube	Anahtar Allen Key Innensechskantschlüssel
ALBU-20-32-H	●	32	20	20	13	36.50	5.30	100	19	38	ABK-03	2505-M6x30	AAL-07-5
ALBU-25-32-H	●	32	25	25	8	50	5.30	110	23	42	ABK-01		
ALBU-32-32-H	●	32	32	32	5	40.50	5.30	110	29	48	ABK-04		

R: Sağ / Right / Rechts L: Sol / Left / Links

● Stokta / In Stock / Auf Lager ○ Stokta Yok / Non Stock Item / Kein Lagerartikel, Lieferzeit auf Anfrage

Sipariş Örneği/Ordering Example/Bestellbeispiel  
1 ad./pcs./stück ALBU-20-26

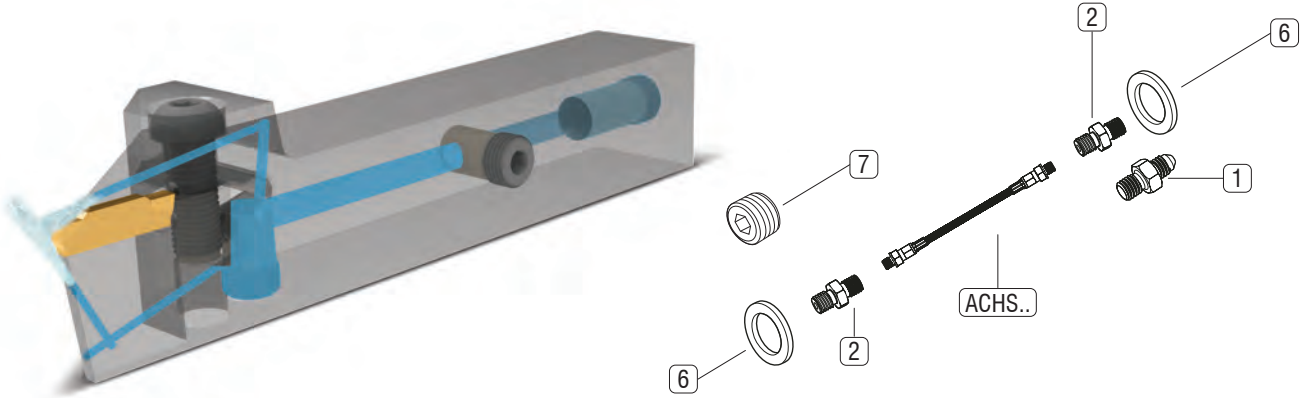

Not: İçten soğutmalı tüm torna katerlerinde kullanılacak 3 tip soğutma hortum setleri tasarlanmıştır. Takımların kullanılmasından önce, kullanılmayan bağlantıların set içindeki vida ile kapatılarak sızdırmazlığın sağlanmasına dikkat edilmelidir. Torna katerlerine yönelik soğutma hortum setleri, ACHS... 10 bar ile maksimum 275 bar basınç aralığında kullanılabilir.

Note: 3 types of cooling hose sets are designed that can be used in all internally cooled lathes. Before using the tools, care should be taken to ensure that the unused connections are closed with the screw in the set and that sealing is ensured. Cooling hose sets for lathe tools can be used in the pressure range of ACHS ... 10 bar to max 275 bar.

Note: Es wurden 3 Arten von Kühlschlauch-Sets entwickelt, die in allen intern gekühlten Drehmaschinen verwendet werden können. Vor der Verwendung der Werkzeuge sollte darauf geachtet werden, dass die nicht verwendeten Verbindungen mit der Schraube im Satz geschlossen werden und die Abdichtung gewährleistet ist. Kühlschlauchsätze für Drehmaschinen können im Druckbereich von ACHS ... 10 bar bis max. 275 bar eingesetzt werden.

Set İçindeki Parçalar Parts In The Set Teile im Set				Uzunluk / Length Code / Länge Einstellen: 250		
				Set Kodu: Set Code: Code Einstellen:	ACHS-1-250	Set Kodu: Set Code: Code Einstellen:
1		AMP-01	M10 Bağlantı Elemanı M10 Fastener M10 Verschluss	1x	-	-
2		AMP-02	G 1/8" Çift Bağlantı Elemanı G 1/8" Double Fastener G 1/8" Doppelverschluss	2x	1x	-
3		AMP-03	G 1/8" Açılı Bağlantısı G 1/8" Angle Connection G 1/8" Winkelverbindung	-	1x	2x
4		AMP-04	M10" Açılı Bağlantısı M10" Angle Connection M10" Winkelverbindung	-	1x	1x
5		AMP-05	G1/4"-G1/8" Kılcalma Parçası G1 / 4"-G1/8" Capillary Piece G1 / 4"-G1/8" Kapillarstück	-	1x	1x
6		AG-01	Bakır Conta Copper Gasket Kupferdichtung	2x	3x	4x
7		2705-G1/8-5.5	G1/8" Sızdırmaz Civata G1/8" Sealing Bolt G1/8" Dichtungsschraube	1x	1x	1x
8		AH-1-250	Hortum Hose Schlauch	1x	-	-
9		AH-2-250	Hortum Hose Schlauch	-	1x	-
10		AH-3-250	Hortum Hose Schlauch	-	-	1x

**konuşulan**  
**the spoken** kalite...  
**quality...**



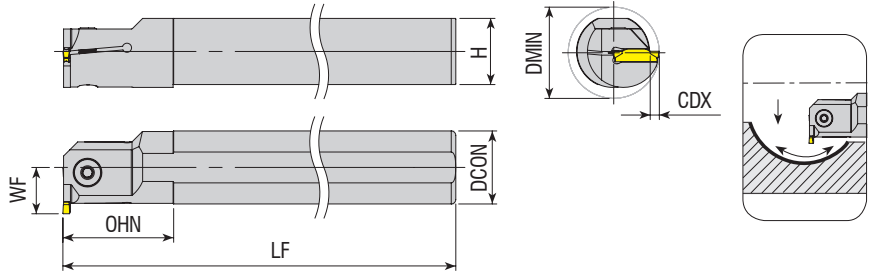

Takım Kodu Ordering Code Bestell-Bezeichnung	Stok Stock Lager		Takım Ölçüleri (mm) Dimension (mm) Abmessung (mm)							Kesici Uç Insert Wendeschneitplatte	Yedek Parçaları / Spare Parts / Ersatzteile	
	R	L	DCON	DMIN	LF	OHN	CDX	H	WF		Sıkma Vidası Screw Klemmschraube	Anahtar Allen Key Innensechskantschlüssel
AIKT-K-R/L-16-2-T4	●	●	16	21	150	28	4	14.8	12	MGM. - 2	2503-M4x10	AAL-03-3
AIKT-K-R/L-20-2-T4	●	●	20	25	170	30	4	18.3	14		2503-M4x12	
AIKT-K-R/L-25-2-T6	●	●	25	32	200	40	6	23	18.5		2504-M5x12	
AIKT-K-R/L-20-3-T6	●	●	20	27	170	30	6	18.3	16	MGM. - 3	2504-M5x12	AAL-05-4
AIKT-K-R/L-20-3-T7	●	●	20	25	170	38	7	18.3	13		2504-M5x16	
AIKT-K-R/L-25-3-T6	●	●	25	32	200	40	6	23	18.5		2504-M5x16	
AIKT-K-R/L-25-3-T10	●	●	25	32	200	48	10	23	17		2004-M8x1x20	
AIKT-K-R/L-32-3-T6	●	●	32	39	250	50	6	30	22		2504-M5x12	
AIKT-K-R/L-32-3-T12	●	●	32	39	250	53	12	30	22		2504-M5x16	
AIKT-K-R/L-40-3-T6	●	●	40	47	300	55	6	37.5	26		2004-M8x1x20	
AIKT-K-R/L-40-3-T12	●	○	40	48	300	63	12	37.5	27	2004-M8x1x20		
AIKT-K-R/L-20-4-T6	●	●	20	27	170	30	6	18.3	16	MGM. - 4	2504-M5x12	AAL-05-4
AIKT-K-R/L-20-4-T7	●	○	20	25	170	38	7	18.3	13		2504-M5x16	
AIKT-K-R/L-25-4-T6	●	●	25	32	200	40	6	23	18.5		2504-M5x16	
AIKT-K-R/L-25-4-T10	●	●	25	32	200	49	10	23	17		2004-M8x1x20	
AIKT-K-R/L-32-4-T6	●	●	32	39	250	50	6	30	22		2504-M5x16	
AIKT-K-R/L-32-4-T12	●	●	32	39	250	53	12	30	22		2004-M8x1x20	
AIKT-K-R/L-40-4-T6	●	●	40	47	300	55	6	37.5	26		2504-M5x16	
AIKT-K-R/L-40-4-T12	●	●	40	48	300	63	12	37.5	27	2004-M8x1x20		
AIKT-K-R/L-25-5-T7	●	●	25	33	200	40	7	23	19.5	MGM. - 5	2504-M5x16	AAL-05-4
AIKT-K-R/L-32-5-T7	●	●	32	40	250	50	7	30	23		2004-M8x1x20	
AIKT-K-R/L-40-5-T7	●	●	40	48	300	55	7	37.5	27		2004-M8x1x20	
AIKT-K-R/L-40-5-T12	●	○	40	48	300	63	12	37.5	27		2004-M8x1x20	

R: Sağ / Right / Rechts L: Sol / Left / Links  
● Stokta / In Stock / Auf Lager ○ Stokta Yok / Non Stock Item / Kein Lagerartikel, Lieferzeit auf Anfrage  
KRLY Ucuna Uygunudur. / Compatible with KRLY Insert. / Kompatibel mit KRLY Wendeplatten.

Sipariş Örneği/Ordering Example/Bestellbeispiel  
1 ad./pcs./stück AIKT-K-R-16-2-T4

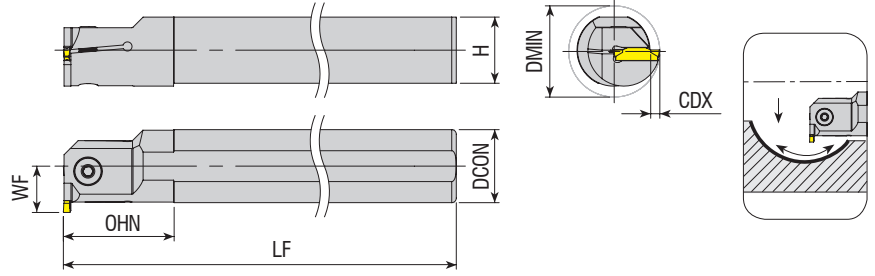

Takım Kodu Ordering Code Bestell-Bezeichnung	Stok Stock Lager		Takım Ölçüleri (mm) Dimension (mm) Abmessung (mm)							Kesici Uç Insert Wendeschneidplatte	Yedek Parçaları / Spare Parts / Ersatzteile	
	R	L	DCON	DMIN	LF	OHN	CDX	H	WF		Sıkma Vidası Screw Klemmschraube	Anahtar Allen Key Innensechskantschlüssel
AIKT-KG-R/L-25-2-T7	●	●	25	33	200	40	7	23	19.5	KG.. - 2	2504-M5x12	AAL-05-4
AIKT-KG-R/L-20-3-T6.5-H	●	○	20	27.5	170	30	6.5	18.3	16.5		2504-M5x16	
AIKT-KG-R/L-25-3-T7	○	○	25	33	200	40	7	23	19.5	KG.. - 3	2004-M8x1x20	
AIKT-KG-R/L-40-3-T8	●	○	40	50	300	55	8	37.5	28		2504-M5x16	
AIKT-KG-R/L-25-4-T8	●	●	25	34	200	40	8	23	20.5	KG.. - 4		

KRLY Ucuna Uygunur. / Compatible with KRLY Insert. / Kompatibel mit KRYL

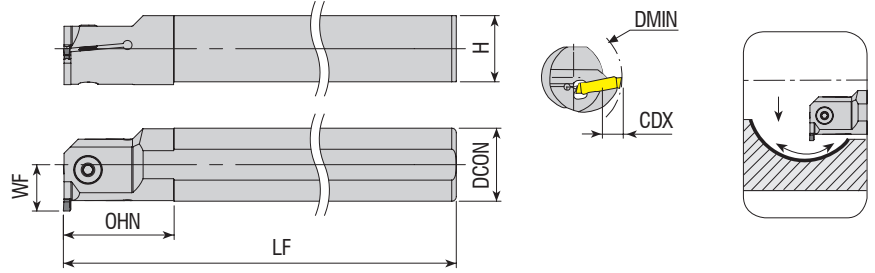

Takım Kodu Ordering Code Bestell-Bezeichnung	Stok Stock Lager		Takım Ölçüleri (mm) Dimension (mm) Abmessung (mm)							Kesici Uç Insert Wendeschneidplatte	Yedek Parçaları / Spare Parts / Ersatzteile	
	R	L	DCON	DMIN	LF	OHN	CDX	H	WF		Sıkma Vidası Screw Klemmschraube	Anahtar Allen Key Innensechskantschlüssel
AIKT-H-R/L-25-3-T8	●	●	25	34	200	40	8	23	20.5	S229 - 3	2504-M5x16	AAL-05-4
AIKT-H-R/L-32-3-T7	●	●	32	40	250	50	7	30	23		2004-M8x1x20	
AIKT-H-R/L-40-3-T7	●	●	40	48	300	55	7	37.5	27			
AIKT-H-R/L-25-4-T8	●	●	25	34	200	40	8	23	20.5	S229 - 4	2504-M5x16	
AIKT-H-R/L-32-4-T7	●	●	32	40	250	50	7	30	23		2004-M8x1x20	
AIKT-H-R/L-40-4-T7	●	●	40	48	300	55	7	37.5	27			
AIKT-H-R/L-25-5-T8	●	●	25	34	200	40	8	23	20.5	S229 - 5	2504-M5x16	
AIKT-H-R/L-32-5-T7	●	○	32	40	250	50	7	30	23		2004-M8x1x20	
AIKT-H-R/L-40-5-T7	●	○	40	48	300	55	7	37.5	27			

R: Sağ / Right / Rechts L: Sol / Left / Links  
● Stokta / In Stock / Auf Lager ○ Stokta Yok / Non Stock Item / Kein Lagerartikel, Lieferzeit auf Anfrage  
HRN Ucuna Uygunur. / Compatible with HRN Insert. / Kompatibel mit HRN Wendeleisten.

Sipariş Örneği/Ordering Example/Bestellbeispiel  
1 ad./pcs./stück Aikt-KG-R-25-2-T7

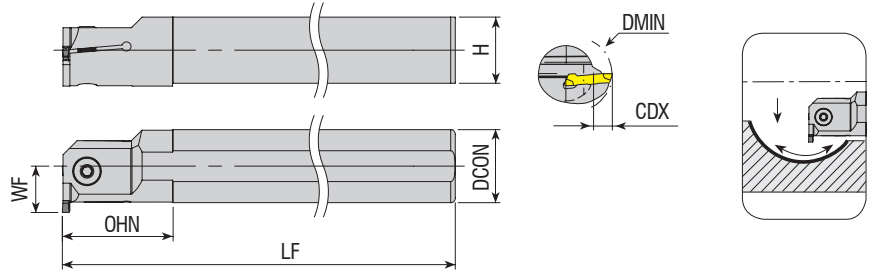

Takım Kodu Ordering Code Bestell-Bezeichnung	Stok Stock Lager		Takım Ölçüleri (mm) Dimension (mm) Abmessung (mm)						Kesici Uç Insert Wendeschneidplatte	Yedek Parçaları / Spare Parts / Ersatzteile		
	R	L	DCON	DMIN	LF	OHN	CDX	H		WF	Sıkma Vidası Screw Klemmschraube	Anahtar Allen Key Innensechskantschlüssel
AIKT-HK-R/L-20-2-T6	●	●	20	26	170	30	6	18.3	16	S224 - 2	2503-M4x12	AAL-03-3
AIKT-HK-R/L-25-2-T6	●	○	25	32	200	40	6	23	18.5		2504-M5x16	AAL-05-4
AIKT-HK-R/L-20-3-T6	●	○	20	27	170	30	6	18.3	16	S224 - 3	2504-M5x12	
AIKT-HK-R/L-25-3-T6	●	●	25	32	200	40	6	23	18.5		2504-M5x16	
AIKT-HK-R/L-32-3-T6	●	●	32	39	250	50	6	30	22	S224 - 4	2004-M8x1x20	AAL-05-4
AIKT-HK-R/L-20-4-T6	●	○	20	27	170	30	6	18.3	16		2504-M5x12	
AIKT-HK-R/L-25-4-T6	●	○	25	32	200	40	6	23	18.5	S224 - 4	2504-M5x16	AAL-05-4
AIKT-HK-R/L-32-4-T6	●	○	32	39	250	50	6	30	22		2004-M8x1x20	
AIKT-HS223-R/L-20-2-T5	●	○	20	26	170	33	5	18.3	15	S223 - 2	2503-M4x12	AAL-03-3
AIKT-HS223-R/L-25-2-T5	●	○	25	31	200	40	5	23	17.5		2504-M5x16	AAL-05-4
AIKT-HS223-R/L-20-3-T6	●	○	20	27	170	33	6	18.3	16	S223 - 3	2504-M5x12	
AIKT-HS223-R/L-25-3-T6	●	○	25	32	200	40	6	23	18.5		2504-M5x16	

HRN Ucuna Uygundur. / Compatible with HRN Insert. / Kompatibel mit HRN Wendeplatten.

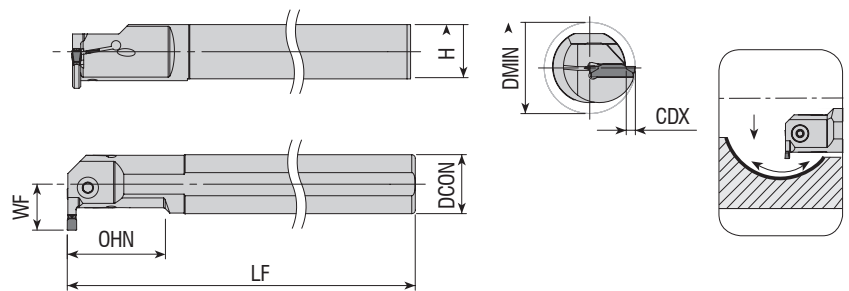

Takım Kodu Ordering Code Bestell-Bezeichnung	Stok Stock Lager		Takım Ölçüleri (mm) Dimension (mm) Abmessung (mm)						Kesici Uç Insert Wendeschneidplatte	Yedek Parçaları / Spare Parts / Ersatzteile		
	R	L	DCON	DMIN	LF	OHN	CDX	H		WF	Sıkma Vidası Screw Klemmschraube	Anahtar Allen Key Innensechskantschlüssel
AIKT-KM-R/L-20-2-T7	●	●	20	25	170	40	7	18.3	13	A4. - 2	2503-M4x12	AAL-03-3
AIKT-KM-R/L-20-3-T7	●	○	20	25	170	40	7	18.3	13		2504-M5x12	AAL-05-4
AIKT-KM-R/L-25-3-T10	●	●	25	32	200	50	10	23	17	A4. - 3	2505-M6x16	AAL-07-5
AIKT-KM-R/L-32-3-T12	●	●	32	40	250	64	12	30	22		2505-M6x20	AAL-05-4
AIKT-KM-R/L-40-3-T12	●	●	40	48	300	80	12	37.5	27	A4. - 4	2504-M5x12	
AIKT-KM-R/L-20-4-T7	●	○	20	25	170	40	7	18.3	13		2504-M5x14	
AIKT-KM-R/L-32-4-T12.2-H	●	○	32	40	190	104	12.2	31	22			

R: Sağ / Right / Rechts L: Sol / Left / Links

● Stokta / In Stock / Auf Lager ○ Stokta Yok / Non Stock Item / Kein Lagerartikel, Lieferzeit auf Anfrage  
KNMTL Ucuna Uygundur. / Compatible with KNMTL Insert. / Kompatibel mit KNMTL Wendeplatten.

Sipariş Örneği/Ordering Example/Bestellbeispiel

1 ad./pcs./stück AIKT-HK-R-20-2-T6

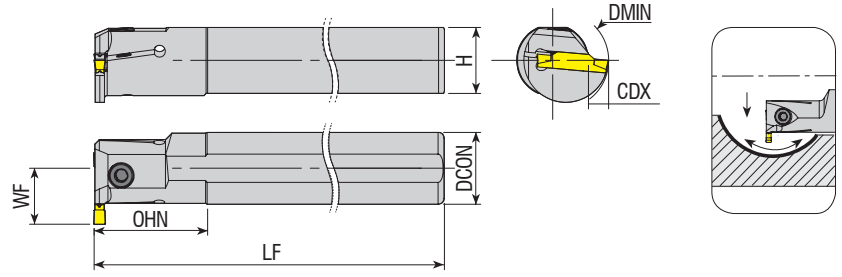

Takım Kodu Ordering Code Bestell-Bezeichnung	Stok Stock Lager		Takım Ölçüleri (mm) Dimension (mm) Abmessung (mm)							Kesici Uç Insert Wendeschneidplatte	Yedek Parçaları / Spare Parts / Ersatzteile	
	R	L	DCON	DMIN	LF	OHN	CDX	H	WF		Sıkma Vidası Screw Klemmschraube	Anahtar Allen Key Innensechskantschlüssel
AIKT-123-R/L-20-2-T6	●	○	20	32	170	30	6	18.3	16	123 - 2	2503-M4x12	AAL-03-3
AIKT-123-R/L-25-2-T6	●	○	25	32	200	40	6	18.3	18.5		2504-M5x12	
AIKT-123-R/L-32-2-T7	●	○	32	41	250	45	7	30	23		2004-M8x1x20	
AIKT-123-R/L-20-3-T6	●	○	20	32	170	30	6	18.3	16	123 - 3	2504-M5x16	AAL-05-4
AIKT-123-R/L-25-3-T7	●	○	25	32	200	40	7	23	19.5		2004-M8x1x20	
AIKT-123-R/L-32-3-T9	●	○	32	41	250	50	9	30	25		2504-M5x16	
AIKT-123-R/L-20-4-T8	●	○	20	29	170	30	8	18.3	18	123 - 4	2004-M8x1x20	
AIKT-123-R/L-25-4-T7	●	○	25	32	200	40	7	23	19.5		2504-M5x16	
AIKT-123-R/L-32-4-T7	●	○	32	41	250	45	7	30	23		2004-M8x1x20	
AIKT-123-R/L-32-4-T10	●	○	32	43	250	50	10	30	26	123 - 5	2504-M5x16	
AIKT-123-R/L-25-5-T8	●	○	25	34	200	40	8	23	20.5		2004-M8x1x20	
AIKT-123-R/L-32-5-T11	●	○	32	43	250	50	11	30	27		2504-M5x16	

SNDVK Ucuna Uygundur. / Compatible with SNDVK Insert. / Kompatibel mit SNDVK Wendeplatten.

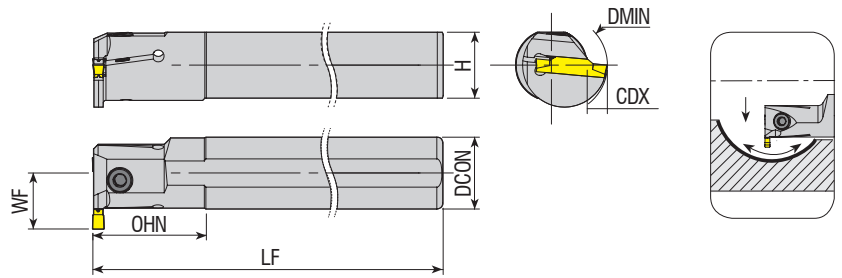

Takım Kodu Ordering Code Bestell-Bezeichnung	Stok Stock Lager		Takım Ölçüleri (mm) Dimension (mm) Abmessung (mm)							Kesici Uç Insert Wendeschneidplatte	Yedek Parçaları / Spare Parts / Ersatzteile	
	R	L	DCON	DMIN	LF	OHN	CDX	H	WF		Sıkma Vidası Screw Klemmschraube	Anahtar Allen Key Innensechskantschlüssel
AIKT-151.23-R/L-20-2-T6	●	○	20	32	170	30	6	18.3	16	151.23 - 2	2503-M4x12	AAL-03-3
AIKT-151.23-R/L-20-2.5-T6	●	○	20	32	170	30	6	18.3	16	151.23 - 2.5		
AIKT-151.22-R/L-25-3-T6	○	●	25	37	200	32	6	23	18.5	151.23 - 3		
AIKT-151.22-R/L-25-3-T6-H	○	●	25	37	200	32	6	23	18.5			

R: Sağ / Right / Rechts L: Sol / Left / Links

● Stokta / In Stock / Auf Lager ○ Stokta Yok / Non Stock Item / Kein Lagerartikel, Lieferzeit auf Anfrage  
SNDVK Ucuna Uygundur. / Compatible with SNDVK Insert. / Kompatibel mit SNDVK Wendeplatten.

Sipariş Örneği/Ordering Example/Bestellbeispiel  
1 ad./pcs./stück AIKT-123-R-20-2-T6



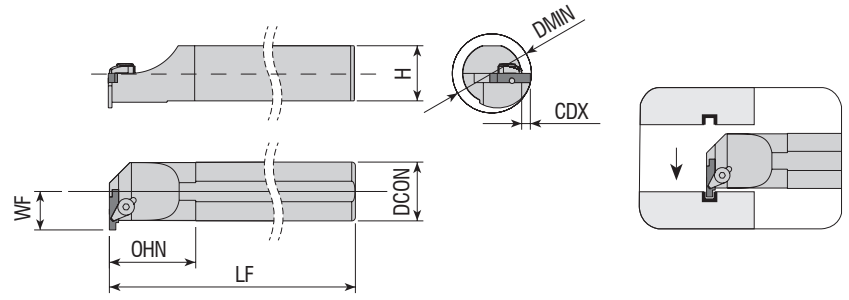

Takım Kodu Ordering Code Bestell-Bezeichnung	Stok Stock Lager		Takım Ölçüleri (mm) Dimension (mm) Abmessung (mm)							Kesici Uç Insert Wendeschneidplatte	Yedek Parçaları / Spare Parts / Ersatzteile				
	R	L	DCON	DMIN	LF	OHN	CDX	H	WF		Baskı Parçası Wedge Clamp Spannpratze	Sıkma Vidası Screw Klemmschraube	Pim Pin Stift	Anahtar Allen Key Innensechskantschlüssel	
AIKT-154.91-R/L-16-3-T3	●	●	16	20	150	35	3	14.8	11	154.91 - 3	ACK-06	AKV-10-M6x14	APM-06	AAL-05-4	
AIKT-154.91-R/L-20-3-T4	●	●	20	25	170	38	4	18.3	14						
AIKT-154.91-R/L-25-3-T4	●	●	25	31	200	40	4	23	16.5						
AIKT-154.91-R/L-25-5-T5	●	●	25	31	200	45	5	23	17.5	154.91 - 5	ACK-03	AKV-21-M6x18			AAL-03-3
AIKT-154.91-R/L-32-5-T5	●	●	32	38	250	50	5	30	21						

SNDVK Ucuna Uygundur. / Compatible with SNDVK Insert. / Kompatibel mit SNDVK Wendeplatten.

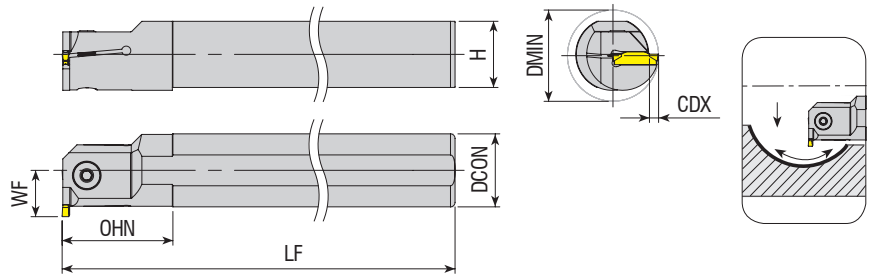

Takım Kodu Ordering Code Bestell-Bezeichnung	Stok Stock Lager		Takım Ölçüleri (mm) Dimension (mm) Abmessung (mm)							Kesici Uç Insert Wendeschneidplatte	Yedek Parçaları / Spare Parts / Ersatzteile		
	R	L	DCON	DMIN	LF	OHN	CDX	H	WF		Sıkma Vidası Screw Klemmschraube	Anahtar Allen Key Innensechskantschlüssel	
AIKT-RD-R/L-16-2-T6	●	○	16	24	150	28	6	14.8	14	RD. - 2	2503-M4x10	AAL-03-3	
AIKT-RD-R/L-20-2-T6	●	○	20	28	170	28	6	18.3	16				
AIKT-RD-R/L-25-2-T6	●	○	25	33	200	28	6	23	18.5				
AIKT-RD-R/L-16-3-T6	●	○	16	24	150	28	6	14.8	14	RD. - 3	2503-M4x10		AAL-05-4
AIKT-RD-R/L-20-3-T6	●	○	20	28	170	28	6	18.3	16				
AIKT-RD-R/L-25-3-T6	●	○	25	33	200	28	6	23	18.5				
AIKT-RD-R/L-32-3-T6	●	○	32	40	250	50	6	30	22	RD. - 4	2004-M8x1x20		
AIKT-RD-R/L-20-4-T6	●	○	20	28	170	28	6	18.3	16			2504-M5x12	
AIKT-RD-R/L-25-4-T6	●	○	25	33	200	28	6	23	18.5	2504-M5x16			
AIKT-RD-R/L-32-4-T6	●	○	32	40	250	50	6	30	22		2004-M8x1x20		

R: Sağ / Right / Rechts L: Sol / Left / Links  
● Stokta / In Stock / Auf Lager ○ Stokta Yok / Non Stock Item / Kein Lagerartikel, Lieferzeit auf Anfrage  
TGTC Ucuna Uygundur. / Compatible with TGTC Insert. / Kompatibel mit TGTC Wendeplatten.

Sipariş Örneği/Ordering Example/Bestellbeispiel  
1 ad./pcs./stück AIKT-154.91-R-16-3-T3

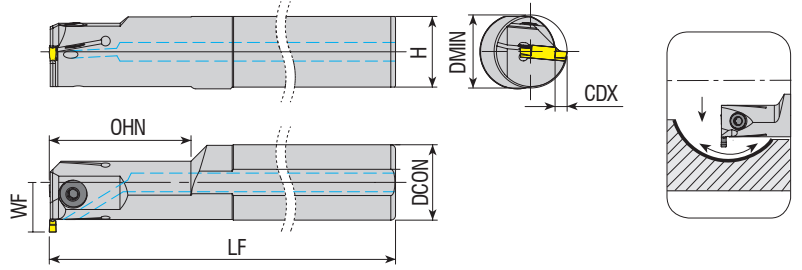

Takım Kodu Ordering Code Bestell-Bezeichnung	Stok Stock Lager		Takım Ölçüleri (mm) Dimension (mm) Abmessung (mm)							Kesici Uç Insert Wendeschneidplatte	Yedek Parçaları / Spare Parts / Ersatzteile	
	R	L	DCON	DMIN	LF	OHN	CDX	H	WF		Sıkma Vidası Screw Klemmschraube	Anahtar Allen Key Innensechskantschlüssel
AIKT-TD-R/L-16-2-T8.5-H	●	○	16	25	150	28	8.5	14.8	16.5	TD. - 2	2503-M4x10	AAL-03-3
AIKT-TD-R/L-20-3-T6-H	●	○	20	25	170	40	6	18.3	16			
AIKT-TD-R/L-25-3-T6-H	●	○	25	25	200	40	6	23	18.5	TD. - 3	2504-M5x12 2504-M5x16	AAL-05-4
AIKT-TD-R/L-32-3-T5-H	●	○	32	31	250	60	5	30	21			
<b>new</b> AIKT-TD-R/L-20-4-T10-H	○	●	20	27	170	40	10	18.3	20	TD. - 4	2504-M5X12 2504-M5X16	AAL-05-4
<b>new</b> AIKT-TD-R/L-25-4-T10-H	○	●	25	31	200	40	10	23	22.5			
<b>new</b> AIKT-TD-R/L-32-4-T10-H	○	●	32	36	250	60	10	30	26		2004-M8X1X20	

TGTC Ucuna Uygun. / Compatible with TGTC Insert. / Kompatibel mit TGTC Wendepplatten.

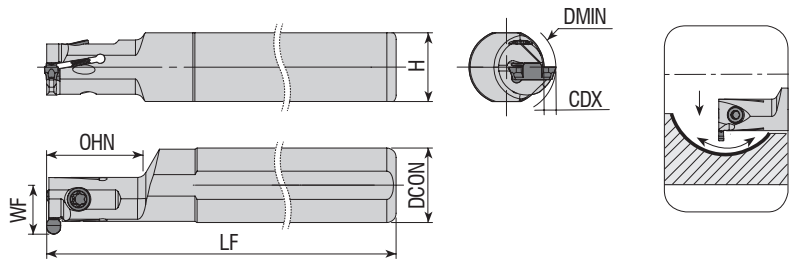

Takım Kodu Ordering Code Bestell-Bezeichnung	Stok Stock Lager		Takım Ölçüleri (mm) Dimension (mm) Abmessung (mm)							Kesici Uç Insert Wendeschneidplatte	Yedek Parçaları / Spare Parts / Ersatzteile	
	R	L	DCON	DMIN	LF	OHN	CDX	H	WF		Sıkma Vidası Screw Klemmschraube	Tork Anahtar Torx Key Torx Innensechskantschlüssel
AIKT-IGE-R/L-10-2-T3-H	●	○	10	11.5	125	25	3	9	8.3	GEPI - 2	3008-M3x8	82-T08
AIKT-IGE-R/L-16-2-T3-D11.5	●	○	16	11.5	125	20	3	14.8	11.1			
<b>new</b> AIKT-IGE-R/L-16-2-T3-D11.5-H	●	○	16	11	125	22	3	14.8	11	GEPI - 3	1315-M4x11	80-T15
AIKT-IGE-R/L-16-2-T2.5-H	●	●	16	13	125	20	2.5	14.8	10.5			
AIKT-IGE-R/L-16-3-T2.5-H	●	○	16	13	125	20	2.5	14.8	10.5			
AIKT-IGE-R/L-16-3-T2.5-D20	●	○	16	20	125	28	2.5	14.8	10.5			

R: Sağ / Right / Rechts L: Sol / Left / Links

● Stokta / In Stock / Auf Lager ○ Stokta Yok / Non Stock Item / Kein Lagerartikel, Lieferzeit auf Anfrage  
ISCR Ucuna Uygun. / Compatible with ISCR Insert. / Kompatibel mit ISCR Wendepplatten.

Sipariş Örneği/Ordering Example/Bestellbeispiel  
1 ad./pcs./stück AIKT-TD-R-16-2-T8.5-H

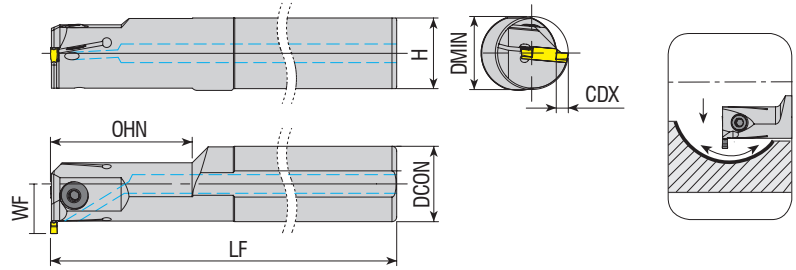

Takım Kodu Ordering Code Bestell-Bezeichnung	Stok Stock Lager		Takım Ölçüleri (mm) Dimension (mm) Abmessung (mm)							Kesici Uç Insert Wendeschneidplatte	Yedek Parçaları / Spare Parts / Ersatzteile		
	R	L	DCON	DMIN	LF	OHN	CDX	H	WF		Sıkma Vidası Screw Klemmschraube	Tork Anahtar Torx Key Innensechskantschlüssel	Anahtar Allen Key Innensechskantschlüssel
AIKT-IGI-R/L-20-3-T4	●	●	20	20	170	25	4	18.3	14.5	GIMIY / GIPI - 3	1020-M5x14	80-T20	
AIKT-IGI-R/L-25-3-T5	●	●	25	23	200	30	5	23	17		2504-M5x16	AAL-05-4	
AIKT-IGI-R/L-32-3-T5	●	●	32	31	250	30	5	30	21		2004-M8x1x20		
AIKT-IGI-R/L-40-3-T5	●	○	40	50	300	50	5	37.5	25	GIMIY / GIPI - 4	1020-M5x14	80-T20	
AIKT-IGI-R/L-20-4-T4	●	●	20	20	170	25	4	18.3	14.5				
AIKT-IGI-R/L-25-5-T10	●	○	25	32	200	25	10	23	22.5	GIMIY / GIPI - 5	2504-M5x16	AAL-05-4	
AIKT-IGI-R/L-25-5-T10-H	●	○	25	32	200	25	10	23	22.5				
AIKT-IGI-R/L-25-5-T15	●	○	25	37	200	25	15	23	27.5				
AIKT-IGI-R/L-25-5-T15-H	●	○	25	37	200	25	15	23	27.5				

ISCR Ucuna Uygun. / Compatible with ISCR Insert. / Kompatibel mit ISCR Wendeplatten.

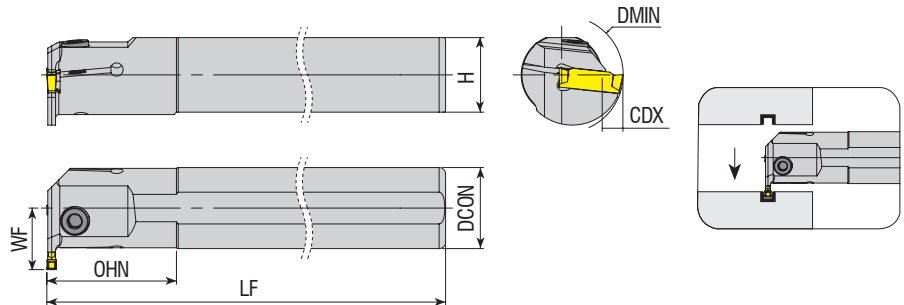

Takım Kodu Ordering Code Bestell-Bezeichnung	Stok Stock Lager		Takım Ölçüleri (mm) Dimension (mm) Abmessung (mm)							Kesici Uç Insert Wendeschneidplatte	Yedek Parçaları / Spare Parts / Ersatzteile		
	R	L	DCON	DMIN	LF	OHN	CDX	H	WF		Sıkma Vidası Screw Klemmschraube	Tork Anahtar Torx Key Innensechskantschlüssel	Anahtar Allen Key Innensechskantschlüssel
AIKT-I-R/L-20-3-T5	●	●	20	26	170	25	5	18.3	15.5	DGN - 3	2504-M5x12	AAL-05-4	
AIKT-I-R/L-25-3-T6	●	●	25	32	200	40	6	23	19		2504-M5x16		

R: Sağ / Right / Rechts L: Sol / Left / Links

● Stokta / In Stock / Auf Lager ○ Stokta Yok / Non Stock Item / Kein Lagerartikel, Lieferzeit auf Anfrage

ISCR Ucuna Uygun. / Compatible with ISCR Insert. / Kompatibel mit ISCR Wendeplatten.

Sipariş Örneği/Ordering Example/Bestellbeispiel

1 ad./pcs./stück AIKT-IGI-R-20-3-T4

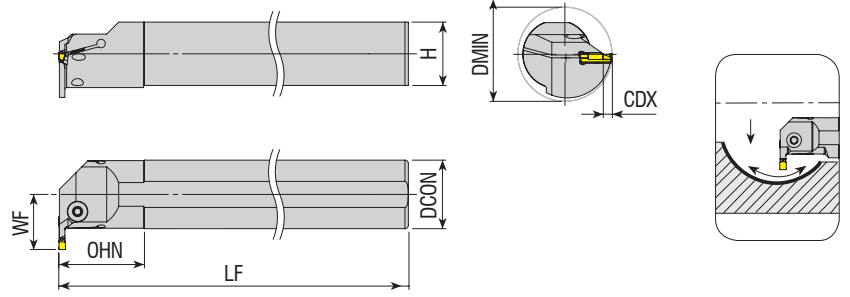

Takım Kodu Ordering Code Bestell-Bezeichnung	Stok Stock Lager		Takım Ölçüleri (mm) Dimension (mm) Abmessung (mm)							Kesici Uç Insert Wendeschneidplatte	Yedek Parçaları / Spare Parts / Ersatzteile	
	R	L	DCON	DMIN	LF	OHN	CDX	H	WF		Sıkma Vidası Screw Klemmschraube	Anahtar Allen Key Innensechskantschlüssel
AIKT-IG-R/L-25-4-T10-H	●	●	25	36	200	40	10	23	22.7	DGN / GRP - 4	2504-M5X16	AAL-05-4
AIKT-IG-R/L-32-4-T10-H	●	●	32	43	250	45	10	30	26.2		2004-M8x1x20	
AIKT-IG-R/L-40-4-T12-H	●	●	40	53	250	50	12	37.5	32.2		2504-M5X16	
AIKT-IG-R/L-25-5-T10-H	●	○	25	43	200	40	10	23	22.7	DGN / GRP - 5	2004-M8x1x20	
AIKT-IG-R/L-32-5-T10-H	●	○	32	43	250	45	10	30	26.2		2504-M5X16	
AIKT-IG-R/L-40-5-T12-H	●	○	40	53	250	50	12	37.5	32.2		2004-M8x1x20	
AIKT-IG-R/L-50-5-T12-H	●	○	50	63	300	60	12	47	37.2		2004-M8x1x20	

ISCR Ucuna Uygun / Compatible with ISCR Insert / Kompatibel mit ISCR Wendepalten.

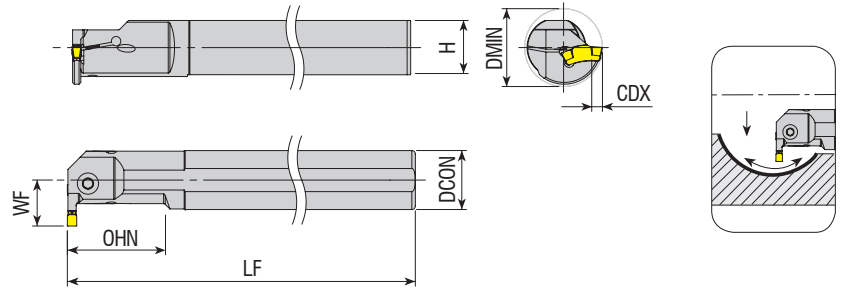

Takım Kodu Ordering Code Bestell-Bezeichnung	Stok Stock Lager		Takım Ölçüleri (mm) Dimension (mm) Abmessung (mm)							Kesici Uç Insert Wendeschneidplatte	Yedek Parçaları / Spare Parts / Ersatzteile	
	R	L	DCON	DMIN	LF	OHN	CDX	H	WF		Sıkma Vidası Screw Klemmschraube	Tork Anahtar Torx Key Torx Innensechskantschlüssel
AIKT-ITG-R/L-16-3-T6-H	●	●	16	20	150	25	6	14.8	12	TGM. - 3	1020-M4.5X14	80-T20
AIKT-ITG-R/L-20-3-T6-H	●	●	20	25	170	32	6	18.3	14.2		1020-M4.5X16	
AIKT-ITG-R/L-25-3-T8-H	●	●	25	32	200	40	8	23	18.8		2504-M5X16	AAL-05-4
AIKT-ITG-R/L-32-3-T8-H	●	●	32	38	250	49	8	30	22		2004-M8x1x20	
AIKT-ITG-R/L-20-4-T6-H	●	●	20	25	170	33	6	18.3	14.2	TGM. - 4	1020-M4.5X16	80-T20
AIKT-ITG-R/L-25-4-T7-H	●	●	25	31	200	41	7	23	17.5		2504-M5X16	
AIKT-ITG-R/L-25-4-T9-H	●	●	25	32.5	200	41	9	23	19.5		2004-M8x1x20	AAL-05-4
AIKT-ITG-R/L-32-4-T11-H	●	●	32	42	250	50	11	30	25.5			
AIKT-ITG-R/L-40-4-T11-H	●	●	40	53	300	50	11	37.5	32	TGM. - 6.35	2004-M8x1x20	
AIKT-ITG-R/L-32-6.35-T17.5-H	●	●	32	57	250	50	17.5	30	29			

R: Sağ / Right / Rechts L: Sol / Left / Links

● Stokta / In Stock / Auf Lager ○ Stokta Yok / Non Stock Item / Kein Lagerartikel, Lieferzeit auf Anfrage  
ISCR Ucuna Uygun / Compatible with ISCR Insert / Kompatibel mit ISCR Wendepalten.

Sipariş Örneği/Ordering Example/Bestellbeispiel  
1 ad./pcs./stück AIKT-IG-R-25-4-T10-H

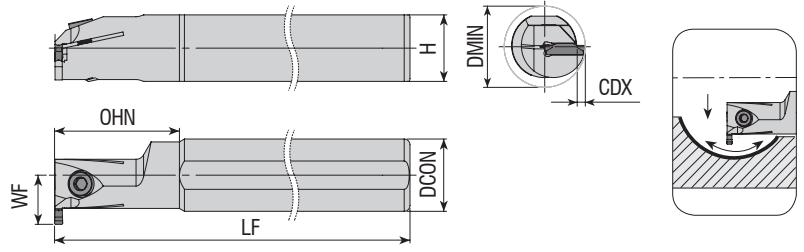

Takım Kodu Ordering Code Bestell-Bezeichnung	Stok Stock Lager		Takım Ölçüleri (mm) Dimension (mm) Abmessung (mm)							Kesici Uç Insert Wendescheidplatte	Yedek Parçaları / Spare Parts / Ersatzteile	
	R	L	DCON	DMIN	LF	OHN	CDX	H	WF		Sıkma Vidası Screw Klemmschraube	Anahtar Allen Key Innensechskantschlüssel
AIKT-GP-R/L-20-2-T4	●	○	20	25	170	30	4	18.3	14.5	GP - 2	2503-M4x12	AAL-03-3
AIKT-GP-R/L-25-2-T6	●	○	25	32	200	40	6	23	18.5			
AIKT-GP-R/L-20-3-T6	●	○	20	27	170	30	6	18.3	16	GP - 3	2504-M5x16	AAL-05-4
AIKT-GP-R/L-25-3-T6	●	○	25	32	200	40	6	23	18.5			
AIKT-GP-R/L-32-3-T6	●	○	32	39	250	50	6	30	22			
AIKT-GP-R/L-20-4-T6	●	○	20	27	170	30	6	18.3	16	GP - 4	2504-M5x16	
AIKT-GP-R/L-25-4-T6	●	○	25	32	200	40	6	23	18.5		2004-M8x1x20	
AIKT-GP-R/L-32-4-T6	●	○	32	39	250	50	6	30	22		2004-M8x1x20	

PLBT Ucuna Uygunudur. / Compatible with PLBT Insert. / Kompatibel mit PLBT Wendeplatten.

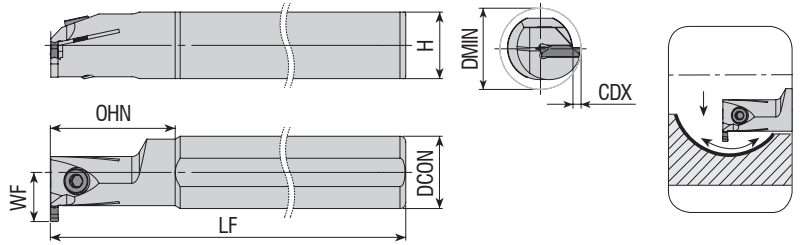

Takım Kodu Ordering Code Bestell-Bezeichnung	Stok Stock Lager		Takım Ölçüleri (mm) Dimension (mm) Abmessung (mm)							Kesici Uç Insert Wendescheidplatte	Yedek Parçaları / Spare Parts / Ersatzteile	
	R	L	DCON	DMIN	LF	OHN	CDX	H	WF		Sıkma Vidası Screw Klemmschraube	Tork Anahtar Torx Key Torx Innensechskantschlüssel
AIKT-TG-R/L-20-2-T6	●	○	20	28	160	28	6	18.3	15.8	DGM2-020	2503-M4x10	AAL-03-3
AIKT-TG-R/L-20-3-T6	●	○	20	28	160	28	6	18.3	15.8	DTX3-030	2504-M5x12	
AIKT-TG-R/L-25-3-T8	●	○	25	35	200	28	8	23	21.5		DTX4-040	2504-M5x16
AIKT-TG-R/L-32-3-T10	●	○	32	43	250	50	10	30	27			
AIKT-TG-R/L-32-3-T12	●	○	32	45	250	50	12	30	27			
AIKT-TG-R/L-32-4-T10	●	○	32	43	250	50	10	30	27	DTX5-040	2004-M8x1x20	
AIKT-TG-R/L-32-5-T10	●	○	32	43	250	50	10	30	27			

R: Sağ / Right / Rechts L: Sol / Left / Links  
● Stokta / In Stock / Auf Lager ○ Stokta Yok / Non Stock Item / Kein Lagerartikel, Lieferzeit auf Anfrage  
TNGLY Ucuna Uygunudur. / Compatible with TNGLY Insert. / Kompatibel mit TNGLY Wendeplatten.

Sipariş Örneği/Ordering Example/Bestellbeispiel  
1 ad./pcs./stück AIKT-GP-R-20-2-T4

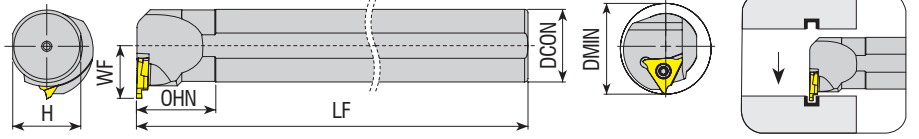

Takım Kodu Ordering Code Bestell-Bezeichnung	Stok Stock Lager		Takım Ölçüleri (mm) Dimension (mm) Abmessung (mm)							Kesici Uç Insert Wendeschneidplatte	Yedek Parçaları / Spare Parts / Ersatzteile	
	R	L	DCON	DMIN	LF	OHN	CDX	H	WF		Sıkma Vidası Screw Klemmschraube	Tork Anahtar Torx Key Torx Innensechskantschlüssel
AIKT-QC11-R/L-20-(0.5-1.8)	●	○	20	16	150	40	-	18.3	11.1		3008 M2.5x6	82-T08
AIKT-QC16-R/L-20-(0.5-1.8)	○	○	20	25	150	35	-	18.3	13.5			
AIKT-QC16-R/L-20-(0.5-2.5)	●	○	20	25	150	35	-	18.3	13.5	1020 M5x11	80-T20	
AIKT-QC22-R/L-25-(1-2.3)	○	○	25	35	150	35	-	23	18.2			QC22R/L (1.00-2.30)
AIKT-QC22-R/L-25-(2.5-3.3)	●	○	25	35	150	35	-	23	18.2	QC22R/L (2.50-3.30)	80-T20	
AIKT-QC22-R/L-25-(3.3-4.8)	●	○	25	35	150	35	-	23	18.2			QC22R/L (3.30-4.80)
AIKT-QC22-R/L-32-(1-2.3)	○	○	32	45	150	35	-	30	23.2	QC22R/L (1.00-2.30)		

ZCC Ucuna Uygundur. / Compatible with ZCC Insert. / Kompatibel mit ZCC Wendeplatten.

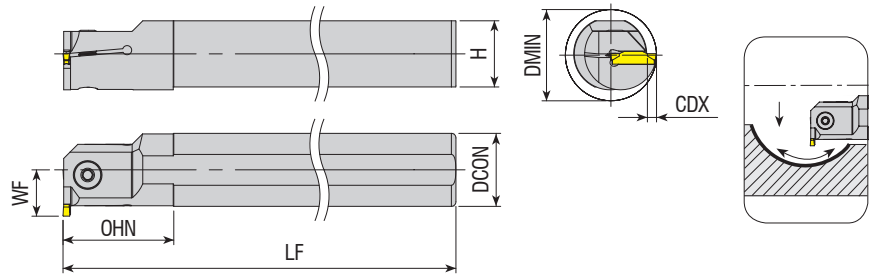

Takım Kodu Ordering Code Bestell-Bezeichnung	Stok Stock Lager		Takım Ölçüleri (mm) Dimension (mm) Abmessung (mm)							Kesici Uç Insert Wendeschneidplatte	Yedek Parçaları / Spare Parts / Ersatzteile	
	R	L	DCON	DMIN	LF	OHN	CDX	H	WF		Sıkma Vidası Screw Klemmschraube	Anahtar Allen Key Innensechskantschlüssel
AIKT-ZCC2-R/L-16-2-T4	●	○	16	21	150	28	4	14.8	12	Z.BD - 2	2503-M4x10	AAL-03-3
AIKT-ZCC2-R/L-20-3-T5	●	●	20	27	170	30	5	18.3	15			
AIKT-ZCC2-R/L-20-3-T8	●	○	20	29	170	30	8	18.3	18	2504-M5x16	AAL-05-4	
AIKT-ZCC2-R/L-25-3-T5	●	○	25	31	200	40	5	23	17.5			2004-M8x1x20
AIKT-ZCC2-R/L-25-3-T10	●	○	25	36	200	40	10	23	22.5	Z.GD - 4	AAL-05-4	
AIKT-ZCC2-R/L-32-3-T6	●	○	32	39	250	50	6	30	22			2504-M5x12
AIKT-ZCC2-R/L-32-3-T8	●	○	32	41	250	50	8	30	24	2504-M5x16	AAL-05-4	
AIKT-ZCC2-R/L-32-3-T13	●	○	32	46	250	50	13	30	29			2004-M8x1x20
AIKT-ZCC2-R/L-40-3-T12	●	○	40	53	300	55	12	37.5	32	Z.HD - 5	AAL-05-4	
AIKT-ZCC2-R/L-25-4-T6	●	○	25	32	200	40	6	23	18.5			2504-M5x16
AIKT-ZCC2-R/L-32-4-T7	●	○	32	40	250	50	7	30	23	2004-M8x1x20	AAL-05-4	
AIKT-ZCC2-R/L-32-4-T8	●	○	32	41	250	50	8	30	24			Z.HD - 5
AIKT-ZCC2-R/L-32-4-T10	●	○	32	43	250	50	10	30	26	2504-M5x12	AAL-05-4	
AIKT-ZCC2-R/L-32-5-T7	●	○	32	40	250	50	7	30	23			2004-M8x1x20
AIKT-ZCC2-R/L-32-5-T8	●	○	32	41	250	50	8	30	24	Z.HD - 5	AAL-05-4	
AIKT-ZCC2-R/L-40-5-T8	●	○	40	49	300	55	8	37.5	28			2504-M5x12
AIKT-ZCC2-R/L-40-5-T10	●	○	40	51	300	55	10	37.5	30	2004-M8x1x20	AAL-05-4	

R: Sağ / Right / Rechts L: Sol / Left / Links

● Stokta / In Stock / Auf Lager ○ Stokta Yok / Non Stock Item / Kein Lagerartikel, Lieferzeit auf Anfrage

ZCC Ucuna Uygundur. / Compatible with ZCC Insert. / Kompatibel mit ZCC Wendeplatten.

Sipariş Örneği/Ordering Example/Bestellbeispiel

1 ad./pcs./stück AIKT-QC11-R-20-(0.5-1.8)

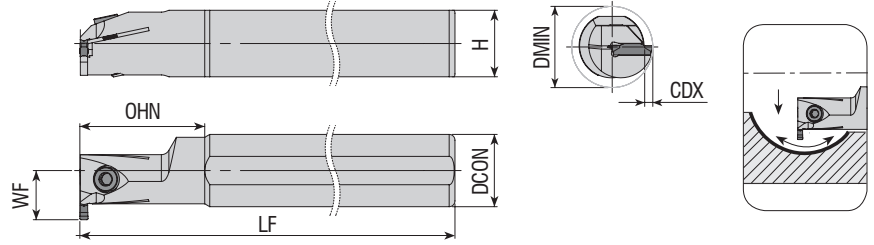

Takım Kodu Ordering Code Bestell-Bezeichnung	Stok Stock Lager		Takım Ölçüleri (mm) Dimension (mm) Abmessung (mm)							Kesici Uç Insert Wendeschneidplatte	Yedek Parçaları / Spare Parts / Ersatzteile	
	R	L	DCON	DMIN	LF	OHN	CDX	H	WF		Sıkma Vidası Screw Klemmschraube	Anahtar Allen Key Innensechskantschlüssel
AIKT-SGC-R/L-25-3-T6	●	○	25	32	200	40	6	23	18.5	GCM N30	2504-M5x16	AAL-05-4
AIKT-SGC-R/L-32-3-T6	●	○	32	39	250	50	6	30	22		2004-M8x1x20	
AIKT-SGC-R/L-40-3-T6	●	○	40	47	300	55	6	37.5	26			

SMTM Ucuna Uygunur. / Compatible with SMTM Insert. / Kompatibel mit SMTM Wendeplatten.

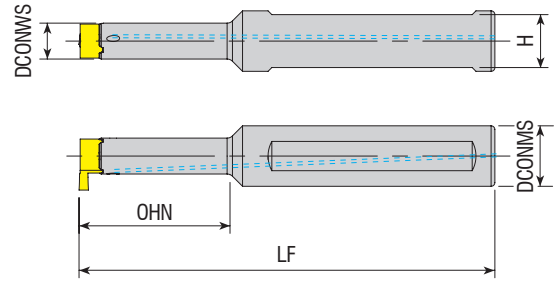

Takım Kodu Ordering Code Bestell-Bezeichnung	Stok Stock Lager	Takım Ölçüleri (mm) Dimension (mm) Abmessung (mm)					Kesici Uç Insert Wendeschneidplatte	Yedek Parçaları / Spare Parts / Ersatzteile	
		DCONMS	DCONWS	LF	OHN	H		Sıkma Vidası Screw Klemmschraube	Tork Anahtar Torx Key Torx Innensechskantschlüssel
AIKT-MB07-A16-090-15	●	16	7.4	90	15	14	MB - 07	4008-M3x8	82-T08
AIKT-MB07-A16-090-22	●	16	7.4	90	22	14			
AIKT-MB09-A16-090-19	●	16	9.5	90	19	14	MB - 09	4015-M4x11	80-T15
AIKT-MB09-A16-095-28	●	16	9.5	95	28	14			
AIKT-MB09-A16-110-40	●	16	9.5	110	40	14			

R: Sağ / Right / Rechts L: Sol / Left / Links

● Stokta / In Stock / Auf Lager ○ Stokta Yok / Non Stock Item / Kein Lagerartikel, Lieferzeit auf Anfrage

SNDVK Ucuna Uygunur. / Compatible with SNDVK Insert. / Kompatibel mit SNDVK Wendeplatten.

Sipariş Örneği/Ordering Example/Bestellbeispiel  
1 ad./pcs./stück AIKT-SGC-R-25-3-T6

**konusulan**  
**the spoken kalite...**  
**quality...**







**DELİK DELME ve İŞLEME TAKIMLARI**  
*DRILLING and HOLEMAKING TOOLS*  
*BOHRWERKZEUGE*





*konusulan  
the spoken kalite...  
quality...*

# U-DRILL

TAKMA UÇLU MATKAPLAR  
U-DRILL SYSTEM  
VOLLBOHRER

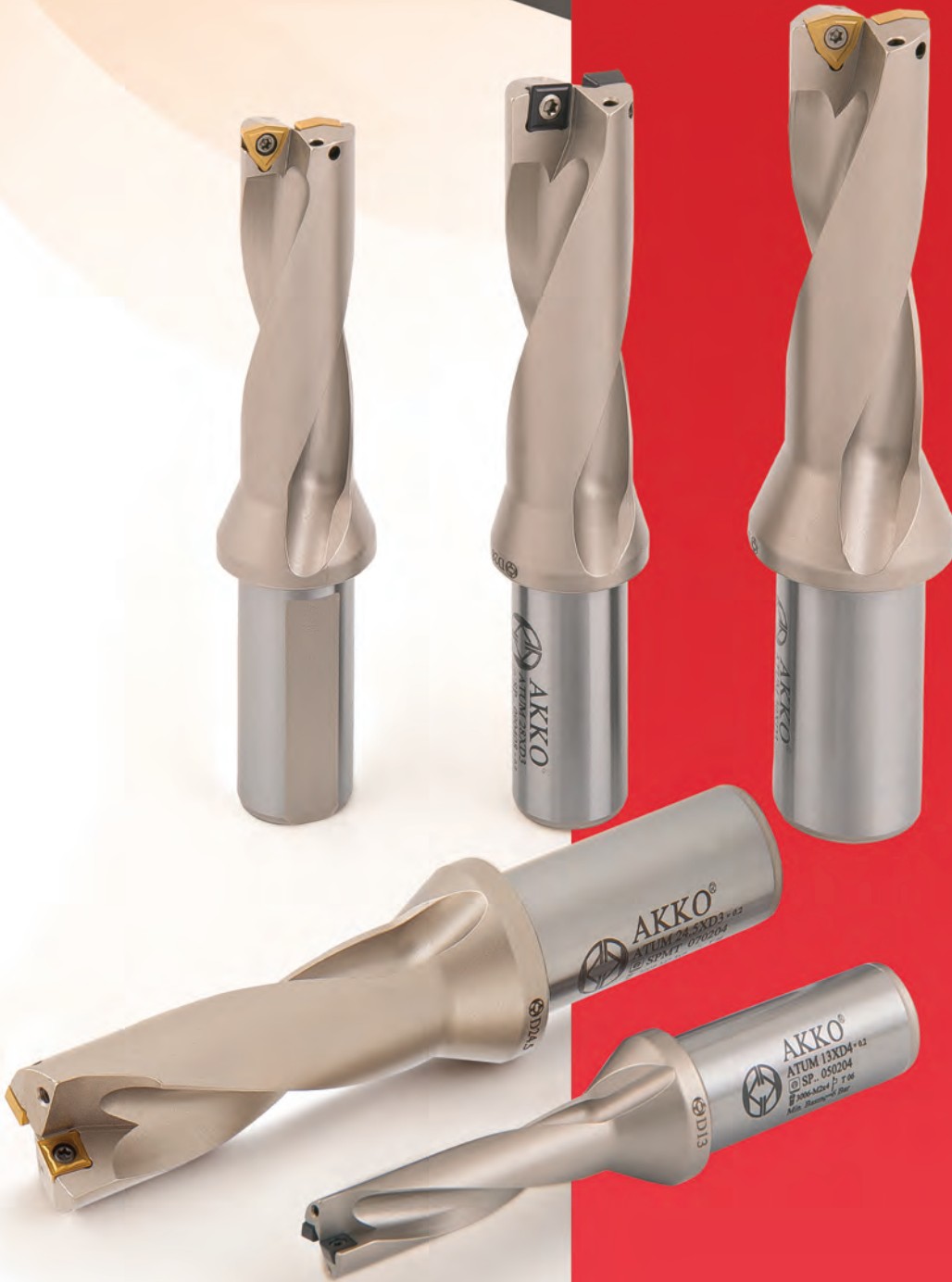



**AKKO** **A** **TUM** **16** x **D3**

**S** **P** **G** **T** **06** **02** **04**

**2** Kesici Stili / Cutter Style  
Werkzeugtyp

TUM: Takma Uçlu Matkap  
U-Drill  
Vollbohrer

**3** Takım Çapı / Tool Diameter /  
Werkzeugdurchmesser

**4** Delme Derinliği / Drilling Depth /  
Bohrtiefe

**5** Uç Şekli / Insert Form  
Plattenform

**W** **S**

**6** Serbest Uç Açısı / Clearance angle of Insert  
Freiwinkel der Wendeschneidplatte

**C** **P**

**8** Uç Tipi / Insert Type  
Plattentyp

**X** Özel  
Special  
Sonder

**10** Kalınlık / Thickness  
Dicke

01 s = 1.59  
T1 s = 1.98  
02 s = 2.38  
T2 s = 2.78  
03 s = 3.18  
T3 s = 3.97  
04 s = 4.76  
05 s = 5.56  
06 s = 6.35  
07 s = 7.94  
09 s = 9.52

**7** Toleranslar / Tolerance Classes / Toleranzen

	IC	M	S
A	± 0.025	± 0.005	± 0.025
C	± 0.025	± 0.013	± 0.025
E	± 0.025	± 0.025	± 0.025
F	± 0.013	± 0.005	± 0.025
G	± 0.025	± 0.025	± 0.130
H	± 0.013	± 0.013	± 0.025
J	± 0.05-0.15	± 0.005	± 0.025
K	± 0.05-0.15	± 0.013	± 0.025
L	± 0.05-0.15	± 0.025	± 0.025
M	± 0.05-0.15	± 0.08-0.20	± 0.130
N	± 0.05-0.15	± 0.08-0.20	± 0.025
U	± 0.08-0.25	± 0.13-0.38	± 0.130

IC : Daire Ölçüsü / Inscribed Circle / Kreisgröße  
M : Şekle Göre / Refer to Figure / Siehe Abbildung  
S : Kalınlık / Thickness / Dicke

**9** Kesme Kenar Uzunluğu / Cutting Edge Length  
Schneidkantenlänge

**11** Köşe Konfigurasyonu / Corner Radius  
Eckenradius

01 r = 0.1  
02 r = 0.2  
04 r = 0.4  
08 r = 0.8  
12 r = 1.2  
16 r = 1.6  
24 r = 2.4



Delme Derinliği  
Drilling Depth  
Bohrtiefe

= 2x Çap  
= 2x Diameter  
= 2x Durchmesser

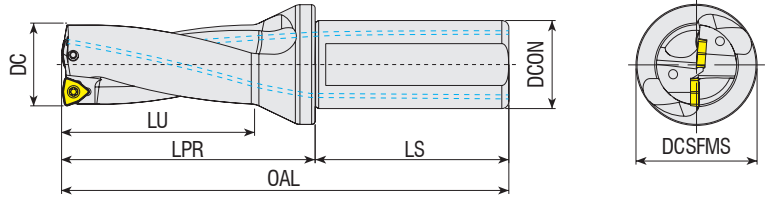

Takım Kodu Ordering Code Bestell-Bezeichnung	Stok Stock Lager	Takım Ölçüleri (mm) Dimension (mm) Abmessung (mm)							Maks. Ofset (radyal) Max. Offset (radial) Max. Versatz (radial)		Kesici Uç Insert Wendeschneidplatte	Yedek Parçaları / Spare Parts / Ersatzteile				
		DC	DCON	DCSFMS	OAL	LU	LPR	LS	X <sub>max</sub>	DC <sub>max</sub>		Sıkma Vidası Screw Schraube	Tork Anahtar Torx Key Torx-Schlüssel			
ATUM 16XD2 WCM. 030208	●	16	25	34	110	32	54	56	1.5	19	WCM. 030208	3008-M2.5x6	82-T08			
ATUM 16.5XD2 WCM. 030208	●	16.5	25	34	110	32	54	56	1.5	19.5						
ATUM 17XD2 WCM. 030208	●	17	25	34	112	34	56	56	1.5	20						
ATUM 17.5XD2 WCM. 030208	●	17.5	25	34	112	34	56	56	1.5	20.5						
ATUM 18XD2 WCM. 030208	●	18	25	34	114	36	58	56	1.4	20.8						
ATUM 18.5XD2 WCM. 030208	●	18.5	25	34	114	36	58	56	1.3	21.1						
ATUM 19XD2 WCM. 030208	●	19	25	34	116	38	60	56	1.2	21.4						
ATUM 19.5XD2 WCM. 030208	●	19.5	25	34	116	38	60	56	1.2	21.9						
ATUM 20XD2 WCM. 040208	●	20	25	34	118	40	62	56	1.5	23				WCM. 040208	3008-M2.5x6	82-T08
ATUM 20.5XD2 WCM. 040208	●	20.5	25	34	118	40	62	56	1.5	23.5						
ATUM 21XD2 WCM. 040208	●	21	25	34	120	42	64	56	1	23						
ATUM 21.5XD2 WCM. 040208	●	21.5	25	34	120	42	64	56	1	23.5						
ATUM 22XD2 WCM. 040208	●	22	25	34	122	44	66	56	1	24						
ATUM 22.5XD2 WCM. 040208	●	22.5	25	34	122	44	66	56	1	24.5						
ATUM 23XD2 WCM. 040208	●	23	25	34	124	46	68	56	1	25						
ATUM 23.5XD2 WCM. 040208	●	23.5	25	34	124	46	68	56	1	25.5						
ATUM 24XD2 WCM. 050308	●	24	25	34	126	48	70	56	1.4	26.8	WCM. 050308	3008-M3x8	82-T08			
ATUM 24.5XD2 WCM. 050308	●	24.5	25	34	126	48	70	56	1.4	27.3						
ATUM 25XD2 WCM. 050308	●	25	25	34	128	50	72	56	1.45	27.9						
ATUM 25.5XD2 WCM. 050308	●	25.5	25	34	128	50	72	56	1.45	28.4						
ATUM 26XD2 WCM. 050308	●	26	25	34	130	52	74	56	1.45	28.9						
ATUM 26.5XD2 WCM. 050308	●	26.5	25	34	130	52	74	56	1.45	29.4						
ATUM 27XD2 WCM. 050308	●	27	25	34	132	54	76	56	1.45	29.9						
ATUM 27.5XD2 WCM. 050308	●	27.5	25	34	132	54	76	56	1.45	30.4						
ATUM 28XD2 WCM. 050308	●	28	25	34	134	56	78	56	1.6	31.2						
ATUM 28.5XD2 WCM. 050308	●	28.5	25	34	134	56	78	56	1.6	31.7						
ATUM 29XD2 WCM. 050308	●	29	25	34	136	58	80	56	1.65	32.3						
ATUM 29.5XD2 WCM. 050308	●	29.5	25	34	136	58	80	56	1.65	32.8						

R: Sağ / Right / Rechts/ L: Sol / Left / Links

● Stokta / In Stock / Auf Lager ○ Stokta Yok / Non Stock Item / Kein Lagerartikel, Lieferzeit auf Anfrage  
ISO Ucuna Uygun. / Compatible with ISO Insert. / Kompatibel mit ISO Wendeplatten.

Sipariş Örneği/Ordering Example/Bestellbeispiel

1 ad./pcs./stück ATUM 16XD2 WCM. 030208

Takma Uçlu Matkap Kullanım Kılavuzu : S 375 / User's Guide For U-Drills : P 375

Bedienungsanleitung für Vollbohrer : S 375



Delme Derinliği  
Drilling Depth  
Bohrtiefe

= 2x Çap  
= 2x Diameter  
= 2x Durchmesser

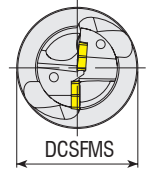
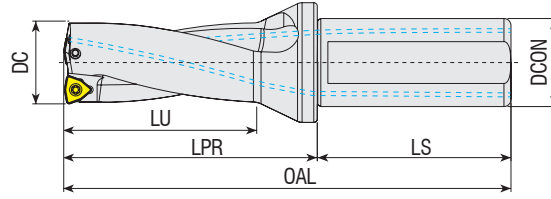

**Takım Kodu**  
**Ordering Code**  
**Bestell-Bezeichnung**

Stok  
Stock  
Lager

Takım Ölçüleri (mm)  
Dimension (mm)  
Abmessung (mm)

Maks. Ofset (radial)  
Max. Offset (radial)  
Max. Versatz (radial)

Kesici Uç  
Insert  
Wendeschneidplatte

Yedek Parçaları / Spare Parts / Ersatzteile

Sıkma Vidası  
Screw  
Schraube

Tork Anahtar  
Torx Key  
Torx-Schlüssel

DC	DCON	DCSFMS	OAL	LU	LPR	LS	X <sub>max</sub> [mm]	DC <sub>max</sub> [mm]
----	------	--------	-----	----	-----	----	-----------------------	------------------------

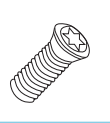

ATUM 30XD2 WCM. 06T308	●	30	32	44	147	60	87	60	2.4	34.8	WCM. 06T308	3010-M3.5x9	82-T10
ATUM 31XD2 WCM. 06T308	●	31	32	44	149	62	89	60	2.3	35.6			
ATUM 32XD2 WCM. 06T308	●	32	32	44	151	64	91	60	2.1	36.2			
ATUM 33XD2 WCM. 06T308	●	33	32	44	153	66	93	60	1.9	36.8			
ATUM 34XD2 WCM. 06T308	●	34	32	44	155	68	95	60	1.9	37.8			
ATUM 35XD2 WCM. 06T308	●	35	32	44	157	70	97	60	1.9	38.8			
ATUM 36XD2 WCM. 06T308	●	36	32	44	159	72	99	60	2	40			
ATUM 37XD2 WCM. 06T308	●	37	32	44	161	74	101	60	1.8	40.6			
ATUM 38XD2 WCM. 06T308	●	38	32	44	163	76	103	60	1.5	41			
ATUM 39XD2 WCM. 06T308	●	39	32	44	165	78	105	60	1.3	41.6			
ATUM 40XD2 WCM. 06T308	●	40	32	44	167	80	107	60	1	42			
ATUM 41XD2 WCM. 06T308	●	41	32	44	169	82	109	60	0.8	42.6			
ATUM 42XD2 WCM. 06T308	●	42	32	44	171	84	111	60	0.5	43			
ATUM 43XD2 WCM. 06T308	●	43	32	44	173	86	113	60	0.3	43.6			
ATUM 44XD2 WCM. 06T308	●	44	32	44	175	88	115	60	0	44			
ATUM 45XD2 WCM. 080412	●	45	40	54	192	90	122	70	3.3	51.6	WCM. 080412	4015-M4x11	80-T15
ATUM 46XD2 WCM. 080412	●	46	40	54	194	92	124	70	3	52			
ATUM 47XD2 WCM. 080412	●	47	40	54	196	94	126	70	2.8	52.6			
ATUM 48XD2 WCM. 080412	●	48	40	54	198	96	128	70	2.5	53			
ATUM 49XD2 WCM. 080412	●	49	40	54	200	98	130	70	2.2	53.4			
ATUM 50XD2 WCM. 080412	●	50	40	54	202	100	132	70	2	54			
ATUM 51XD2 WCM. 080412	●	51	40	54	204	102	134	70	1.8	54.6			
ATUM 52XD2 WCM. 080412	●	52	40	54	206	104	136	70	1.5	55			
ATUM 53XD2 WCM. 080412	●	53	40	54	208	106	138	70	1.3	55.6			
ATUM 54XD2 WCM. 080412	●	54	40	54	210	108	140	70	1	56			
ATUM 55XD2 WCM. 080412	●	55	40	54	212	110	142	70	0.8	56.6			
ATUM 56XD2 WCM. 080412	●	56	40	64	214	112	144	70	0.5	57			
ATUM 57XD2 WCM. 080412	●	57	40	64	216	114	146	70	0.3	57.6			
ATUM 58XD2 WCM. 080412	●	58	40	64	218	116	148	70	0	58			
ATUM 59XD2 WCM. 080412	●	59	40	64	220	118	150	70	0	59			
ATUM 60XD2 WCM. 080412	●	60	40	64	222	120	152	70	0	60			

R: Sağ / Right / Rechts | L: Sol / Left / Links

● Stokta / In Stock / Auf Lager | ○ Stokta Yok / Non Stock Item / Kein Lagerartikel, Lieferzeit auf Anfrage

ISO Ucuna Uygunudur. / Compatible with ISO Insert. / Kompatibel mit ISO Wendeplatten.

Takma Uçlu Matkap Kullanım Kılavuzu : S 375 / User's Guide For U-Drills : P 375 | Bedienungsanleitung für Vollbohrer : S 375

Sipariş Örneği/Ordering Example/Bestellbeispiel

1 ad./pcs./stück ATUM 30XD2 WCM. 06T308



Delme Derinliği  
Drilling Depth  
Bohrtiefe

= 3x Çap  
= 3x Diameter  
= 3x Durchmesser

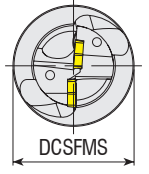
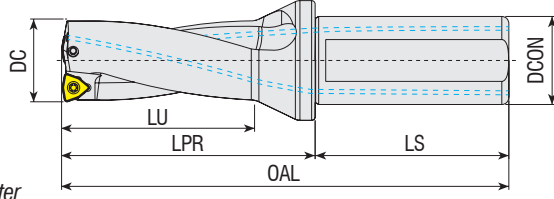

Takım Kodu Ordering Code Bestell-Bezeichnung	Stok Stock Lager	Takım Ölçüleri (mm) Dimension (mm) Abmessung (mm)							Maks. Ofset (radyal) Max. Ofset (radial) Max. Versatz (radial)		Kesici Uç Insert Wendeschneidplatte	Yedek Parçaları / Spare Parts / Ersatzteile	
		DC	DCON	DCSFMS	OAL	LU	LPR	LS	X <sub>max</sub>	DC <sub>max</sub> [mm]		Sıkma Vidası Screw Schraube	Tork Anahtar Torx Key Torx-Schlüssel
ATUM 16XD3 WCM. 030208	●	16	25	34	126	48	70	56	1.5	19	WCM. 030208	3008-M2.5x6	82-T08
ATUM 16.5XD3 WCM. 030208	●	16.5	25	34	126	48	70	56	1.5	19.5			
ATUM 17XD3 WCM. 030208	●	17	25	34	129	51	73	56	1.5	20			
ATUM 17.5XD3 WCM. 030208	●	17.5	25	34	129	51	73	56	1.5	20.5			
ATUM 18XD3 WCM. 030208	●	18	25	34	132	54	76	56	1.4	20.8			
ATUM 18.5XD3 WCM. 030208	●	18.5	25	34	132	54	76	56	1.3	21.1			
ATUM 19XD3 WCM. 030208	●	19	25	34	135	57	79	56	1.2	21.4			
ATUM 19.5XD3 WCM. 030208	●	19.5	25	34	135	57	79	56	1.2	21.9			
ATUM 20XD3 WCM. 040208	●	20	25	34	138	60	82	56	1.5	23	WCM. 040208	3008-M2.5x6	82-T08
ATUM 20.5XD3 WCM. 040208	●	20.5	25	34	138	60	82	56	1.5	23.5			
ATUM 21XD3 WCM. 040208	●	21	25	34	141	63	85	56	1	23			
ATUM 21.5XD3 WCM. 040208	●	21.5	25	34	141	63	85	56	1	23.5			
ATUM 22XD3 WCM. 040208	●	22	25	34	144	66	88	56	1	24			
ATUM 22.5XD3 WCM. 040208	●	22.5	25	34	144	66	88	56	1	24.5			
ATUM 23XD3 WCM. 040208	●	23	25	34	147	69	91	56	1	25			
ATUM 23.5XD3 WCM. 040208	●	23.5	25	34	147	69	91	56	1	25.5			
ATUM 24XD3 WCM. 050308	●	24	25	34	150	72	94	56	1.4	26.8	WCM. 050308	3008-M3x8	82-T10
ATUM 24.5XD3 WCM. 050308	●	24.5	25	34	150	72	94	56	1.4	27.3			
ATUM 25XD3 WCM. 050308	●	25	25	34	153	75	97	56	1.45	27.9			
ATUM 25.5XD3 WCM. 050308	●	25.5	25	34	153	75	97	56	1.45	28.4			
ATUM 26XD3 WCM. 050308	●	26	25	34	156	78	100	56	1.45	28.9			
ATUM 26.5XD3 WCM. 050308	●	26.5	25	34	156	78	100	56	1.45	29.4			
ATUM 27XD3 WCM. 050308	●	27	25	34	159	81	103	56	1.45	29.9			
ATUM 27.5XD3 WCM. 050308	●	27.5	25	34	159	81	103	56	1.45	30.4			
ATUM 28XD3 WCM. 050308	●	28	25	34	162	84	106	56	1.6	31.2			
ATUM 28.5XD3 WCM. 050308	●	28.5	25	34	162	84	106	56	1.6	31.7			
ATUM 29XD3 WCM. 050308	●	29	25	34	165	87	109	56	1.65	32.3			
ATUM 29.5XD3 WCM. 050308	●	29.5	25	34	165	87	109	56	1.65	32.8			
ATUM 30XD3 WCM. 06T308	●	30	32	44	177	90	117	60	2.4	34.8	WCM. 06T308	3010-M3.5x9	82-T10
ATUM 30.5XD3 WCM. 06T308	●	30.5	32	44	177	90	117	60	2.4	35.3			
ATUM 31XD3 WCM. 06T308	●	31	32	44	180	93	120	60	2.3	35.6			
ATUM 31.5XD3 WCM. 06T308	●	31.5	32	44	180	93	120	60	2.3	36.1			
ATUM 32XD3 WCM. 06T308	●	32	32	44	183	96	123	60	2.1	36.2			
ATUM 32.5XD3 WCM. 06T308	●	32.5	32	44	183	96	123	60	2.1	36.7			
ATUM 33XD3 WCM. 06T308	●	33	32	44	186	99	126	60	1.9	36.8			
ATUM 33.5XD3 WCM. 06T308	●	33.5	32	44	186	99	126	60	1.9	37.3			
ATUM 34XD3 WCM. 06T308	●	34	32	44	189	102	129	60	1.9	37.8			
ATUM 34.5XD3 WCM. 06T308	●	34.5	32	44	189	102	129	60	1.9	38.3			

R: Sağ / Right / Rechts/ L: Sol / Left / Links

● Stokta / In Stock / Auf Lager ○ Stokta Yok / Non Stock Item / Kein Lagerartikel, Lieferzeit auf Anfrage  
ISO Ucuna Uygundur. / Compatible with ISO Insert. / Kompatibel mit ISO Wendeplatten.

Sipariş Örneği/Ordering Example/Bestellbeispiel

1 ad./pcs./stück ATUM 16XD3 WCM. 030208

Takma Uçlu Matkap Kullanım Kılavuzu : S 375 / User's Guide For U-Drills : P 375  
Bedienungsanleitung für Vollbohrer : S 375



Delme Derinliği  
Drilling Depth  
Bohrtiefe

= 3x Çap  
= 3x Diameter  
= 3x Durchmesser

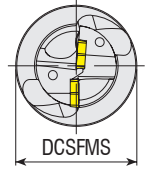
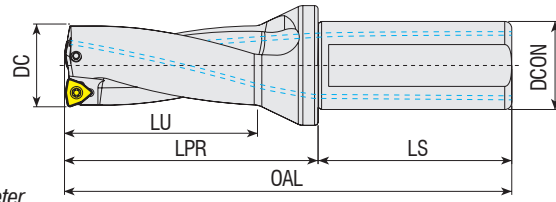

**Takım Kodu**  
**Ordering Code**  
**Bestell-Bezeichnung**

Stok  
Stock  
Lager

Takım Ölçüleri (mm)  
Dimension (mm)  
Abmessung (mm)

Maks. Ofset (radial)  
Max. Offset (radial)  
Max. Versatz (radial)

Kesici Uç  
Insert  
Wendeschneidplatte

Yedek Parçaları / Spare Parts / Ersatzteile

Sıkma Vidası  
Screw  
Schraube

Tork Anahtar  
Torx Key  
Torx-Schlüssel

DC	DCON	DCSFMS	OAL	LU	LPR	LS	X <sub>max</sub> [mm]	DC <sub>max</sub> [mm]
----	------	--------	-----	----	-----	----	-----------------------	------------------------

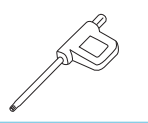

ATUM 35XD3 WCM. 06T308	●	35	32	44	192	105	132	60	1.9	38.8	WCM. 06T308	3010-M3.5x9	82-T10
ATUM 35.5XD3 WCM. 06T308	●	35.5	32	44	192	105	132	60	1.9	39.3			
ATUM 36XD3 WCM. 06T308	●	36	32	44	195	108	135	60	2	40			
ATUM 36.5XD3 WCM. 06T308	●	36.5	32	44	195	108	135	60	2	40.5			
ATUM 37XD3 WCM. 06T308	●	37	32	44	198	111	138	60	1.8	40.6			
ATUM 37.5XD3 WCM. 06T308	●	37.5	32	44	198	111	138	60	1.8	41.1			
ATUM 38XD3 WCM. 06T308	●	38	32	44	201	114	141	60	1.5	41			
ATUM 38.5XD3 WCM. 06T308	●	38.5	32	44	201	114	141	60	1.5	41.5			
ATUM 39XD3 WCM. 06T308	●	39	32	44	204	117	144	60	1.3	41.6			
ATUM 39.5XD3 WCM. 06T308	●	39.5	32	44	204	117	144	60	1.3	42.1			
ATUM 40XD3 WCM. 06T308	●	40	32	44	207	120	147	60	1	42			
ATUM 40.5XD3 WCM. 06T308	●	40.5	32	44	207	120	147	60	1	42.5			
ATUM 41XD3 WCM. 06T308	●	41	32	44	210	123	150	60	0.8	42.6			
ATUM 41.5XD3 WCM. 06T308	●	41.5	32	44	210	123	150	60	0.8	43.1			
ATUM 42XD3 WCM. 06T308	●	42	32	44	213	126	153	60	0.5	43			
ATUM 42.5XD3 WCM. 06T308	●	42.5	32	44	213	126	153	60	0.5	43.5			
ATUM 43XD3 WCM. 06T308	●	43	32	44	216	129	156	60	0.3	43.6			
ATUM 43.5XD3 WCM. 06T308	●	43.5	32	44	216	129	156	60	0.3	44.1			
ATUM 44XD3 WCM. 06T308	●	44	32	44	219	132	159	60	0	44			
ATUM 44.5XD3 WCM. 06T308	●	44.5	32	44	219	132	159	60	0	44.5			
ATUM 45XD3 WCM. 080412	●	45	40	54	237	135	167	70	3.3	51.6	WCM. 080412	4015-M4x11	80-T15
ATUM 45.5XD3 WCM. 080412	●	45.5	40	54	237	135	167	70	3.3	52.1			
ATUM 46XD3 WCM. 080412	●	46	40	54	240	138	170	70	3	52			
ATUM 47XD3 WCM. 080412	●	47	40	54	243	141	173	70	2.8	52.6			
ATUM 48XD3 WCM. 080412	●	48	40	54	246	144	176	70	2.5	53			
ATUM 49XD3 WCM. 080412	●	49	40	54	249	147	179	70	2.2	53.4			
ATUM 50XD3 WCM. 080412	●	50	40	54	252	150	182	70	2	54			
ATUM 51XD3 WCM. 080412	●	51	40	54	255	153	185	70	1.8	54.6			
ATUM 52XD3 WCM. 080412	●	52	40	54	258	156	188	70	1.5	55			
ATUM 53XD3 WCM. 080412	●	53	40	54	261	159	191	70	1.3	55.6			
ATUM 54XD3 WCM. 080412	●	54	40	54	264	162	194	70	1	56			
ATUM 55XD3 WCM. 080412	●	55	40	54	267	165	197	70	0.8	56.6			
ATUM 56XD3 WCM. 080412	●	56	40	64	270	168	200	70	0.5	57			
ATUM 57XD3 WCM. 080412	●	57	40	64	273	171	203	70	0.3	57.6			
ATUM 58XD3 WCM. 080412	●	58	40	64	276	174	206	70	0	58			
ATUM 59XD3 WCM. 080412	●	59	40	64	279	177	209	70	0	59			
ATUM 60XD3 WCM. 080412	●	60	40	64	282	180	212	70	0	60			

R: Sağ / Right / Rechts! L: Sol / Left / Links

● Stokta / In Stock / Auf Lager ○ Stokta Yok / Non Stock Item / Kein Lagerartikel, Lieferzeit auf Anfrage  
ISO Uçuna Uygundur. / Compatible with ISO Insert. / Kompatibel mit ISO Wendepplatten.

Sipariş Örneği/Ordering Example/Bestellbeispiel  
1 ad./pcs./stück ATUM 35XD3 WCM. 06T308

Takma Uçlu Matkap Kullanım Kılavuzu : S 375 / User's Guide For U-Drills : P 375  
Bedienungsanleitung für Vollbohrer : S 375



Delme Derinliği  
Drilling Depth  
Bohrtiefe

= 4x Çap  
= 4x Diameter  
= 4x Durchmesser

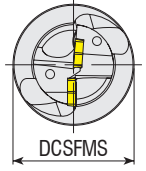
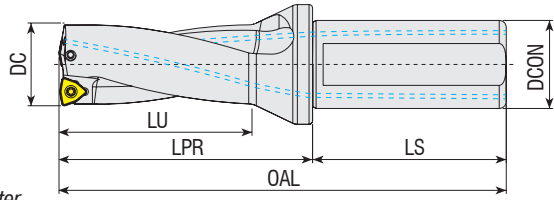

Takım Kodu Ordering Code Bestell-Bezeichnung	Stok Stock Lager	Takım Ölçüleri (mm) Dimension (mm) Abmessung (mm)							Maks. Ofset (radial) Max. Offset (radial) Max. Versatz (radial)		Kesici Uç Insert Wendeschneidplatte	Yedek Parçaları / Spare Parts / Ersatzteile	
		DC	DCON	DCSFMS	OAL	LU	LPR	LS	X <sub>max</sub>	DC <sub>max</sub> [mm]		Sıkma Vidası Screw Schraube	Tork Anahtar Torx Key Torx-Schlüssel
ATUM 16XD4 WCM. 030208	●	16	25	34	142	64	86	56	1.5	19	WCM. 030208		
ATUM 16.5XD4 WCM. 030208	○	16.5	25	34	142	64	86	56	1.5	19.5			
ATUM 17XD4 WCM. 030208	●	17	25	34	146	68	90	56	1.5	20			
ATUM 17.5XD4 WCM. 030208	●	17.5	25	34	146	68	90	56	1.5	20.5			
ATUM 18XD4 WCM. 030208	●	18	25	34	150	72	94	56	1.4	20.8			
ATUM 18.5XD4 WCM. 030208	○	18.5	25	34	150	72	94	56	1.3	21.1			
ATUM 19XD4 WCM. 030208	●	19	25	34	154	76	98	56	1.2	21.4			
ATUM 19.5XD4 WCM. 030208	○	19.5	25	34	154	76	98	56	1.2	21.9			
ATUM 20XD4 WCM. 040208	●	20	25	34	158	80	102	56	1.5	23	WCM. 040208	3008-M2.5x6	82-T08
ATUM 20.5XD4 WCM. 040208	○	20.5	25	34	158	80	102	56	1.5	23.5			
ATUM 21XD4 WCM. 040208	●	21	25	34	162	84	106	56	1	23			
ATUM 21.5XD4 WCM. 040208	○	21.5	25	34	162	84	106	56	1	23.5			
ATUM 22XD4 WCM. 040208	●	22	25	34	166	88	110	56	1	24			
ATUM 22.5XD4 WCM. 040208	●	22.5	25	34	166	88	110	56	1	24.5			
ATUM 23XD4 WCM. 040208	●	23	25	34	170	92	114	56	1	25			
ATUM 23.5XD4 WCM. 040208	○	23.5	25	34	170	92	114	56	1	25.5			
ATUM 24XD4 WCM. 050308	●	24	25	34	174	96	118	56	1.4	26.8	WCM. 050308	3008-M3x8	
ATUM 24.5XD4 WCM. 050308	○	24.5	25	34	174	96	118	56	1.4	27.3			
ATUM 25XD4 WCM. 050308	●	25	25	34	178	100	122	56	1.45	27.9			
ATUM 25.5XD4 WCM. 050308	○	25.5	25	34	178	100	122	56	1.45	28.4			
ATUM 26XD4 WCM. 050308	●	26	25	34	182	104	126	56	1.45	28.9			
ATUM 26.5XD4 WCM. 050308	●	26.5	25	34	182	104	126	56	1.45	29.4			
ATUM 27XD4 WCM. 050308	●	27	25	34	186	108	130	56	1.45	29.9			
ATUM 27.5XD4 WCM. 050308	○	27.5	25	34	186	108	130	56	1.45	30.4			
ATUM 28XD4 WCM. 050308	●	28	25	34	190	112	134	56	1.6	31.2			
ATUM 28.5XD4 WCM. 050308	●	28.5	25	34	190	112	134	56	1.6	31.7			
ATUM 29XD4 WCM. 050308	●	29	25	34	194	116	138	56	1.65	32.3			
ATUM 29.5XD4 WCM. 050308	○	29.5	25	34	194	116	138	56	1.65	32.8			

R: Sağ / Right / Rechts/ L: Sol / Left / Links

● Stokta / In Stock / Auf Lager ○ Stokta Yok / Non Stock Item / Kein Lagerartikel, Lieferzeit auf Anfrage  
ISO Ucuna Uygun. / Compatible with ISO Insert. / Kompatibel mit ISO Wendeschneidplatten.

Sipariş Örneği/Ordering Example/Bestellbeispiel  
1 ad./pcs./stück ATUM 16XD4 WCM. 030208

Takma Uçlu Matkap Kullanım Kılavuzu : S 375 / User's Guide For U-Drills : P 375  
Bedienungsanleitung für Vollbohrer : S 375





Delme Derinliği  
Drilling Depth  
Bohrtiefe

= 4x Çap  
= 4x Diameter  
= 4x Durchmesser

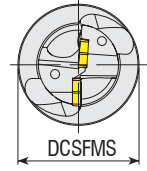
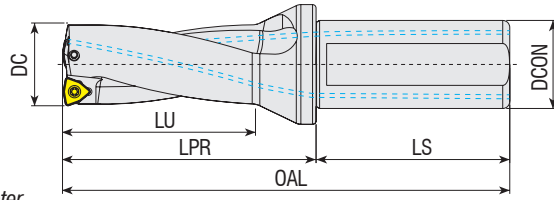

**Takım Kodu**  
**Ordering Code**  
Bestell-Bezeichnung

Stok  
Stock  
Lager

Takım Ölçüleri (mm)  
Dimension (mm)  
Abmessung (mm)

Maks. Ofset (radyal)  
Max. Offset (radial)  
Max. Versatz (radial)

Kesici Uç  
Insert  
Wendeschneidplatte

Yedek Parçaları / Spare Parts / Ersatzteile

Sıkma Vidası  
Screw  
Schraube

Tork Anahtar  
Torx Key  
Torx-Schlüssel

DC

DCON

DCSEMS

OAL

LU

LPR

LS

X<sub>max</sub>

DC<sub>max</sub>

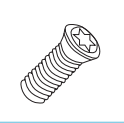

Takım Kodu Ordering Code Bestell-Bezeichnung	Stok Stock Lager	DC	DCON	DCSEMS	OAL	LU	LPR	LS	X <sub>max</sub>	DC <sub>max</sub>	Kesici Uç Insert Wendeschneidplatte	Sıkma Vidası Screw Schraube	Tork Anahtar Torx Key Torx-Schlüssel
ATUM 30XD4 WCM. 06T308	●	30	32	44	207	120	147	60	2.4	34.8	WCM. 06T308	3010-M3.5x9	82-T10
ATUM 31XD4 WCM. 06T308	●	31	32	44	211	124	151	60	2.3	35.6			
ATUM 32XD4 WCM. 06T308	●	32	32	44	215	128	155	60	2.1	36.2			
ATUM 33XD4 WCM. 06T308	●	33	32	44	219	132	159	60	1.9	36.8			
ATUM 33.5XD4 WCM. 06T308	●	33.5	32	44	219	132	159	60	1.9	37.3			
ATUM 34XD4 WCM. 06T308	●	34	32	44	223	136	163	60	1.9	37.8			
ATUM 35XD4 WCM. 06T308	●	35	32	44	227	140	167	60	1.9	38.8			
ATUM 36XD4 WCM. 06T308	●	36	32	44	231	144	171	60	2	40			
ATUM 37XD4 WCM. 06T308	●	37	32	44	235	148	175	60	1.8	40.6			
ATUM 38XD4 WCM. 06T308	●	38	32	44	239	152	179	60	1.5	41			
ATUM 38.5XD4 WCM. 06T308	●	38.5	32	44	239	152	179	60	1.5	41.5			
ATUM 39XD4 WCM. 06T308	●	39	32	44	243	156	183	60	1.3	41.6			
ATUM 40XD4 WCM. 06T308	●	40	32	44	247	160	187	60	1	42			
ATUM 41XD4 WCM. 06T308	●	41	32	44	251	164	191	60	0.8	42.6			
ATUM 42XD4 WCM. 06T308	●	42	32	44	255	168	195	60	0.5	43			
ATUM 43XD4 WCM. 06T308	●	43	32	44	259	172	199	60	0.3	43.6			
ATUM 44XD4 WCM. 06T308	●	44	32	44	263	176	203	60	0	44			
ATUM 45XD4 WCM. 080412	●	45	40	54	282	180	212	70	3.3	51.6	WCM. 080412	4015-M4x11	80-T15
ATUM 46XD4 WCM. 080412	●	46	40	54	286	184	216	70	3	52			
ATUM 47XD4 WCM. 080412	●	47	40	54	290	188	220	70	2.8	52.6			
ATUM 48XD4 WCM. 080412	●	48	40	54	294	192	224	70	2.5	53			
ATUM 49XD4 WCM. 080412	●	49	40	54	298	196	228	70	2.2	53.4			
ATUM 50XD4 WCM. 080412	●	50	40	54	302	200	232	70	2	54			

R: Sağ / Right / Rechts L: Sol / Left / Links

● Stokta / In Stock / Auf Lager ○ Stokta Yok / Non Stock Item / Kein Lagerartikel, Lieferzeit auf Anfrage

ISO Ucuna Uygundur. / Compatible with ISO Insert. / Kompatibel mit ISO Wendeplatten.

Sipariş Örneği/Ordering Example/Bestellbeispiel

1 ad./pcs./stück ATUM 30XD4 WCM. 06T308

Takma Uçlu Matkap Kullanım Kılavuzu : S 375 / User's Guide For U-Drills : P 375

Bedienungsanleitung für Vollbohrer : S 375



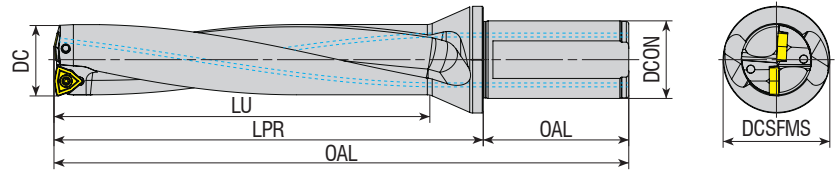

Delme Derinliği  
Drilling Depth  
Bohrtiefe

= 5x Çap  
= 5x Diameter  
= 5x Durchmesser

Takım Kodu Ordering Code Bestell-Bezeichnung	Stok Stock Lager	Takım Ölçüleri (mm) Dimension (mm) Abmessung (mm)							Maks. Ofset (radyal) Max. Offset (radial) Max. Versatz (radial)		Kesici Uç Insert Wendeschneidplatte	Yedek Parçaları / Spare Parts / Ersatzteile	
		DC	DCON	DCSFMS	OAL	LU	LPR	LS	X <sub>max</sub>	DC <sub>max</sub>		Sıkma Vidası Screw Schraube	Tork Anahtar Torx Key Torx-Schlüssel
ATUM 20XD5 WCM. 040208	●	20	25	34	178	100	122	56	1.5	23	WCM. 040208	3008-M2.5x6	82-T08
ATUM 21XD5 WCM. 040208	●	21	25	34	183	105	127	56	1	23			
ATUM 22XD5 WCM. 040208	●	22	25	34	188	110	132	56	1	24			
ATUM 23XD5 WCM. 040208	●	23	25	34	193	115	137	56	1	25			
ATUM 24XD5 WCM. 050308	●	24	25	34	198	120	142	56	1.4	26.8	WCM. 050308	3008-M3x8	82-T08
ATUM 25XD5 WCM. 050308	●	25	25	34	203	125	147	56	1.45	27.9			
ATUM 26XD5 WCM. 050308	●	26	25	34	208	130	152	56	1.45	28.9			
ATUM 27XD5 WCM. 050308	●	27	25	34	213	135	157	56	1.45	29.9			
ATUM 28XD5 WCM. 050308	●	28	25	34	218	140	162	56	1.6	31.2			
ATUM 29XD5 WCM. 050308	●	29	25	34	223	145	167	56	1.65	32.3			
ATUM 30XD5 WCM. 06T308	●	30	32	44	237	150	177	60	2.4	34.8	WCM. 06T308	3010-M3.5x9	82-T10
ATUM 31XD5 WCM. 06T308	●	31	32	44	242	155	182	60	2.3	35.6			
ATUM 32XD5 WCM. 06T308	●	32	32	44	247	160	187	60	2.1	36.2			
ATUM 33XD5 WCM. 06T308	●	33	32	44	252	165	192	60	1.9	36.8			
ATUM 34XD5 WCM. 06T308	●	34	32	44	257	170	197	60	1.9	37.8			
ATUM 35XD5 WCM. 06T308	●	35	32	44	262	175	202	60	1.9	38.8			
ATUM 37XD5 WCM. 06T308	●	37	32	44	272	185	212	60	1.8	40.6			
ATUM 38XD5 WCM. 06T308	●	38	32	44	277	190	217	60	1.5	41			
ATUM 46XD5 WCM. 080412	●	46	40	54	332	230	262	70	3	52	WCM. 080412	4015-M4x11	80-T15

R: Sağ / Right / Rechts L: Sol / Left / Links

● Stokta / In Stock / Auf Lager ○ Stokta Yok / Non Stock Item / Kein Lagerartikel, Lieferzeit auf Anfrage

ISO Ucuna Uygundur. / Compatible with ISO Insert. / Kompatibel mit ISO Wendepplatten.



Delme Derinliği  
Drilling Depth  
Bohrtiefe  
= 2x Çap  
= 2x Diameter  
= 2x Durchmesser

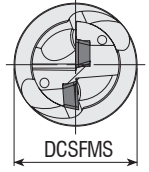
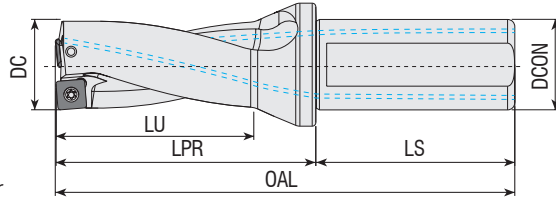

Takım Kodu Ordering Code Bestell-Bezeichnung	Stok Stock Lager	Takım Ölçüleri (mm) Dimension (mm) Abmessung (mm)								Maks. Ofset (radyal) Max. Offset (radial) Max. Versatz (radial)	Kesici Uç Insert Wendeschneidplatte	Yedek Parçaları / Spare Parts / Ersatzteile	
		DC	DCON	DCSFMS	OAL	LU	LPR	LS	Sıkma Vidası Screw Schraube			Tork Anahtar Torx Key Torx-Schlüssel	
ATUM 12.5XD2 SP. 050204	●	12.5	20	25	96	24	46	50	0.75	14	SP. 050204	3006-M2x4	82-T06
ATUM 13XD2 SP. 050204	●	13	20	25	98	26	48	50	0.75	14.5			
ATUM 13.5XD2 SP. 050204	●	13.5	20	25	98	26	48	50	0.75	15			
ATUM 14XD2 SP. 050204	●	14	20	25	100	28	50	50	0.6	15.2			
ATUM 14.5XD2 SP. 050204	●	14.5	20	25	100	28	50	50	0.6	15.7			
ATUM 15XD2 SP. 050204	●	15	20	25	102	30	52	50	0.5	16			
ATUM 15.5XD2 SP. 060204	●	15.5	20	25	102	30	52	50	0.9	17.3	SP. 060204	3007-M2.2x4.6	82-T07
ATUM 16XD2 SP. 060204	●	16	25	34	110	32	54	56	0.8	17.6			
ATUM 16.5XD2 SP. 060204	●	16.5	25	34	110	32	54	56	0.8	18.1			
ATUM 17XD2 SP. 060204	●	17	25	34	112	34	56	56	0.75	18.5			
ATUM 17.5XD2 SP. 060204	●	17.5	25	34	112	34	56	56	0.75	19			
ATUM 18XD2 SP. 060204	●	18	25	34	114	36	58	56	0.5	19			
ATUM 18.5XD2 SP. 060204	●	18.5	25	34	114	36	58	56	0.5	19.5			
ATUM 19XD2 SP. 060204	●	19	25	34	116	38	60	56	0.3	19.6			
ATUM 19.5XD2 SP. 060204	●	19.5	25	34	116	38	60	56	0.3	20.1			
ATUM 20XD2 SP. 060204	●	20	25	34	118	40	62	56	0	20			
ATUM 20.5XD2 SP. 060204	●	20.5	25	34	118	40	62	56	0	20.5			
ATUM 21XD2 SP. 060204	●	21	25	34	120	42	64	56	0	21			
ATUM 21.5XD2 SP. 060204	●	21.5	25	34	120	42	64	56	0	21.5			
ATUM 22XD2 SP. 07T308	●	22	25	34	122	44	66	56	1	24	SP. 07T308	3008-M2.5x6	82-T08
new ATUM 22XD2 SP. 07T308-32	●	22	32	44	131	44	71	60	1	24			
ATUM 22.5XD2 SP. 07T308	●	22.5	25	34	122	44	66	56	1	24.5			
ATUM 23XD2 SP. 07T308	●	23	25	34	124	46	68	56	0.75	24.5			
new ATUM 23XD2 SP. 07T308-32	●	23	32	44	133	46	73	60	0.75	24.5			
ATUM 23.5XD2 SP. 07T308	●	23.5	25	34	124	46	68	56	0.75	25			
ATUM 24XD2 SP. 07T308	●	24	25	34	126	48	70	56	0.5	25			
new ATUM 24XD2 SP. 07T308-32	●	24	32	44	135	48	75	60	0.50	25			
ATUM 24.5XD2 SP. 07T308	●	24.5	25	34	126	48	70	56	0.5	25.5			
ATUM 25XD2 SP. 07T308	●	25	25	34	128	50	72	56	0.25	25.5			
new ATUM 25XD2 SP. 07T308-32	●	25	32	44	137	50	77	60	0.25	25.5			
ATUM 25.5XD2 SP. 07T308	●	25.5	25	34	128	50	72	56	0.25	26			
ATUM 26XD2 SP. 07T308	●	26	25	34	130	52	74	56	0	26			
new ATUM 26XD2 SP. 07T308-32	●	26	32	44	139	52	79	60	0	26			
ATUM 26.5XD2 SP. 07T308	●	26.5	25	34	130	52	74	56	0	26.5			
ATUM 27XD2 SP. 07T308	●	27	25	34	132	54	76	56	0	27			
new ATUM 27XD2 SP. 07T308-32	●	27	32	44	141	54	81	60	0	27			
ATUM 27.5XD2 SP. 07T308	●	27.5	25	34	132	54	76	56	0	27.5			

R: Sağ / Right / Rechtsl L: Sol / Left / Links

● Stokta / In Stock / Auf Lager ○ Stokta Yok / Non Stock Item / Kein Lagerartikel, Lieferzeit auf Anfrage

TGTC Uçuna Uygun. / Compatible with TGTC Insert. / Kompatibel mit TGTC Wendeplatten.

Sipariş Örneği/Ordering Example/Bestellbeispiel

1 ad./pcs./stück ATUM 12.5XD2 SP. 050204

Takma Uçlu Matkap Kullanım Kılavuzu : S 375 / User's Guide For U-Drills : P 375

Bedienungsanleitung für Vollbohrer : S 375



Delme Derinliği  
Drilling Depth  
Bohrtiefe

= 2x Çap  
= 2x Diameter  
= 2x Durchmesser

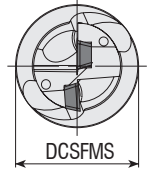
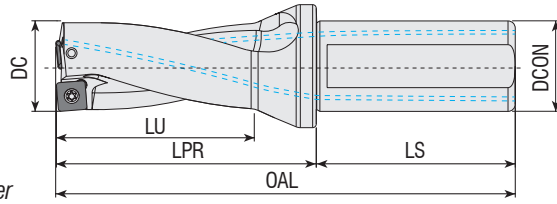

Takım Kodu Ordering Code Bestell-Bezeichnung	Stok Stock Lager	Takım Ölçüleri (mm) Dimension (mm) Abmessung (mm)							Maks. Ofset (radyal) Max. Offset (radial) Max. Versatz (radial)	Kesici Uç Insert Wendeschneidplatte	Yedek Parçaları / Spare Parts / Ersatzteile		
		DC	DCON	DCSFMS	OAL	LU	LPR	LS			Sıkma Vidası Screw Schraube	Tork Anahtar Torx Key Torx-Schlüssel	
ATUM 28XD2 SP. 090408	●	28	25	34	134	56	78	56	1	30	SP. 090408	4015-M3.5x9	80-T15
new ATUM 28XD2 SP. 090408-32	●	28	32	44	143	56	83	60	1	29			
ATUM 28.5XD2 SP. 090408	●	28.5	25	34	134	56	78	56	1	30.5			
ATUM 29XD2 SP. 090408	●	29	25	34	136	58	80	56	0.75	30.5			
new ATUM 29XD2 SP. 090408-32	●	29	32	44	145	58	85	60	0.75	30.5			
ATUM 29.5XD2 SP. 090408	●	29.5	25	34	136	58	80	56	0.75	31			
ATUM 30XD2 SP. 090408	●	30	32	44	147	60	87	60	0.5	31			
ATUM 31XD2 SP. 090408	●	31	32	44	149	62	89	60	0.25	31.5			
ATUM 32XD2 SP. 090408	●	32	32	44	151	64	91	60	0	32			
ATUM 33XD2 SP. 090408	●	33	32	44	153	66	93	60	0	33			
ATUM 34XD2 SP. 110408	●	34	32	44	155	68	95	60	1	36	SP. 110408	4015-M4x11	80-T15
ATUM 35XD2 SP. 110408	●	35	32	44	157	70	97	60	0.75	36.5			
ATUM 36XD2 SP. 110408	●	36	32	44	159	72	99	60	0.6	37.2			
ATUM 37XD2 SP. 110408	●	37	32	44	161	74	101	60	0.5	38			
ATUM 38XD2 SP. 110408	●	38	32	44	163	76	103	60	0.25	38.5			
ATUM 39XD2 SP. 110408	●	39	32	44	165	78	105	60	0	39			
ATUM 40XD2 SP. 110408	●	40	32	44	167	80	107	60	0	40			
ATUM 41XD2 SP. 110408	●	41	32	44	169	82	109	60	0	41			
ATUM 42XD2 SP. 140512	●	42	32	44	171	84	111	60	1.2	44.4			
ATUM 43XD2 SP. 140512	●	43	32	44	173	86	113	60	1	45			
ATUM 44XD2 SP. 140512	●	44	32	44	175	88	115	60	0.8	45.6			
ATUM 45XD2 SP. 140512	●	45	40	54	192	90	122	70	0.6	46.2			
ATUM 46XD2 SP. 140512	●	46	40	54	194	92	124	70	0.4	46.8			
ATUM 47XD2 SP. 140512	●	47	40	54	196	94	126	70	0.2	47.4			
ATUM 48XD2 SP. 140512	●	48	40	54	198	96	128	70	0	48			
ATUM 49XD2 SP. 140512	●	49	40	54	200	98	130	70	0	49			
ATUM 50XD2 SP. 140512	●	50	40	54	202	100	132	70	0	50			

R: Sağ / Right / Rechts/ L: Sol / Left / Links

● Stokta / In Stock / Auf Lager ○ Stokta Yok / Non Stock Item / Kein Lagerartikel, Lieferzeit auf Anfrage  
TGTC Ucuna Uygunudur. / Compatible with TGTC Insert. / Kompatibel mit TGTC Wendepplatten.

Sipariş Örneği/Ordering Example/Bestellbeispiel  
1 ad./pcs./stück ATUM 28XD2 SP. 090408

Takma Uçlu Matkap Kullanım Kılavuzu : S 375 / User's Guide For U-Drills : P 375  
Bedienungsanleitung für Vollbohrer : S 375



Delme Derinliği  
Drilling Depth  
Bohrtiefe

= 3x Çap  
= 3x Diameter  
= 3x Durchmesser

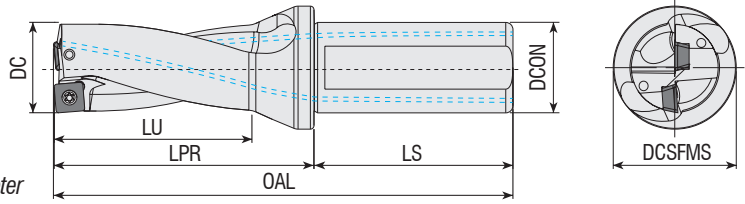

**Takım Kodu**  
**Ordering Code**  
**Bestell-Bezeichnung**

Stok  
Stock  
Lager

Takım Ölçüleri (mm)  
Dimension (mm)  
Abmessung (mm)

Maks. Ofset (radyal)  
Max. Offset (radial)  
Max. Versatz (radial)

Kesici Uç  
Insert  
Wendeschneidplatte

Yedek Parçaları / Spare Parts / Ersatzteile

Sıkma Vidası  
Screw  
Schraube

Tork Anahtar  
Torx Key  
Torx-Schlüssel

DC DCON DCSFMS OAL LU LPR LS X<sub>max</sub> DC<sub>max</sub>



	ATUM	12.5XD3	SP.	050204	●	12.5	20	25	108	36	58	50	0.75	14	SP. 050204	3006-M2x4	82-T06
	ATUM	13XD3	SP.	050204	●	13	20	25	111	39	61	50	0.75	14.5			
	ATUM	13.5XD3	SP.	050204	●	13.5	20	25	111	39	61	50	0.75	15			
	ATUM	14XD3	SP.	050204	●	14	20	25	114	42	64	50	0.6	15.2			
	ATUM	14.5XD3	SP.	050204	●	14.5	20	25	114	42	64	50	0.6	15.7			
	ATUM	15XD3	SP.	050204	●	15	20	25	117	45	67	50	0.5	16			
	ATUM	15.5XD3	SP.	060204	●	15.5	20	25	117	45	67	50	0.9	17.3	SP. 060204	3007-M2.2x4.6	82-T07
	ATUM	16XD3	SP.	060204	●	16	25	34	126	48	70	56	0.8	17.6			
	ATUM	16.5XD3	SP.	060204	●	16.5	25	34	126	48	70	56	0.8	18.1			
	ATUM	17XD3	SP.	060204	●	17	25	34	129	51	73	56	0.75	18.5			
	ATUM	17.5XD3	SP.	060204	●	17.5	25	34	129	51	73	56	0.75	19			
	ATUM	18XD3	SP.	060204	●	18	25	34	132	54	76	56	0.5	19			
	ATUM	18.5XD3	SP.	060204	●	18.5	25	34	132	54	76	56	0.5	19.5			
	ATUM	19XD3	SP.	060204	●	19	25	34	135	57	79	56	0.3	19.6			
	ATUM	19.5XD3	SP.	060204	●	19.5	25	34	135	57	79	56	0.3	20.1			
	ATUM	20XD3	SP.	060204	●	20	25	34	138	60	82	56	0	20			
	ATUM	20.5XD3	SP.	060204	●	20.5	25	34	138	60	82	56	0	20.5			
	ATUM	21XD3	SP.	060204	●	21	25	34	141	63	85	56	0	21			
	ATUM	21.5XD3	SP.	060204	●	21.5	25	34	141	63	85	56	0	21.5			
	ATUM	22XD3	SP.	07T308	●	22	25	34	144	66	88	56	1	24	SP. 07T308	3008-M2.5x6	82-T08
new	ATUM	22XD3	SP.	07T308-32	●	22	32	44	153	66	93	60	1	23			
	ATUM	22.5XD3	SP.	07T308	●	22.5	25	34	144	66	88	56	1	24.5			
	ATUM	23XD3	SP.	07T308	●	23	25	34	147	69	91	56	0.75	24.5			
new	ATUM	23XD3	SP.	07T308-32	●	23	32	44	156	69	96	60	0.75	24.5			
	ATUM	23.5XD3	SP.	07T308	●	23.5	25	34	147	69	91	56	0.75	25			
	ATUM	24XD3	SP.	07T308	●	24	25	34	150	72	94	56	0.5	25			
new	ATUM	24XD3	SP.	07T308-32	●	24	32	44	159	72	99	60	0.50	25			
	ATUM	24.5XD3	SP.	07T308	●	24.5	25	34	150	72	94	56	0.5	25.5			
	ATUM	25XD3	SP.	07T308	●	25	25	34	153	75	97	56	0.25	25.5			
new	ATUM	25XD3	SP.	07T308-32	●	25	32	44	162	75	102	60	0.25	25.5			
	ATUM	25.5XD3	SP.	07T308	●	25.5	25	34	153	75	97	56	0.25	26			
new	ATUM	26XD3	SP.	07T308	●	26	25	34	156	78	100	56	0	26			
new	ATUM	26XD3	SP.	07T308-32	●	26	32	44	165	78	105	60	0	26			
	ATUM	26.5XD3	SP.	07T308	●	26.5	25	34	156	78	100	56	0	26.5			
new	ATUM	27XD3	SP.	07T308	●	27	25	34	159	81	103	56	0	27			
new	ATUM	27XD3	SP.	07T308-32	●	27	32	44	168	81	108	60	0	27			
	ATUM	27.5XD3	SP.	07T308	●	27.5	25	34	159	81	103	56	0	27.5			
new	ATUM	28XD3	SP.	090408	●	28	25	34	162	84	106	56	1	30	SP. 090408	4015-M3.5x9	80-T15
new	ATUM	28XD3	SP.	090408-32	●	28	32	44	171	84	111	60	1	29			
	ATUM	28.5XD3	SP.	090408	●	28.5	25	34	162	84	106	56	1	30.5			
	ATUM	29XD3	SP.	090408	●	29	25	34	165	87	109	56	0.75	30.5			
new	ATUM	29XD3	SP.	090408-32	●	29	32	44	174	87	114	6	0.75	30.5			
	ATUM	29.5XD3	SP.	090408	●	29.5	25	34	165	87	109	56	0.75	31			
	ATUM	30XD3	SP.	090408	●	30	32	44	177	90	117	60	0.5	31			
	ATUM	30.5XD3	SP.	090408	●	30.5	32	44	177	90	117	60	0.5	31.5			
	ATUM	31XD3	SP.	090408	●	31	32	44	180	93	120	60	0.25	31.5			
	ATUM	31.5XD3	SP.	090408	●	31.5	32	44	180	93	120	60	0.25	32			
	ATUM	32XD3	SP.	090408	●	32	32	44	183	96	123	60	0	32			
	ATUM	32.5XD3	SP.	090408	●	32.5	32	44	183	96	123	60	0	32.5			
	ATUM	33XD3	SP.	090408	●	33	32	44	186	99	126	60	0	33			
	ATUM	33.5XD3	SP.	090408	●	33.5	32	44	186	99	126	60	0	33.5			

R: Sağ / Right / Rechts L: Sol / Left / Links

● Stokta / In Stock / Auf Lager ○ Stokta Yok / Non Stock Item / Kein Lagerartikel, Lieferzeit auf Anfrage

TGTC Ucuna Uygundur. / Compatible with TGTC Insert. / Kompatibel mit TGTC Wendeplatten.

Sipariş Örneği/Ordering Example/Bestellbeispiel

1 ad./pcs./stück ATUM 12.5XD3 SP. 050204

Takma Uçlu Matkap Kullanım Kılavuzu : S 375 / User's Guide For U-Drills : P 375

Bedienungsanleitung für Vollbohrer : S 375



Delme Derinliği  
Drilling Depth  
Bohrtiefe  
= 3x Çap  
= 3x Diameter  
= 3x Durchmesser

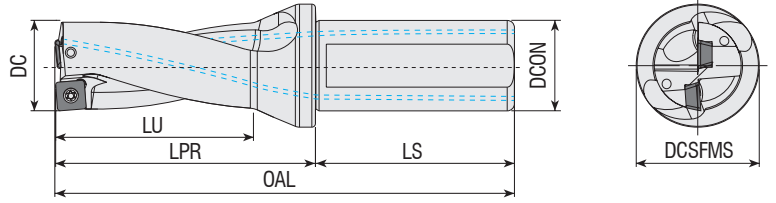

Takım Kodu Ordering Code Bestell-Bezeichnung	Stok Stock Lager	Takım Ölçüleri (mm) Dimension (mm) Abmessung (mm)							Maks. Ofset (radyal) Max. Offset (radial) Max. Versatz (radial)		Kesici Uç Insert Wendeschneidplatte	Yedek Parçaları / Spare Parts / Ersatzteile	
		DC	DCON	DCSFMS	OAL	LU	LPR	LS	X <sub>max</sub>	DC <sub>max</sub>		Sıkma Vidası Screw Schraube	Tork Anahtar Torx Key Torx-Schlüssel
ATUM 34XD3 SP. 110408	●	34	32	44	189	102	129	60	1	36	SP. 110408	4015-M4x11	80-T15
ATUM 34.5XD3 SP. 110408	●	34.5	32	44	189	102	129	60	1	36.5			
ATUM 35XD3 SP. 110408	●	35	32	44	192	105	132	60	0.75	36.5			
ATUM 35.5XD3 SP. 110408	●	35.5	32	44	192	105	132	60	0.75	37			
ATUM 36XD3 SP. 110408	●	36	32	44	195	108	135	60	0.6	37.2			
ATUM 36.5XD3 SP. 110408	●	36.5	32	44	195	108	135	60	0.6	37.7			
ATUM 37XD3 SP. 110408	●	37	32	44	198	111	138	60	0.5	38			
ATUM 37.5XD3 SP. 110408	●	37.5	32	44	198	111	138	60	0.5	38.5			
ATUM 38XD3 SP. 110408	●	38	32	44	201	114	141	60	0.25	38.5			
ATUM 38.5XD3 SP. 110408	●	38.5	32	44	201	114	141	60	0.25	39			
ATUM 39XD3 SP. 110408	●	39	32	44	204	117	144	60	0	39			
ATUM 39.5XD3 SP. 110408	●	39.5	32	44	204	117	144	60	0	39.5			
ATUM 40XD3 SP. 110408	●	40	32	44	207	120	147	60	0	40			
ATUM 40.5XD3 SP. 110408	●	40.5	32	44	207	120	147	60	0	40.5			
ATUM 41XD3 SP. 110408	●	41	32	44	210	123	150	60	0	41			
ATUM 41.5XD3 SP. 110408	●	41.5	32	44	210	123	150	60	0	41.5			
ATUM 42XD3 SP. 140512	●	42	32	44	213	126	153	60	1.2	44.4	SP. 140512	1020-M5x11	80-T20
ATUM 42.5XD3 SP. 140512	●	42.5	32	44	213	126	153	60	1.2	44.9			
ATUM 43XD3 SP. 140512	●	43	32	44	216	129	156	60	1	45			
ATUM 43.5XD3 SP. 140512	●	43.5	32	44	216	129	156	60	1	45.5			
ATUM 44XD3 SP. 140512	●	44	32	44	219	132	159	60	0.8	45.6			
ATUM 44.5XD3 SP. 140512	●	44.5	32	44	219	132	159	60	0.8	46.1			
ATUM 45XD3 SP. 140512	●	45	40	54	237	135	167	70	0.6	46.2			
ATUM 45.5XD3 SP. 140512	●	45.5	40	54	237	135	167	70	0.6	46.7			
ATUM 46XD3 SP. 140512	●	46	40	54	240	138	170	70	0.4	46.8			
ATUM 47XD3 SP. 140512	●	47	40	54	243	141	173	70	0.2	47.4			
ATUM 48XD3 SP. 140512	●	48	40	54	246	144	176	70	0	48			
ATUM 49XD3 SP. 140512	●	49	40	54	249	147	179	70	0	49			
ATUM 50XD3 SP. 140512	●	50	40	54	252	150	182	70	0	50			
ATUM 51XD3 SP. 140512	●	51	40	54	255	153	185	70	0	51			
ATUM 52XD3 SP. 140512	●	52	40	54	258	156	188	70	0	52			

R: Sağ / Right / Rechts/ L: Sol / Left / Links  
● Stokta / In Stock / Auf Lager ○ Stokta Yok / Non Stock Item / Kein Lagerartikel, Lieferzeit auf Anfrage  
TGTC Ucuna Uygunudur. / Compatible with TGTC Insert. / Kompatibel mit TGTC Wendeplatten.

Sipariş Örneği/Ordering Example/Bestellbeispiel  
1 ad./pcs./stück ATUM 34XD3 SP. 110408  
Takma Uçlu Matkap Kullanım Kılavuzu : S 375 / User's Guide For U-Drills : P 375  
Bedienungsanleitung für Vollbohrer : S 375



Delme Derinliği  
Drilling Depth  
Bohrtiefe

= 4x Çap  
= 4x Diameter  
= 4x Durchmesser

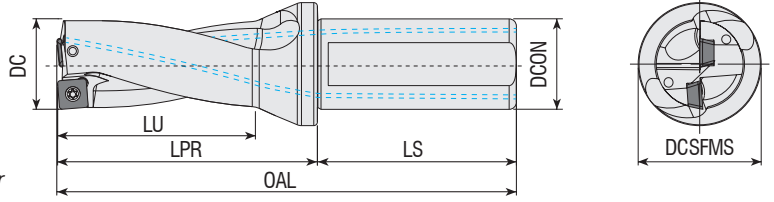

Takım Kodu  
Ordering Code  
Bestell-Bezeichnung

Stok  
Stock  
Lager

Takım Ölçüleri (mm)  
Dimension (mm)  
Abmessung (mm)

Maks. Ofset (radyal)  
Max. Offset (radial)  
Max. Versatz (radial)

Kesici Uç  
Insert  
Wendeschneidplatte

Yedek Parçaları / Spare Parts / Ersatzteile

Sıkma Vidası  
Screw  
Schraube

Tork Anahtar  
Torx Key  
Torx-Schlüssel

DC

DCON

DCSFMS

OAL

LU

LPR

LS

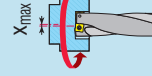

X<sub>max</sub> [mm] DC<sub>max</sub> [mm]



ATUM	13XD4	SP.	050204	●	13	20	25	124	52	74	50	0.75	14.5	SP. 050204	3006-M2x4	82-T06
ATUM	14XD4	SP.	050204	●	14	20	25	128	56	78	50	0.6	15.2			
new	ATUM	14.5XD4	SP.	050204	●	14.5	20	25	128	56	78	0.60	15.7	SP. 060204	3007-M2.2x4.6	82-T07
ATUM	15XD4	SP.	050204	●	15	20	25	132	60	82	50	0.5	16			
ATUM	16XD4	SP.	060204	●	16	25	34	142	64	86	56	0.8	17.6	SP. 07T308	3008-M2.5x6	82-T08
ATUM	17XD4	SP.	060204	●	17	25	34	146	68	90	56	0.75	18.5			
ATUM	17.5XD4	SP.	060204	●	17.5	25	34	146	68	90	56	0.75	19	SP. 07T308	3008-M2.5x6	82-T08
ATUM	18XD4	SP.	060204	●	18	25	34	150	72	94	56	0.5	19			
ATUM	19XD4	SP.	060204	●	19	25	34	154	76	98	56	0.3	19.6	SP. 07T308	3008-M2.5x6	82-T08
ATUM	19.5XD4	SP.	060204	●	19.5	25	34	154	76	98	56	0.3	20.1			
ATUM	20XD4	SP.	060204	●	20	25	34	158	80	102	56	0	20	SP. 07T308	3008-M2.5x6	82-T08
ATUM	21XD4	SP.	060204	●	21	25	34	162	84	106	56	0	21			
ATUM	22XD4	SP.	07T308	●	22	25	34	166	88	110	56	1	24	SP. 07T308	3008-M2.5x6	82-T08
ATUM	23XD4	SP.	07T308	●	23	25	34	170	92	114	56	0.75	24.5			
ATUM	23.5XD4	SP.	07T308	●	23.5	25	34	170	92	114	56	0.75	25	SP. 07T308	3008-M2.5x6	82-T08
ATUM	24XD4	SP.	07T308	●	24	25	34	174	96	118	56	0.5	25			
ATUM	25XD4	SP.	07T308	●	25	25	34	178	100	122	56	0.25	25.5	SP. 07T308	3008-M2.5x6	82-T08
ATUM	26XD4	SP.	07T308	●	26	25	34	182	104	126	56	0	26			
ATUM	27XD4	SP.	07T308	●	27	25	34	186	108	130	56	0	27	SP. 07T308	3008-M2.5x6	82-T08
ATUM	27.5XD4	SP.	07T308	●	27.5	25	34	186	108	130	56	0	27.5			
ATUM	28XD4	SP.	090408	●	28	25	34	190	112	134	56	1	30	SP. 090408	4015-M3.5x9	80-T15
ATUM	29XD4	SP.	090408	●	29	25	34	194	116	138	56	0.75	30.5			
ATUM	30XD4	SP.	090408	●	30	32	44	207	120	147	60	0.5	31	SP. 090408	4015-M3.5x9	80-T15
ATUM	31XD4	SP.	090408	●	31	32	44	211	124	151	60	0.25	31.5			
ATUM	32XD4	SP.	090408	●	32	32	44	215	128	155	60	0	32	SP. 090408	4015-M3.5x9	80-T15
ATUM	33XD4	SP.	090408	●	33	32	44	219	132	159	60	0	33			
ATUM	33.5XD4	SP.	090408	●	33.5	32	44	219	132	159	60	0	33.5	SP. 090408	4015-M3.5x9	80-T15
ATUM	34XD4	SP.	110408	●	34	32	44	223	136	163	60	1	36			
ATUM	35XD4	SP.	110408	●	35	32	44	227	140	167	60	0.75	36.5	SP. 110408	4015-M4x11	80-T15
ATUM	36XD4	SP.	110408	●	36	32	44	231	144	171	60	0.6	37.2			
ATUM	37XD4	SP.	110408	●	37	32	44	235	148	175	60	0.5	38	SP. 110408	4015-M4x11	80-T15
ATUM	38XD4	SP.	110408	●	38	32	44	239	152	179	60	0.25	38.5			
ATUM	39XD4	SP.	110408	●	39	32	44	243	156	183	60	0	39	SP. 110408	4015-M4x11	80-T15
ATUM	40XD4	SP.	110408	●	40	32	44	247	160	187	60	0	40			
ATUM	41XD4	SP.	110408	●	41	32	44	251	164	191	60	0	41	SP. 110408	4015-M4x11	80-T15
ATUM	42XD4	SP.	140512	●	42	32	44	255	168	195	60	1.2	44.4			
ATUM	43XD4	SP.	140512	●	43	32	44	259	172	199	60	1	45	SP. 140512	1020-M5x11	80-T20
ATUM	44XD4	SP.	140512	●	44	32	44	263	176	203	60	0.8	45.6			
new	ATUM	46XD4	SP.	140512	●	46	40	54	286	184	216	0.40	46.8	SP. 140512	1020-M5x11	80-T20

R: Sağ / Right / Rechts | L: Sol / Left / Links

● Stokta / In Stock / Auf Lager ○ Stokta Yok / Non Stock Item / Kein Lagerartikel, Lieferzeit auf Anfrage  
TGTC Ucuna Uygundur. / Compatible with TGTC Insert. / Kompatibel mit TGTC Wendeplatten.

Sipariş Örneği/Ordering Example/Bestellbeispiel

1 ad./pcs./stück ATUM 13XD4 SP. 050204

Takma Uçlu Matkap Kullanım Kılavuzu : S 375 / User's Guide For U-Drills : P 375

Bedienungsanleitung für Vollbohrer : S 375

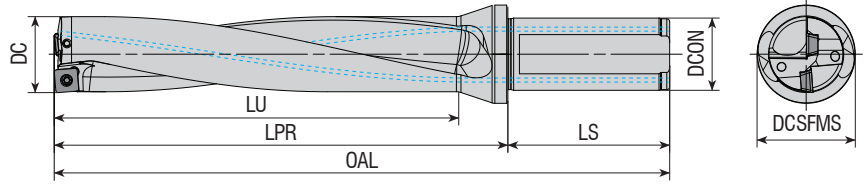

Delme Derinliği  
Drilling Depth  
Bohrtiefe

= 5x Çap  
= 5x Diameter  
= 5x Durchmesser

Takım Kodu Ordering Code Bestell-Bezeichnung	Stok Stock Lager	Takım Ölçüleri (mm) Dimension (mm) Abmessung (mm)							Maks. Ofset (radyal) Max. Offset (radial) Max. Versatz (radial)		Kesici Uç Insert Wendeschneidplatte	Yedek Parçaları / Spare Parts / Ersatzteile	
		DC	DCON	DCSFMS	OAL	LU	LPR	LS	X <sub>max</sub>	DC <sub>max</sub> [mm]		Sıkma Vidası Screw Schraube	Tork Anahtar Torx Key Torx-Schlüssel
<b>new</b> ATUM 13XD5 SP. 050204	●	13	20	25	137	65	87	50	0.75	14.5	SP. 050204	3006-M2.5x4 3006-M2x4 3006-M2.5x4	82-T06
ATUM 14XD5 SP. 050204	●	14	20	25	142	70	92	50	0.6	15.2			
<b>new</b> ATUM 14.5XD5 SP. 050204	●	14.5	20	25	142	70	92	50	0.60	15.7			
<b>new</b> ATUM 15XD5 SP. 050204	●	15	20	25	147	75	97	50	0.50	16	SP. 060204	3007-M2.2x4.6 3007-M2.2x5	82-T07
ATUM 16XD5 SP. 060204	●	16	25	34	158	80	102	56	0.8	17.6			
ATUM 17XD5 SP. 060204	●	17	25	34	163	85	107	56	0.75	18.5			
<b>new</b> ATUM 17XD5 SP. 060204-32	●	17	32	34	163	85	107	56	0.75	18.5	SP. 07T308	3008-M2.5x6	82-T08
ATUM 18XD5 SP. 060204	●	18	25	34	168	90	112	56	0.5	19			
ATUM 19XD5 SP. 060204	●	19	25	34	173	95	117	56	0.3	19.6			
ATUM 20XD5 SP. 060204	●	20	25	34	178	100	122	56	0	20	SP. 090408	4015-M3.5x9	80-T15
ATUM 21XD5 SP. 060204	●	21	25	34	183	105	127	56	0	21			
ATUM 22XD5 SP. 07T308	●	22	25	34	188	110	132	56	1	24			
ATUM 22XD5 SP. 07T308-32	●	22	32	44	197	110	137	60	1	24	SP. 090408	4015-M3.5x9	80-T15
ATUM 23XD5 SP. 07T308	●	23	25	34	193	115	137	56	0.75	24.5			
ATUM 23XD5 SP. 07T308-32	●	23	32	44	202	115	142	60	0.75	24.5			
ATUM 24XD5 SP. 07T308-32	●	24	32	44	207	120	147	60	0.5	25	SP. 090408	4015-M3.5x9	80-T15
ATUM 25XD5 SP. 07T308	●	25	25	34	203	125	147	56	0.25	25.5			
ATUM 25XD5 SP. 07T308-32	●	25	32	44	212	125	152	60	0.25	25.5			
ATUM 26XD5 SP. 07T308	●	26	25	34	208	130	152	56	0	26	SP. 090408	4015-M3.5x9	80-T15
ATUM 26XD5 SP. 07T308-32	●	26	32	44	217	130	157	60	0	26			
ATUM 27XD5 SP. 07T308	●	27	25	34	213	135	157	56	0	27			
ATUM 27XD5 SP. 07T308-32	●	27	32	44	222	135	162	60	0	27	SP. 090408	4015-M3.5x9	80-T15
ATUM 28XD5 SP. 090408-32	●	28	32	44	227	140	167	60	1	30			
ATUM 29XD5 SP. 090408-32	●	29	32	44	232	145	172	60	0.75	30.5			
ATUM 30XD5 SP. 090408	●	30	32	44	237	150	177	60	0.5	31	SP. 090408	4015-M3.5x9	80-T15
ATUM 31XD5 SP. 090408	●	31	32	44	242	155	182	60	0.25	31.5			
ATUM 32XD5 SP. 090408	●	32	32	44	247	160	187	60	0	32			
ATUM 33XD5 SP. 090408	●	33	32	44	252	165	192	60	0	33			

R: Sağ / Right / Rechtsl L: Sol / Left / Links

● Stokta / In Stock / Auf Lager ○ Stokta Yok / Non Stock Item / Kein Lagerartikel, Lieferzeit auf Anfrage  
TGTC Ucuna Uygun / Compatible with TGTC Insert. / Kompatibel mit TGTC Wendeplatten.

Sipariş Örneği/Ordering Example/Bestellbeispiel

1 ad./pcs./stück ATUM 13XD5 SP. 050204

Takma Uçlu Matkap Kullanım Kılavuzu : S 375 / User's Guide For U-Drills : P 375  
Bedienungsanleitung für Vollbohrer : S 375





Delme Derinliği  
Drilling Depth  
Bohrtiefe

= 2x Çap  
= 2x Diameter  
= 2x Durchmesser

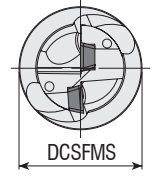
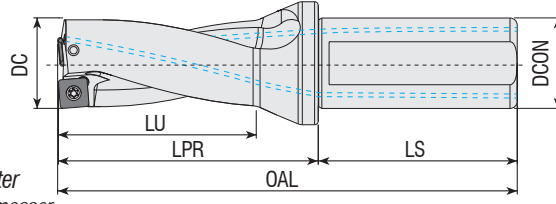

Takım Kodu Ordering Code Bestell-Bezeichnung	Stok Stock Lager	Takım Ölçüleri (mm) Dimension (mm) Abmessung (mm)							Maks. Ofset (radyal) Max. Ofset (radial) Max. Versatz (radial)		Kesici Uç Insert Wendeschneidplatte	Yedek Parçaları / Spare Parts / Ersatzteile	
		DC	DCON	DCSFMS	OAL	LU	LPR	LS	X <sub>max</sub>	DC <sub>max</sub> [mm]		Sıkma Vidası Screw Schraube	Tork Anahtar Torx Key Torx-Schlüssel
ATUM 12.5XD2 SPGT 050204	●	12.5	20	25	96	24	46	50	0.75	14	SPGT 050204	3006-M2x4	82-T06
ATUM 13XD2 SPGT 050204	●	13	20	25	98	26	48	50	0.75	14.5			
ATUM 13.5XD2 SPGT 050204	●	13.5	20	25	98	26	48	50	0.75	15			
ATUM 14XD2 SPGT 050204	●	14	20	25	100	28	50	50	0.6	15.2			
ATUM 15XD2 SPGT 050204	●	15	20	25	102	30	52	50	0.5	16			
ATUM 16XD2 SPGT 060204	●	16	25	34	110	32	54	56	0.8	17.6	SPGT 060204	3007-M2.2x4.6	82-T07
ATUM 16.5XD2 SPGT 060204	●	16.5	25	34	110	32	54	56	0.8	18.1			
ATUM 17XD2 SPGT 060204	●	17	25	34	112	34	56	56	0.75	18.5			
ATUM 17.5XD2 SPGT 060204	●	17.5	25	34	112	34	56	56	0.75	19			
ATUM 18XD2 SPGT 060204	●	18	25	34	114	36	58	56	0.5	19			
ATUM 19XD2 SPGT 060204	●	19	25	34	116	38	60	56	0.3	19.6			
ATUM 20XD2 SPGT 060204	●	20	25	34	118	40	62	56	0	20			
new ATUM 21XD2 SPGT 060204	●	21	25	34	120	42	64	56	0	21			
ATUM 22XD2 SPGT 07T308	●	22	25	34	122	44	66	56	1	24	SPGT 07T308	3008-M2.5x6	82-T08
ATUM 22.5XD2 SPGT 07T308	●	22.5	25	34	122	44	66	56	1	24.5			
ATUM 23XD2 SPGT 07T308	●	23	25	34	124	46	68	56	0.75	24.5			
new ATUM 23.5XD2 SPGT 07T308	●	23.5	25	34	124	46	68	56	0.75	25			
ATUM 24XD2 SPGT 07T308	●	24	25	34	126	48	70	56	0.5	25			
new ATUM 24.5XD2 SPGT 07T308	●	24.5	25	34	126	48	70	56	0.5	25.5			
ATUM 25XD2 SPGT 07T308	●	25	25	34	128	50	72	56	0.25	25.5			
ATUM 26XD2 SPGT 07T308	●	26	25	34	130	52	74	56	0	26			
ATUM 28XD2 SPGT 090408	●	28	25	34	134	56	78	56	1	30	SPGT 090408	4015-M3.5x9	80-T15
ATUM 29XD2 SPGT 090408	●	29	25	34	136	58	80	56	0.75	30.5			
ATUM 30XD2 SPGT 090408	●	30	32	44	147	60	87	60	0.5	31			
new ATUM 31XD2 SPGT 090408	●	31	32	44	149	62	89	60	0.25	31.5			
ATUM 32XD2 SPGT 090408	●	32	32	44	151	64	91	60	0	32			
ATUM 35XD2 SPGT 110408	●	35	32	44	157	70	97	60	0.75	36.5	SPGT 110408	4015-M4x11	80-T15
ATUM 36XD2 SPGT 110408	●	36	32	44	159	72	99	60	0.6	37.2			
ATUM 40XD2 SPGT 110408	●	40	32	44	167	80	107	60	0	40			

R: Sağ / Right / Rechts/ L: Sol / Left / Links  
● Stokta / In Stock / Auf Lager ○ Stokta Yok / Non Stock Item / Kein Lagerartikel, Lieferzeit auf Anfrage  
ZCC Ucuna Uygundur. / Compatible with ZCC Insert. / Kompatibel mit ZCC Wendeplatten.

Sipariş Örneği/Ordering Example/Bestellbeispiel  
1 ad./pcs./stück ATUM 12.5XD2 SPGT 050204

Takma Uçlu Matkap Kullanım Kılavuzu : S 375 / User's Guide For U-Drills : P 375  
Bedienungsanleitung für Vollbohrer : S 375





Delme Derinliği  
Drilling Depth  
Bohrtiefe

= 3x Çap  
= 3x Diameter  
= 3x Durchmesser

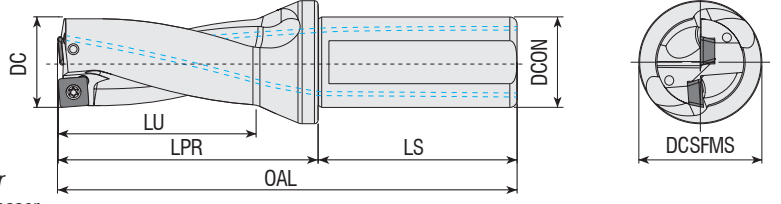

Takım Kodu Ordering Code Bestell-Bezeichnung	Stok Stock Lager	Takım Ölçüleri (mm) Dimension (mm) Abmessung (mm)							Maks. Ofset (radyal) Max. Offset (radial) Max. Versatz (radial)		Kesici Uç Insert Wendeschneidplatte	Yedek Parçaları / Spare Parts / Ersatzteile	
		DC	DCON	DCSFMS	OAL	LU	LPR	LS	X <sub>max</sub>	DC <sub>max</sub>		Sıkma Vidası Screw Schraube	Tork Anahtar Torx Key Torx-Schlüssel
ATUM 12.5XD3 SPGT 050204	●	12.5	20	25	108	36	58	50	0.75	14	SPGT 050204	3006-M2x4	82-T06
ATUM 13XD3 SPGT 050204	●	13	20	25	111	39	61	50	0.75	14.5			
ATUM 13.5XD3 SPGT 050204	●	13.5	20	25	111	39	61	50	0.75	15			
ATUM 14XD3 SPGT 050204	●	14	20	25	114	42	64	50	0.6	15.2			
ATUM 14.5XD3 SPGT 050204	●	14.5	20	25	114	42	64	50	0.6	15.7			
ATUM 15XD3 SPGT 050204	●	15	20	25	117	45	67	50	0.5	16			
ATUM 15.5XD3 SPGT 060204	●	15.5	20	25	117	45	67	50	0.9	17.3	SPGT 060204	3007-M2.2x4.6	82-T07
ATUM 16XD3 SPGT 060204	●	16	25	34	126	48	70	56	0.8	17.6			
ATUM 16.5XD3 SPGT 060204	●	16.5	25	34	126	48	70	56	0.8	18.1			
ATUM 17XD3 SPGT 060204	●	17	25	34	129	51	73	56	0.75	18.5			
ATUM 17.5XD3 SPGT 060204	●	17.5	25	34	129	51	73	56	0.75	19			
ATUM 18XD3 SPGT 060204	●	18	25	34	132	54	76	56	0.5	19			
ATUM 18.5XD3 SPGT 060204	●	18.5	25	34	132	54	76	56	0.5	19.5			
ATUM 19XD3 SPGT 060204	●	19	25	34	135	57	79	56	0.3	19.6			
ATUM 19.5XD3 SPGT 060204	●	19.5	25	34	135	57	79	56	0.3	20.1			
ATUM 20XD3 SPGT 060204	●	20	25	34	138	60	82	56	0	20			
ATUM 20.5XD3 SPGT 060204	●	20.5	25	34	138	60	82	56	0	20.5			
ATUM 21XD3 SPGT 060204	●	21	25	34	141	63	85	56	0	21			
ATUM 21.5XD3 SPGT 060204	●	21.5	25	34	141	63	85	56	0	21.5			
ATUM 22XD3 SPGT 07T308	●	22	25	34	144	66	88	56	1	24	SPGT 07T308	3008-M2.5x6	82-T08
ATUM 22.5XD3 SPGT 07T308	●	22.5	25	34	144	66	88	56	1	24.5			
ATUM 23XD3 SPGT 07T308	●	23	25	34	147	69	91	56	0.75	24.5			
ATUM 23.5XD3 SPGT 07T308	●	23.5	25	34	147	69	91	56	0.75	25			
ATUM 24XD3 SPGT 07T308	●	24	25	34	150	72	94	56	0.5	25			
ATUM 24.5XD3 SPGT 07T308	●	24.5	25	34	150	72	94	56	0.5	25.5			
ATUM 25XD3 SPGT 07T308	●	25	25	34	153	75	97	56	0.25	25.5			
ATUM 25.5XD3 SPGT 07T308	●	25.5	25	34	153	75	97	56	0.25	26			
ATUM 26XD3 SPGT 07T308	●	26	25	34	156	78	100	56	0	26			
ATUM 26.5XD3 SPGT 07T308	●	26.5	25	34	156	78	100	56	0	26.5			
ATUM 27XD3 SPGT 07T308	●	27	25	34	159	81	103	56	0	27			
ATUM 27.5XD3 SPGT 07T308	●	27.5	25	34	159	81	103	56	0	27.5			
ATUM 28XD3 SPGT 090408	●	28	25	34	162	84	106	56	1	30	SPGT 090408	4015-M3.5x9	80-T15
ATUM 28.5XD3 SPGT 090408	●	28.5	25	34	162	84	106	56	1	30.5			
ATUM 29XD3 SPGT 090408	●	29	25	34	165	87	109	56	0.75	30.5			
ATUM 29.5XD3 SPGT 090408	●	29.5	25	34	165	87	109	56	0.75	31			
ATUM 30XD3 SPGT 090408	●	30	32	44	177	90	117	60	0.5	31			
ATUM 31XD3 SPGT 090408	●	31	32	44	180	93	120	60	0.25	31.5			
ATUM 32XD3 SPGT 090408	●	32	32	44	183	96	123	60	0	32			
ATUM 33XD3 SPGT 090408	●	33	32	44	186	99	126	60	0	33			

R: Sağ / Right / Rechts/ L: Sol / Left / Links

● Stokta / In Stock / Auf Lager ○ Stokta Yok / Non Stock Item / Kein Lagerartikel, Lieferzeit auf Anfrage  
ZCC Ucuca Uygun. / Compatible with ZCC Insert. / Kompatibel mit ZCC Wendepfatten.

Sipariş Örneği/Ordering Example/Bestellbeispiel

1 ad./pcs./stück ATUM 12.5XD3 SPGT 050204

Takma Uçlu Matkap Kullanım Kılavuzu : S 375 / User's Guide For U-Drills : P 375

Bedienungsanleitung für Vollbohrer : S 375



Delme Derinliği  
Drilling Depth  
Bohrtiefe  
= 3x Çap  
= 3x Diameter  
= 3x Durchmesser

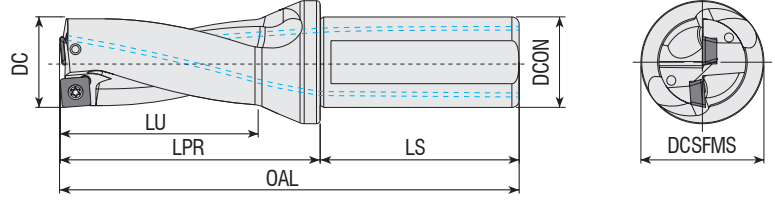

**Takım Kodu**  
**Ordering Code**  
**Bestell-Bezeichnung**

Stok Stock Lager	Takım Ölçüleri (mm) Dimension (mm) Abmessung (mm)								Maks. Ofset (radyal) Max. Offset (radial) Max. Versatz (radial)		Kesici Uç Insert Wendeschneidplatte	Yedek Parçaları / Spare Parts / Ersatzteile	
	DC	DCON	DCSFMS	OAL	LU	LPR	LS	X <sub>max</sub>	DC <sub>max</sub>	Sıkma Vidası Screw Schraube		Tork Anahtar Torx Key Torx-Schlüssel	
●	34	32	44	189	102	129	60	1	36	SPGT 110408	4015-M4x11	80-T15	
●	35	32	44	192	105	132	60	0.75	36.5				
●	36	32	44	195	108	135	60	2.5	41				
●	36.5	32	44	195	110	135	60	0.6	37.7				
●	37	32	44	198	111	138	60	0.5	38				
●	38	32	44	201	114	141	60	0.25	38.5				
●	39	32	44	204	117	144	60	0	39				
●	40	32	44	207	120	147	60	0	40				
●	42	32	44	213	126	153	60	1.2	44.4	SPGT 140512	1020-M5x11	80-T20	
●	43	32	44	216	129	156	60	1	45				
●	44	32	44	219	132	159	60	0.8	45.6				
●	49	40	54	249	147	179	70	0	49				
●	50	40	54	252	150	182	70	0	50				

R: Sağ / Right / Rechts! L: Sol / Left / Links

● Stokta / In Stock / Auf Lager ○ Stokta Yok / Non Stock Item / Kein Lagerartikel, Lieferzeit auf Anfrage  
ZCC Ucuna Uygundur. / Compatible with ZCC Insert. / Kompatibel mit ZCC Wendeplatten.

Sipariş Örneği/Ordering Example/Bestellbeispiel

1 ad./pcs./stück ATUM 34XD3 SPGT 110408

Takma Uçlu Matkap Kullanım Kılavuzu : S 375 / User's Guide For U-Drills : P 375

Bedienungsanleitung für Vollbohrer : S 375





Delme Derinliği  
Drilling Depth  
Bohrtiefe

= 4x Çap  
= 4x Diameter  
= 4x Durchmesser

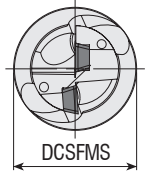
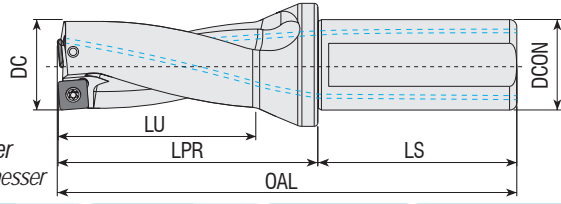

Takım Kodu  
Ordering Code  
Bestell-Bezeichnung

Stok  
Stock  
Lager

Takım Ölçüleri (mm)  
Dimension (mm)  
Abmessung (mm)

Maks. Ofset (radyal)  
Max. Offset (radial)  
Max. Versatz (radial)

Kesici Uç  
Insert  
Wendeschneidplatte

Yedek Parçaları / Spare Parts / Ersatzteile

Sıkma Vidası  
Screw  
Schraube

Tork Anahtar  
Torx Key  
Torx-Schlüssel

DC

DCON

DCSFMS

OAL

LU

LPR

LS

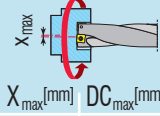

Takım Kodu Ordering Code Bestell-Bezeichnung	Stok Stock Lager	DC	DCON	DCSFMS	OAL	LU	LPR	LS	Maks. Ofset (radyal) Max. Offset (radial) Max. Versatz (radial)	X <sub>max</sub> [mm]	DC <sub>max</sub> [mm]	Kesici Uç Insert Wendeschneidplatte	Sıkma Vidası Screw Schraube	Tork Anahtar Torx Key Torx-Schlüssel
ATUM 13XD4 SPGT 050204	●	13	20	25	124	52	74	50	0.75	14.5		SPGT 050204	3006-M2x4	82-T06
ATUM 14XD4 SPGT 050204	●	14	20	25	128	56	78	50	0.6	15.2				
new ATUM 14.5XD4 SPGT 050204	●	14.5	20	25	128	58	78	50	0.6	15.7				
ATUM 15XD4 SPGT 050204	●	15	20	25	132	60	82	50	0.5	16				
ATUM 16XD4 SPGT 060204	●	16	25	34	142	64	86	56	0.8	17.6		SPGT 060204	3007-M2.2x5	82-T07
ATUM 17XD4 SPGT 060204	●	17	25	34	146	68	90	56	0.75	18.5				
ATUM 17.5XD4 SPGT 060204	●	17.5	25	34	146	68	90	56	0.75	19				
ATUM 18XD4 SPGT 060204	●	18	25	34	150	72	94	56	0.5	19				
ATUM 19XD4 SPGT 060204	●	19	25	34	154	76	98	56	0.3	19.6				
ATUM 19.5XD4 SPGT 060204	●	19.5	25	34	154	76	98	56	0.3	20.1				
ATUM 20XD4 SPGT 060204	●	20	25	34	158	80	102	56	0	20				
ATUM 21XD4 SPGT 060204	●	21	25	34	162	84	106	56	0	21				
ATUM 22XD4 SPGT 07T308	●	22	25	34	166	88	110	56	1	24		SPGT 07T308	3008-M2.5x6	82-T08
ATUM 23XD4 SPGT 07T308	●	23	25	34	170	92	114	56	0.75	24.5				
ATUM 23.5XD4 SPGT 07T308	●	23.5	25	34	170	92	114	56	0.75	25				
ATUM 24XD4 SPGT 07T308	●	24	25	34	174	96	118	56	0.5	25				
ATUM 25XD4 SPGT 07T308	●	25	25	34	178	100	122	56	0.25	25.5				
ATUM 26XD4 SPGT 07T308	●	26	25	34	182	104	126	56	0	26				
ATUM 27.5XD4 SPGT 07T308	●	27.5	25	34	186	108	130	56	0	27.5				
ATUM 28XD4 SPGT 090408	●	28	25	34	190	112	134	56	1	30				
ATUM 29XD4 SPGT 090408	●	29	25	34	194	116	138	56	0.75	30.5				
ATUM 30XD4 SPGT 090408	●	30	32	44	207	120	147	60	0.5	31				
new ATUM 31XD4 SPGT 090408	●	31	32	44	211	124	151	60	0.75	32.5				
new ATUM 32XD4 SPGT 090408	●	32	32	44	215	128	155	60	0	32				
ATUM 33.5XD4 SPGT 090408	●	33.5	32	44	219	132	159	60	0	33.5				
ATUM 38XD4 SPGT 110408	●	38	32	44	239	152	179	60	0.25	38.5		SPGT 110408	4015-M4x11	80-T15

ZCC Ucuna Uygun. / Compatible with ZCC Insert. / Kompatibel mit ZCC Wendeplatten.

Takma Uçlu Matkap Kullanım Kılavuzu : S 375 / User's Guide For U-Drills : P 375  
Bedienungsanleitung für Vollbohrer : S 375



Delme Derinliği  
Drilling Depth  
Bohrtiefe

= 5x Çap  
= 5x Diameter  
= 5x Durchmesser

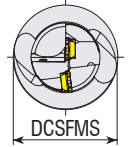
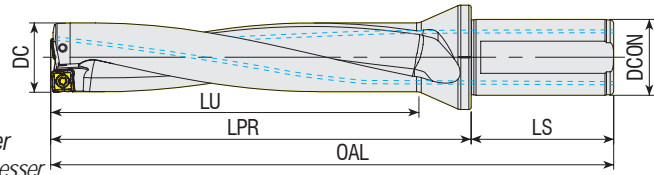

Takım Kodu  
Ordering Code  
Bestell-Bezeichnung

Stok  
Stock  
Lager

Takım Ölçüleri (mm)  
Dimension (mm)  
Abmessung (mm)

Maks. Ofset (radyal)  
Max. Offset (radial)  
Max. Versatz (radial)

Kesici Uç  
Insert  
Wendeschneidplatte

Yedek Parçaları / Spare Parts / Ersatzteile

Sıkma Vidası  
Screw  
Schraube

Tork Anahtar  
Torx Key  
Torx-Schlüssel

DC

DCON

DCSFMS

OAL

LU

LPR

LS

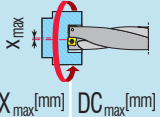

ATUM 22XD5 SPGT 07T308	●	22	25	34	188	110	132	56	1	24		SPGT 07T308	3008-M2.5x6	82-T08
ATUM 26XD5 SPGT 07T308-32	●	26	32	44	217	130	157	60	0	26				

R: Sağ / Right / Rechts/ L: Sol / Left / Links

● Stokta / In Stock / Auf Lager ○ Stokta Yok / Non Stock Item / Kein Lagerartikel, Lieferzeit auf Anfrage  
ZCC Ucuna Uygun. / Compatible with ZCC Insert. / Kompatibel mit ZCC Wendeplatten. Wendeplatten.

Sipariş Örneği/Ordering Example/Bestellbeispiel  
1 ad./pcs./stück ATUM 13XD4 SPGT 050204

Takma Uçlu Matkap Kullanım Kılavuzu : S 375 / User's Guide For U-Drills : P 375  
Bedienungsanleitung für Vollbohrer : S 375



Delme Derinliği  
Drilling Depth  
Bohrtiefe

= 3x Çap  
= 3x Diameter  
= 3x Durchmesser

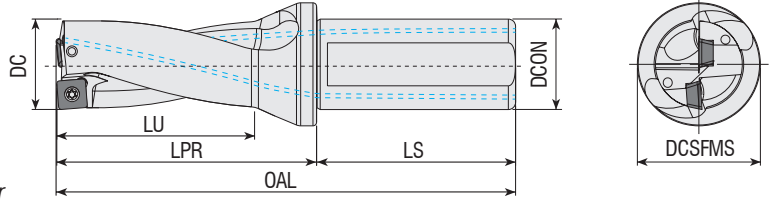

**Takım Kodu**  
**Ordering Code**  
*Bestell-Bezeichnung*

Stok  
Stock  
Lager

Takım Ölçüleri (mm)  
Dimension (mm)  
Abmessung (mm)

Maks. Ofset (radyal)  
Max. Offset (radial)  
Max. Versatz (radial)

Kesici Uç  
Insert  
Wendeschneidplatte

Yedek Parçaları / Spare Parts / Ersatzteile

Sıkma Vidası  
Screw  
Schraube

Tork Anahtar  
Torx Key  
Torx-Schlüssel

	DC	DCON	DCSFMS	OAL	LU	LPR	LS	X <sub>max</sub> [mm]	DC <sub>max</sub> [mm]				
ATUM 14XD3 SO.. 050204	●	14	20	25	114	42	64	50	1.4	16.8	SO.. 050204	3006-M2x4	82-T06
ATUM 15XD3 SO.. 050204	●	15	20	25	117	45	67	50	1.2	17.4			
ATUM 16XD3 SO.. 050204	●	16	25	34	126	48	70	56	0.9	17.8			
ATUM 16.5XD3 SO.. 050204	●	16.5	25	34	126	48	70	56	0.8	18.1			
ATUM 17XD3 SO.. 050204	●	17	25	34	129	51	73	56	0.65	18.3			
ATUM 17.5XD3 SO.. 050204	●	17.5	25	34	129	51	73	56	0.5	18.5			
ATUM 18XD3 SO.. 060304	●	18	25	34	132	54	76	56	1.15	20.3	SO.. 060304	3007-M2.2x4.6	82-T07
ATUM 19XD3 SO.. 060304	●	19	25	34	135	57	79	56	0.9	20.8			
ATUM 20XD3 SO.. 060304	●	20	25	34	138	60	82	56	0.65	21.3			
ATUM 21XD3 SO.. 070305	●	21	25	34	141	63	85	56	1.75	24.5	SO.. 070305	3008-M2.5x6	82-T08
ATUM 22XD3 SO.. 070305	●	22	25	34	144	66	88	56	1.5	25			
ATUM 22.5XD3 SO.. 070305	●	22.5	25	34	144	66	88	56	1.35	25.2			
ATUM 23XD3 SO.. 070305	●	23	25	34	147	69	91	56	1.25	25.5			
ATUM 24XD3 SO.. 070305	●	24	25	34	150	72	94	56	1	26			
ATUM 25XD3 SO.. 09T306	●	25	25	34	153	75	97	56	2.25	29.5			
ATUM 26XD3 SO.. 09T306	●	26	25	34	156	78	100	56	2	30	SO.. 09T306	4010-M3x8	82-T10
ATUM 27XD3 SO.. 09T306	●	27	25	34	159	81	103	56	1.75	30.5			
ATUM 29XD3 SO.. 09T306	●	29	25	34	174	87	114	56	1.25	31.5			
ATUM 30XD3 SO.. 09T306	●	30	32	44	177	90	117	60	1	32			
ATUM 31XD3 SO.. 09T306	●	31	32	44	200	93	120	60	0.75	32.5			
ATUM 33XD3 SO.. 09T306	●	33	32	44	186	99	126	60	0.5	34			
ATUM 35XD3 SO.. 120408	●	35	32	44	192	105	132	60	2.75	40.5	SO..120408	4015-M4X11	80-T15
ATUM 36XD3 SO.. 120408	●	36	32	44	195	108	135	60	2.5	41			
ATUM 37XD3 SO.. 120408	●	37	32	44	198	111	138	60	2.25	41.5			
ATUM 38XD3 SO.. 120408	●	38	32	44	201	114	141	60	1.75	41.5			
ATUM 39XD3 SO.. 120408	●	39	32	44	204	117	144	60	1.75	42.5			
ATUM 40XD3 SO.. 120408	●	40	32	44	207	120	147	60	1.5	43			
ATUM 43XD3 SO.. 120408	●	43	32	44	216	129	156	60	0.75	44.5			

R: Sağ / Right / Rechts/ L: Sol / Left / Links

● Stokta / In Stock / Auf Lager ○ Stokta Yok / Non Stock Item / Kein Lagerartikel, Lieferzeit auf Anfrage  
ISCR Ucuna Uygundur. / Compatible with ISCR Insert. / Kompatibel mit ISCR Wendeplatten.

Sipariş Örneği/Ordering Example/Bestellbeispiel

1 ad./pcs./stück ATUM 14XD3 SO.. 050204

Takma Uçlu Matkap Kullanım Kılavuzu : S 375 / User's Guide For U-Drills : P 375  
Bedienungsanleitung für Vollbohrer : S 375



Delme Derinliği  
Drilling Depth  
Bohrtiefe

= 4x Çap  
= 4x Diameter  
= 4x Durchmesser

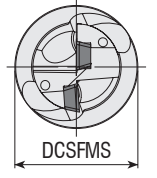
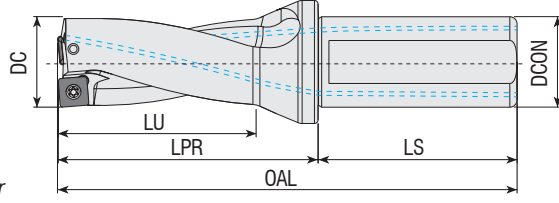

Takım Kodu Ordering Code Bestell-Bezeichnung	Stok Stock Lager	Takım Ölçüleri (mm) Dimension (mm) Abmessung (mm)							Maks. Ofset (radyal) Max. Offset (radial) Max. Versatz (radial)	Kesici Uç Insert Wendeschneidplatte	Yedek Parçaları / Spare Parts / Ersatzteile		
		DC	DCON	DCSFMS	OAL	LU	LPR	LS			Sıkma Vidası Screw Schraube	Tork Anahtar Torx Key Torx-Schlüssel	
ATUM 14XD4 SO.. 050204	●	14	20	25	128	56	78	50	1.4	16.8	SO.. 050204	3006-M2x4	82-T06
ATUM 14.5XD4 SO.. 050204	●	14.5	20	25	128	56	78	50	1.3	17.1			
ATUM 15XD4 SO.. 050204	●	15	20	25	132	60	62	50	1.2	17.4			
ATUM 15.5XD4 SO.. 050204	●	15.5	20	25	132	60	82	50	1	17.5			
ATUM 17XD4 SO.. 050204	●	17	25	34	146	68	90	56	0.65	18.3			
ATUM 19XD4 SO.. 060304	●	19	25	34	154	76	98	56	0.9	20.8	SO.. 060304	3007-M2.2x4.6	82-T07
ATUM 19.5XD4 SO.. 060304	●	19.5	25	34	154	76	98	56	0.75	21			
ATUM 20XD4 SO.. 060304	●	20	25	34	158	80	102	56	0.65	21.3			
ATUM 21XD4 SO.. 070305	●	21	25	34	162	84	106	56	1.75	24.5	SO.. 070305	3008-M2.5x6	82-T08
ATUM 22XD4 SO.. 070305	●	22	25	34	166	88	110	56	1.5	25			
ATUM 22.5XD4 SO.. 070305	●	22.5	25	34	166	88	110	56	1.35	25.2			
ATUM 23XD4 SO.. 070305	●	23	25	34	170	92	114	56	1.25	25.5			
ATUM 24XD4 SO.. 070305	●	24	25	34	174	96	118	56	1	26			
ATUM 25XD4 SO.. 09T306	●	25	25	34	178	100	122	56	2.25	29.5	SO.. 09T306	4010-M3x8	82-T10
ATUM 27XD4 SO.. 09T306	●	27	25	34	186	108	130	56	1.75	30.5			
ATUM 28XD4 SO.. 09T306	●	28	25	34	190	112	134	56	1.5	31			
ATUM 29XD4 SO.. 09T306	●	29	25	34	194	116	138	56	1.25	31.5			
ATUM 30XD4 SO.. 09T306	●	30	32	44	207	120	147	60	1	32			
ATUM 31XD4 SO.. 09T306	●	31	32	44	211	124	151	60	0.75	32.5			
ATUM 33XD4 SO.. 09T306	●	33	32	44	219	132	159	60	0.5	34			
ATUM 34XD4 SO.. 09T306	●	34	32	44	223	136	163	60	0.25	34.5	SO..120408	4015-M4X11	80-T15
ATUM 35XD4 SO.. 120408	●	35	32	44	227	140	167	60	2.75	40.5			

R: Sağ / Right / Rechts/ L: Sol / Left / Links

● Stokta / In Stock / Auf Lager ○ Stokta Yok / Non Stock Item / Kein Lagerartikel, Lieferzeit auf Anfrage  
ISCR Ucuna Uygunudur. / Compatible with ISCR Insert. / Kompatibel mit ISCR Wendeplatten.

Sipariş Örneği/Ordering Example/Bestellbeispiel

1 ad./pcs./stück ATUM 14XD4 SO.. 050204

Takma Uçlu Matkap Kullanım Kılavuzu : S 375 / User's Guide For U-Drills : P 375  
Bedienungsanleitung für Vollbohrer : S 375



Delme Derinliği  
Drilling Depth  
Bohrtiefe

= 2x Çap  
= 2x Diameter  
= 2x Durchmesser

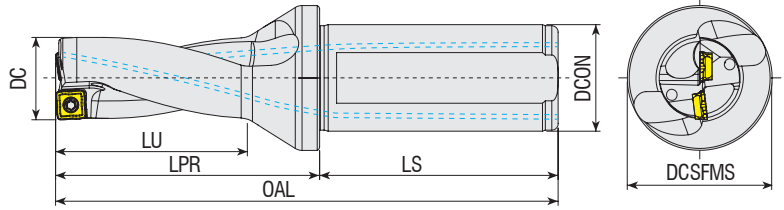

**Takım Kodu**  
**Ordering Code**  
**Bestell-Bezeichnung**

Stok Stock Lager	Takım Ölçüleri (mm) Dimension (mm) Abmessung (mm)								Maks. Ofset (radial) Max. Offset (radial) Max. Versatz (radial)		Kesici Uç Insert Wendeschneidplatte	Yedek Parçaları / Spare Parts / Ersatzteile	
	DC	DCON	DCSFMS	OAL	LU	LPR	LS	X <sub>max</sub>	DC <sub>max</sub>	Sıkma Vidası Screw Schraube		Tork Anahtar Torx Key Torx-Schlüssel	
ATUM 14XD2 SO.. 052704	14	20	25	100	28	50	50	0.60	15.20	SOMX 052704	3006-M2x4.7	82-T08	
ATUM 15XD2 SO.. 052704	15	20	25	102	30	52	50	0.35	15.70				
ATUM 16XD2 SO.. 052704	16	25	34	110	32	54	56	0.25	16.50				
ATUM 17XD2 SO.. 063005	17	25	34	112	34	56	56	0.50	18.00	SOMX 063005	3008-M2.5X6	82-T10	
ATUM 18XD2 SO.. 063005	18	25	34	114	36	58	56	0.40	18.80				
ATUM 19XD2 SO.. 063005	19	25	34	116	38	60	56	0.30	19.60				
ATUM 20XD2 SO.. 073505	20	25	34	118	40	62	56	0.60	21.20	SOMX 073505	4010-M3X6	82-T10	
ATUM 21XD2 SO.. 073505	21	25	34	120	42	64	56	0.50	22.00				
ATUM 22XD2 SO.. 073505	22	25	34	122	44	66	56	0.40	22.80				
ATUM 23XD2 SO.. 084005	23	25	34	124	46	68	56	0.80	24.60	SOMX 084005	3010-M3.5X7	82-T15	
ATUM 24XD2 SO.. 084005	24	25	34	126	48	70	56	0.70	25.40				
ATUM 25XD2 SO.. 084005	25	25	34	128	50	72	56	0.60	26.20				
ATUM 26XD2 SO.. 084005	26	25	34	130	52	74	56	0.50	27.00	SOMX 094506	4015-M4X8	80-T15	
ATUM 28XD2 SO.. 094506	28	25	34	134	56	78	56	0.85	29.70				
ATUM 30XD2 SO.. 094506	30	32	44	147	60	87	60	0.65	31.30				

R: Sağ / Right / Rechts! L: Sol / Left / Links

● Stokta / In Stock / Auf Lager ○ Stokta Yok / Non Stock Item / Kein Lagerartikel, Lieferzeit auf Anfrage  
MTSBH Ucuna Uygunudur. / Compatible with MTSBH Insert. / Kompatibel mit MTSBH.

Sipariş Örneği/Ordering Example/Bestellbeispiel  
1 ad./pcs./шт. ATUM 14XD2 SO.. 052704

Takma Uçlu Matkap Kullanım Kılavuzu : S 375 / User's Guide For U-Drills : P 375  
Bedienungsanleitung für Vollbohrer : S 375





Delme Derinliği  
Drilling Depth  
Bohrtiefe

= 3x Çap  
= 3x Diameter  
= 3x Durchmesser

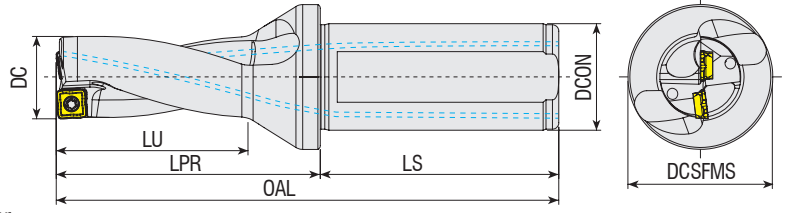

Takım Kodu Ordering Code Bestell-Bezeichnung	Stok Stock Lager	Takım Ölçüleri (mm) Dimension (mm) Abmessung (mm)							Maks. Ofset (radyal) Max. Offset (radial) Max. Versatz (radial)		Kesici Uç Insert Wendeschneidplatte	Yedek Parçaları / Spare Parts / Ersatzteile	
		DC	DCON	DCSFMS	OAL	LU	LPR	LS	X <sub>max</sub>	DC <sub>max</sub>		Sıkma Vidası Screw Schraube	Tork Anahtar Torx Key Torx-Schlüssel
ATUM 14XD3 SO.. 052704	●	14	20	25	114	42	64	50	0.60	15.2	SOMX 052704	3006-M2x4.7	82-T08
ATUM 14.5XD3 SO.. 052704	●	14.5	20	25	114	43.5	64	50	0.50	15.5			
ATUM 15XD3 SO.. 052704	●	15	20	25	117	45	67	50	0.35	15.7			
ATUM 15.5XD3 SO.. 052704	●	16.5	25	34	126	49.5	70	56	0.25	17.0			
ATUM 16XD3 SO.. 052704	●	16	25	34	126	48	70	56	0.25	16.5			
ATUM 16.5XD3 SO.. 052704	●	16.5	25	34	126	49.5	70	56	0.25	17.0			
ATUM 17XD3 SO.. 063005	●	17	25	34	129	51	73	56	0.50	18.0	SOMX 063005	3008-M2.5X6	82-T08
ATUM 17.5XD3 SO.. 063005	●	17.5	25	34	129	52.5	73	56	0.45	18.4			
ATUM 18XD3 SO.. 063005	●	18	25	34	132	54	76	56	0.40	18.8			
ATUM 18.5XD3 SO.. 063005	●	18.5	25	34	132	55.5	76	56	0.35	19.2			
ATUM 19XD3 SO.. 063005	●	19	25	34	135	57	79	56	0.30	19.6			
ATUM 19.5XD3 SO.. 063005	●	19.5	25	34	135	58.5	79	56	0.25	20.0			
ATUM 20XD3 SO.. 073505	●	20	25	34	138	60	82	56	0.60	21.2	SOMX 073505	4010-M3X6	82-T10
ATUM 20.5XD3 SO.. 073505	●	20.5	25	34	138	61.5	82	56	0.55	21.6			
ATUM 21XD3 SO.. 073505	●	21	25	34	141	63	85	56	0.50	22.0			
ATUM 21.5XD3 SO.. 073505	●	21.5	25	34	141	64.5	85	56	0.45	22.4			
ATUM 22XD3 SO.. 073505	●	22	25	34	144	66	88	56	0.40	22.8			
ATUM 22.5XD3 SO.. 073505	●	22.5	25	34	144	67.5	88	56	0.35	23.2			
ATUM 23XD3 SO.. 084005	●	23	25	34	147	69	91	56	0.80	24.6	SOMX 084005	3010-M3.5X7	82-T10
ATUM 23.5XD3 SO.. 084005	●	23.5	25	34	147	70.5	91	56	0.75	25.0			
ATUM 24XD3 SO.. 084005	●	24	25	34	150	72	94	56	0.70	25.4			
ATUM 24.5XD3 SO.. 084005	●	24.5	25	34	150	73.5	94	56	0.65	25.8			
ATUM 25XD3 SO.. 084005	●	25	25	34	153	75	97	56	0.60	26.2			
ATUM 26XD3 SO.. 084005	●	26	25	34	156	78	100	56	0.50	27			
ATUM 27XD3 SO.. 084005	●	27	25	34	159	81	103	56	0.45	27.9	SOMX 094506	4015-M4X8	80-T15
ATUM 28XD3 SO.. 094506	●	28	25	34	162	84	106	56	0.85	29.7			
ATUM 29XD3 SO.. 094506	●	29	25	34	165	87	109	56	0.75	30.5			
ATUM 30XD3 SO.. 094506	●	30	32	44	177	90	117	60	0.65	31.3			
ATUM 32XD3 SO.. 094506	●	32	32	44	183	96	123	60	0.45	32.9			

R: Sağ / Right / Rechts/ L: Sol / Left / Links

● Stokta / In Stock / Auf Lager ○ Stokta Yok / Non Stock Item / Kein Lagerartikel, Lieferzeit auf Anfrage  
MTSBH Ucuna Uygundur. / Compatible with MTSBH Insert. / Kompatibel mit MTSBH.

Sipariş Örneği/Ordering Example/Bestellbeispiel  
1 ad./pcs./stück ATUM 14.5XD3 SO.. 052704

Takma Uçlu Matkap Kullanım Kılavuzu : S 375 / User's Guide For U-Drills : P 375  
Bedienungsanleitung für Vollbohrer : S 375





Delme Derinliği  
Drilling Depth  
Bohrtiefe

= 4x Çap  
= 4x Diameter  
= 4x Durchmesser

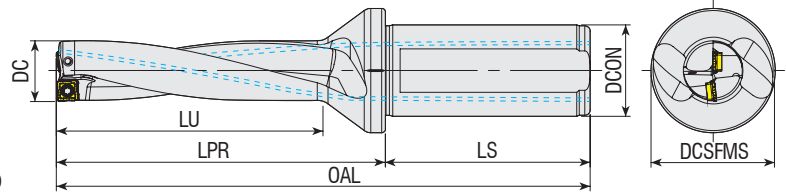

**Takım Kodu**  
**Ordering Code**  
**Bestell-Bezeichnung**

Stok Stock Lager	Takım Ölçüleri (mm) Dimension (mm) Abmessung (mm)								Maks. Ofset (radial) Max. Offset (radial) Max. Versatz (radial)		Kesici Uç Insert Wendeschneidplatte	Yedek Parçaları / Spare Parts / Ersatzteile	
	DC	DCON	DCSFMS	OAL	LU	LPR	LS	X <sub>max</sub>	DC <sub>max</sub>	Sıkma Vidası Screw Schraube		Tork Anahtar Torx Key Torx-Schlüssel	
ATUM 14XD4 SO.. 052704	●	14	20	25	128	56	78	50	0.60	15.2	SOMX 052704	3006-M2x4.7	82-T08
ATUM 15XD4 SO.. 052704	●	15	20	25	132	60	82	50	0.35	15.7			
ATUM 16XD4 SO.. 052704	●	16	25	34	142	64	86	56	0.25	16.5	SOMX 063005	3008-M2.5X6	82-T08
ATUM 17XD4 SO.. 063005	●	17	25	34	146	68	90	56	0.50	18.0			
ATUM 18XD4 SO.. 063005	●	18	25	34	150	72	94	56	0.40	18.8	SOMX 073505	4010-M3X6	82-T10
ATUM 19XD4 SO.. 063005	●	19	25	34	154	76	98	56	0.30	19.6			
ATUM 20XD4 SO.. 073505	●	20	25	34	158	80	102	56	0.60	21.2	SOMX 084005	3010-M3.5X7	80-T15
ATUM 21XD4 SO.. 073505	●	21	25	34	162	84	106	56	0.50	22.0			
ATUM 22XD4 SO.. 073505	●	22	25	34	166	88	110	56	0.40	22.8	SOMX 094506	4015-M4X8	80-T15
ATUM 23XD4 SO.. 084005	●	23	25	34	170	92	114	56	0.80	24.6			
ATUM 24XD4 SO.. 084005	●	24	25	34	174	96	118	56	0.70	25.4	SOMX 094506	4015-M4X8	80-T15
ATUM 25XD4 SO.. 084005	●	25	25	34	178	100	122	56	0.60	26.2			
ATUM 26XD4 SO.. 084005	●	26	25	34	182	104	126	56	0.50	27.0	SOMX 094506	4015-M4X8	80-T15
ATUM 28XD4 SO.. 094506	●	28	25	34	190	112	134	56	0.85	29.7			
ATUM 30XD4 SO.. 094506	●	30	32	44	207	120	147	60	0.65	31.3	SOMX 094506	4015-M4X8	80-T15
ATUM 30XD4 SO.. 094506	●	30	32	44	207	120	147	60	0.65	31.3			

R: Sağ / Right / Rechts / L: Sol / Left / Links

● Stokta / In Stock / Auf Lager ○ Stokta Yok / Non Stock Item / Kein Lagerartikel, Lieferzeit auf Anfrage  
MTSBH Ucuna Uygunudur. / Compatible with MTSBH Insert. / Kompatibel mit MTSBH.

Sipariş Örneği/Ordering Example/Bestellbeispiel

1 ad./pcs./stück ATUM 14XD4 SO.. 052704

Takma Uçlu Matkap Kullanım Kılavuzu : S 375 / User's Guide For U-Drills : P 375

Bedienungsanleitung für Vollbohrer : S 375





Delme Derinliği  
Drilling Depth  
Bohrtiefe

= 2x Çap  
= 2x Diameter  
= 2x Durchmesser

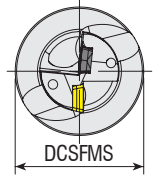
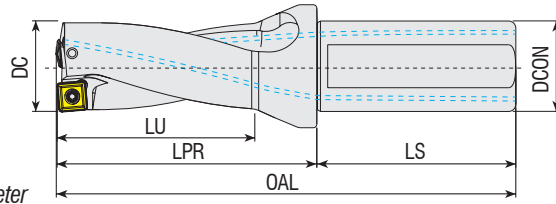

Takım Kodu  
Ordering Code  
Bestell-Bezeichnung

Stok Stock Lager	Takım Ölçüleri (mm) Dimension (mm) Abmessung (mm)								Maks. Ofset (radyal) Max. Offset (radial) Max. Versatz (radial)		Kesici Uç Insert Wendeschneidplatte	Yedek Parçaları / Spare Parts / Ersatzteile	
	DC	DCON	DCSFMS	OAL	LU	LPR	LS	X <sub>max</sub> X <sub>max</sub> [mm]	DC <sub>max</sub> DC <sub>max</sub> [mm]	Sıkma Vidası Screw Schraube		Tork Anahtar Torx Key Torx-Schlüssel	
●	14	20	25	100	28	50	50	0.25	14.5	SPMT 050204-XOMT 050204	3006-M2x4	82-T06	
●	18	25	34	114	36	58	56	0.5	19	SPMT 060205-XOMT 060204	3007-M2.2x4.6	82-T07	
●	20	25	34	118	40	62	56	0.3	20.6	SPMT 07T208 XOMT 07T205	3008-M2.5x6	82-T08	
●	22	25	34	122	44	66	56	0.3	22.6	SPMT 090308 XOMT 090305	3008-M3x7		
●	24	25	34	126	48	70	56	0.3	24.6				
●	25	25	34	128	50	72	56	0.3	25.6				
●	26	25	34	130	52	74	56	0.3	26.6				
●	28	25	34	134	56	78	56	0.3	28.6				
●	30	25	34	147	60	87	60	0.35	30.7	SPMT 11T308 XOMT 11T306	4015-M3.5x9	80-T15	
●	32	32	44	151	64	91	60	0.35	32.7				
●	34	32	44	155	68	95	60	0.35	34.7				
●	36	32	44	159	72	99	60	0.35	36.7	SPMT 130410 XOMT 130406	4015-M4x11		
●	37	32	44	161	74	101	60	0.35	37.7				
●	38	32	44	163	76	103	60	0.35	38.7				

KRLY Ucuna Uygunur. / Compatible with KRLY Insert. / Kompatibel mit KRYL



Delme Derinliği  
Drilling Depth  
Bohrtiefe

= 4x Çap  
= 4x Diameter  
= 4x Durchmesser

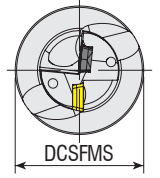
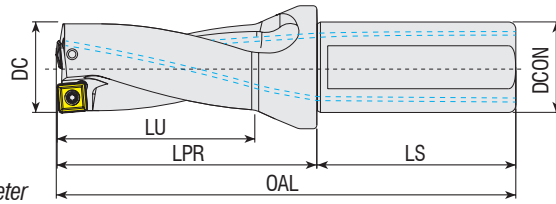

Takım Kodu  
Ordering Code  
Bestell-Bezeichnung

Stok Stock Lager	Takım Ölçüleri (mm) Dimension (mm) Abmessung (mm)								Maks. Ofset (radyal) Max. Offset (radial) Max. Versatz (radial)		Kesici Uç Insert Wendeschneidplatte	Yedek Parçaları / Spare Parts / Ersatzteile	
	DC	DCON	DCSFMS	OAL	LU	LPR	LS	X <sub>max</sub> X <sub>max</sub> [mm]	DC <sub>max</sub> DC <sub>max</sub> [mm]	Sıkma Vidası Screw Schraube		Tork Anahtar Torx Key Torx-Schlüssel	
●	14	20	25	128	56	78	50	0.25	14.5	SPMT 050204 XOMT 050204	3006-M2x4	82-T06	
●	14.5	20	25	128	56	78	50	0.25	15				
●	15	20	25	132	60	82	50	0.25	15.5				
●	15.5	20	25	132	60	82	50	0.25	16				
●	16	25	34	142	64	86	56	0.25	16.5				
●	17	25	34	146	68	90	56	0.5	18	SPMT 060205 XOMT 060204	3007-M2.2x4.6	82-T07	
●	17.5	25	34	146	68	90	56	0.5	18.5				
●	18	25	34	150	72	94	56	0.5	19				
●	18.5	25	34	150	72	94	56	0.5	19.5				
●	19	25	34	154	76	98	56	0.5	20				
●	20	25	34	158	80	102	56	0.3	20.6	SPMT 07T208 XOMT 07T205	3008-M2.5x6	82-T08	
●	21	25	34	162	84	106	56	0.3	21.6				
●	22	25	34	166	88	110	56	0.3	22.6				
●	24	25	34	174	96	118	56	0.3	24.6	SPMT 090308 XOMT 090305	3008-M3x7		
●	25	25	34	178	100	122	56	0.3	25.6				

R: Sağ / Right / Rechts/ L: Sol / Left / Links

● Stokta / In Stock / Auf Lager ○ Stokta Yok / Non Stock Item / Kein Lagerartikel, Lieferzeit auf Anfrage

KRLY Ucuna Uygunur. / Compatible with KRLY Insert. / Kompatibel mit KRYL

Sipariş Örneği/Ordering Example/Bestellbeispiel

1 ad./pcs./stück ATUM 14XD2 KDR 0502..

Takma Uçlu Matkap Kullanım Kılavuzu : S 375 / User's Guide For U-Drills : P 375

Bedienungsanleitung für Vollbohrer : S 375



Delme Derinliği  
Drilling Depth  
Bohrtiefe

= 3x Çap  
= 3x Diameter  
= 3x Durchmesser

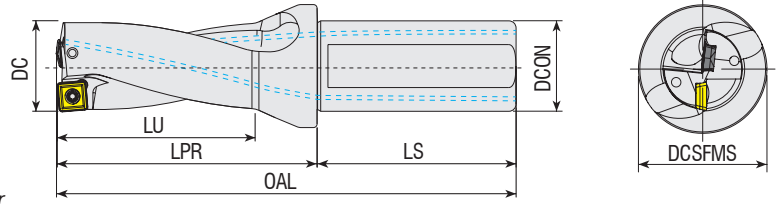

**Takım Kodu**  
**Ordering Code**  
**Bestell-Bezeichnung**

Stok  
Stock  
Lager

Takım Ölçüleri (mm)  
Dimension (mm)  
Abmessung (mm)

Maks. Ofset (radial)  
Max. Offset (radial)  
Max. Versatz (radial)

Kesici Uç  
Insert  
Wendeschneidplatte

Yedek Parçaları / Spare Parts / Ersatzteile

Sıkma Vidası  
Screw  
Schraube

Tork Anahtar  
Torx Key  
Torx-Schlüssel



ATUM	DC	DCON	DCSFMS	OAL	LU	LPR	LS	X <sub>max</sub>	DC <sub>max</sub>	Kesici Uç Insert Wendeschneidplatte	Sıkma Vidası Screw Schraube	Tork Anahtar Torx Key Torx-Schlüssel
ATUM 12.5XD3 KDR 0402..	12.5	20	25	108	36	58	50	0.2	12.9	SPMT 040204 XOMT 040204	3006-M2x4	82-T06
ATUM 13XD3 KDR 0402..	13	20	25	111	39	61	50	0.2	13.4			
ATUM 14XD3 KDR 0502..	14	20	25	114	42	64	50	0.25	14.5	SPMT 050204 XOMT 050204	3006-M2x4	82-T06
ATUM 14.5XD3 KDR 0502..	14.5	20	25	114	42	64	50	0.25	15			
ATUM 15XD3 KDR 0502..	15	20	25	117	45	67	50	0.25	15.5	SPMT 060205 XOMT 060204	3007-M2.2x4.6	82-T07
ATUM 15.5XD3 KDR 0502..	15.5	20	25	117	45	67	50	0.25	16			
ATUM 16XD3 KDR 0502..	16	25	34	126	48	70	56	0.25	16.5	SPMT 060205 XOMT 060204	3007-M2.2x4.6	82-T07
ATUM 16.5XD3 KDR 0602..	16.5	25	34	126	48	70	56	0.5	17.5			
ATUM 17XD3 KDR 0602..	17	25	34	129	51	73	56	0.5	18	SPMT 060205 XOMT 060204	3007-M2.2x4.6	82-T07
ATUM 17.5XD3 KDR 0602..	17.5	25	34	129	51	73	56	0.5	18.5			
ATUM 18XD3 KDR 0602..	18	25	34	132	54	76	56	0.5	19	SPMT 060205 XOMT 060204	3007-M2.2x4.6	82-T07
ATUM 18.5XD3 KDR 0602..	18.5	25	34	132	54	76	56	0.5	19.5			
ATUM 19XD3 KDR 0602..	19	25	34	135	57	79	56	0.5	20	SPMT 060205 XOMT 060204	3007-M2.2x4.6	82-T07
ATUM 19.5XD3 KDR 0602..	19.5	25	34	135	57	79	56	0.5	20.5			
ATUM 20XD3 KDR 07T2..	20	25	34	138	60	82	56	0.3	20.6	SPMT 07T208 XOMT 07T205	3008-M2.5x6	82-T08
ATUM 20.5XD3 KDR 07T2..	20.5	25	34	138	60	82	56	0.3	21.1			
ATUM 21XD3 KDR 07T2..	21	25	34	141	63	85	56	0.3	21.6	SPMT 07T208 XOMT 07T205	3008-M2.5x6	82-T08
ATUM 22XD3 KDR 07T2..	22	25	34	144	66	88	56	0.3	22.6			
ATUM 22.5XD3 KDR 07T2..	22.5	25	34	144	68	88	56	0.3	23.1	SPMT 090308 XOMT 090305	3008-M3x7	82-T08
ATUM 23XD3 KDR 07T2..	23	25	34	147	69	91	56	0.3	23.6			
ATUM 23.5XD3 KDR 07T2..	23.5	25	34	147	69	91	56	0.3	24.1	SPMT 090308 XOMT 090305	3008-M3x7	82-T08
ATUM 24XD3 KDR 0903..	24	25	34	150	72	94	56	0.3	24.6			
ATUM 24.5XD3 KDR 0903..	24.5	25	34	150	72	94	56	0.3	25.1	SPMT 090308 XOMT 090305	3008-M3x7	82-T08
ATUM 25XD3 KDR 0903..	25	25	34	153	75	97	56	0.3	25.6			
ATUM 26XD3 KDR 0903..	26	25	34	156	78	100	56	0.3	26.6	SPMT 090308 XOMT 090305	3008-M3x7	82-T08
ATUM 27XD3 KDR 0903..	27	25	34	159	81	103	56	0.3	27.6			
ATUM 28XD3 KDR 0903..	28	25	34	162	84	106	56	0.3	28.6	SPMT 11T308 XOMT 11T306	4015-M3.5x9	80-T15
ATUM 29XD3 KDR 0903..	29	25	34	165	87	109	56	0.3	29.6			
ATUM 30XD3 KDR 11T3..	30	32	44	177	90	117	60	0.35	30.7	SPMT 11T308 XOMT 11T306	4015-M3.5x9	80-T15
ATUM 32XD3 KDR 11T3..	32	32	44	183	96	123	60	0.35	32.7			
ATUM 33XD3 KDR 11T3..	33	32	44	186	99	126	60	0.35	33.7	SPMT 130410 XOMT 130406	4015-M4x11	80-T15
ATUM 34XD3 KDR 11T3..	34	32	44	189	102	129	60	0.35	34.7			
ATUM 35XD3 KDR 11T3..	35	32	44	192	105	132	60	0.35	35.7	SPMT 130410 XOMT 130406	4015-M4x11	80-T15
ATUM 37XD3 KDR 1304..	37	32	44	198	111	138	60	0.35	37.7			
ATUM 38XD3 KDR 1304..	38	32	44	201	114	141	60	0.35	38.7	SPMT 130410 XOMT 130406	4015-M4x11	80-T15
ATUM 39XD3 KDR 1304..	39	32	44	204	117	144	60	0.35	39.7			
ATUM 40XD3 KDR 1304..	40	32	44	207	120	147	60	0.35	40.7	SPMT 130410 XOMT 130406	4015-M4x11	80-T15

R: Sağ / Right / Rechts/ L: Sol / Left / Links

● Stokta / In Stock / Auf Lager ○ Stokta Yok / Non Stock Item / Kein Lagerartikel, Lieferzeit auf Anfrage  
KRLY Uçuna Uygun. / Compatible with KRLY Insert. / Kompatibel mit KRLY

Sipariş Örneği/Ordering Example/Bestellbeispiel  
1 ad./pcs./stück ATUM 12.5XD3 KDR 0402..

Takma Uçlu Matkap Kullanım Kılavuzu : S 375 / User's Guide For U-Drills : P 375  
Bedienungsanleitung für Vollbohrer : S 375



Delme Derinliği  
Drilling Depth  
Bohrtiefe  
= 2x Çap  
= 2x Diameter  
= 2x Durchmesser

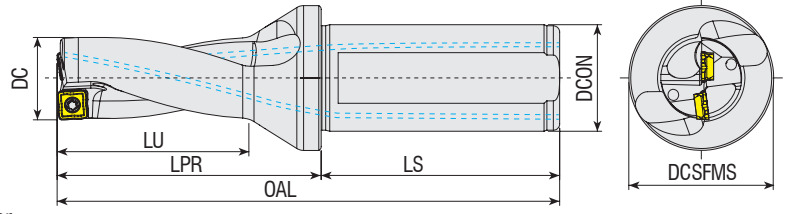

Takım Kodu Ordering Code Bestell-Bezeichnung	Stok Stock Lager	Takım Ölçüleri (mm) Dimension (mm) Abmessung (mm)							Maks. Ofset (radyal) Max. Offset (radial) Max. Versatz (radial)		Kesici Uç Insert Wendeschneidplatte	Yedek Parçaları / Spare Parts / Ersatzteile		
		DC	DCON	DCSEMS	OAL	LU	LPR	LS	X <sub>max</sub> [mm]	DC <sub>max</sub> [mm]		Sıkma Vidası Screw Schraube	Tork Anahtar Torx Key Torx-Schlüssel	
ATUM 14XD2 SOMT 050204	●	14	20	25	100	28	50	50	0.5	15	SOMT 050204	3006-M2x4	82-T06	
ATUM 16XD2 SOMT 050204	●	16	25	34	110	32	54	56	0.3	16.6	SOMT 060204	3007-M2.2x4.6	82-T07	
ATUM 17XD2 SOMT 060204	●	17	25	34	112	34	56	56	0.5	18				
ATUM 18XD2 SOMT 060204	●	18	25	34	114	36	58	56	0.4	18.8	SOMT 070306	3008-M2.5x6	82-T08	
ATUM 20XD2 SOMT 070306	●	20	25	34	118	40	62	56	0.5	21				
ATUM 22XD2 SOMT 070306	●	22	25	34	122	44	66	56	0.3	22.6	SOMT 08T306	4015-M3.5x9	80-T15	
ATUM 23XD2 SOMT 08T306	●	23	25	34	124	46	68	56	0.5	24				
ATUM 24XD2 SOMT 08T306	●	24	25	34	126	48	70	56	0.5	25	SOMT 09T308	4015-M4x11	80-T20	
ATUM 25XD2 SOMT 08T306	●	25	25	34	128	50	72	56	0.4	25.8				
ATUM 26XD2 SOMT 08T306	●	26	25	34	130	52	74	56	0.3	26.6	SOMT 11T308	1020-M5x11	80-T20	
ATUM 27XD2 SOMT 09T308	●	27	25	34	132	54	76	56	0.5	28				
ATUM 28XD2 SOMT 09T308	●	28	25	34	134	56	78	56	0.5	29	SOMT 130408	1020-M5x11	80-T20	
ATUM 29XD2 SOMT 09T308	●	29	25	34	136	58	80	56	0.5	30				
ATUM 30XD2 SOMT 09T308	●	30	32	44	147	60	87	60	0.5	31	SOMT 150510	1020-M5x11	80-T20	
ATUM 32XD2 SOMT 11T308	●	32	32	44	151	64	91	60	0.5	33				
ATUM 33XD2 SOMT 11T308	●	33	32	44	153	66	93	60	0.5	34	SOMT 150510	1020-M5x11	80-T20	
ATUM 34XD2 SOMT 11T308	●	34	32	44	155	68	95	60	0.5	35				
ATUM 35XD2 SOMT 11T308	●	35	32	44	157	70	97	60	0.5	36	SOMT 150510	1020-M5x11	80-T20	
ATUM 37XD2 SOMT 130408	●	37	32	44	161	74	101	60	0.5	38				
ATUM 38XD2 SOMT 130408	●	38	32	44	163	76	103	60	0.5	39	SOMT 150510	1020-M5x11	80-T20	
ATUM 40XD2 SOMT 130408	●	40	32	44	167	80	107	60	0.5	41				
ATUM 45XD2 SOMT 150510	●	45	40	54	192	90	122	70	0.5	46	SOMT 150510	1020-M5x11	80-T20	
ATUM 47XD2 SOMT 150510	●	47	40	54	196	94	126	70	0.5	48				

R: Sağ / Right / Rechts | L: Sol / Left / Links  
● Stokta / In Stock / Auf Lager ○ Stokta Yok / Non Stock Item / Kein Lagerartikel, Lieferzeit auf Anfrage  
TGTC Ucuna Uygunur. / Compatible with TGTC Insert. / Kompatibel mit TGTC Wendeplatten.

Sipariş Örneği/Ordering Example/Bestellbeispiel  
1 ad./pcs./stück ATUM 14XD2 SOMT 050204

Takma Uçlu Matkap Kullanım Kılavuzu : S 375 / User's Guide For U-Drills : P 375  
Bedienungsanleitung für Vollbohrer : S 375



Delme Derinliği  
Drilling Depth  
Bohrtiefe = 3x Çap  
= 3x Diameter  
= 3x Durchmesser

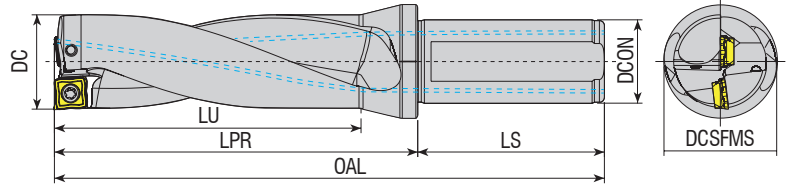

Takım Kodu  
Ordering Code  
Bestell-Bezeichnung

Stok  
Stock  
Lager

Takım Ölçüleri (mm)  
Dimension (mm)  
Abmessung (mm)

Maks. Ofset (radyal)  
Max. Offset (radial)  
Max. Versatz (radial)

Kesici Uç  
Insert  
Wendeschneidplatte

Yedek Parçaları / Spare Parts / Ersatzteile

Sıkma Vidası  
Screw  
Schraube

Tork Anahtar  
Torx Key  
Torx-Schlüssel

Takım Kodu Ordering Code Bestell-Bezeichnung	Stok Stock Lager	Takım Ölçüleri (mm) Dimension (mm) Abmessung (mm)							Maks. Ofset (radyal) Max. Offset (radial) Max. Versatz (radial)		Kesici Uç Insert Wendeschneidplatte	Sıkma Vidası Screw Schraube	Tork Anahtar Torx Key Torx-Schlüssel
		DC	DCON	DCSFMS	OAL	LU	LPR	LS	X <sub>max</sub> X <sub>max</sub> [mm]	DC <sub>max</sub> DC <sub>max</sub> [mm]			
ATUM 14XD3 SOMT 050204	●	14	20	25	114	42	64	50	0.5	15	SOMT 050204	3006-M2x4	82-T06
ATUM 14.5XD3 SOMT 050204	●	14.5	20	25	114	42	64	50	0.4	15.3			
ATUM 15XD3 SOMT 050204	●	15	20	25	117	45	67	50	0.4	15.8			
ATUM 15.5XD3 SOMT 050204	●	15.5	20	25	117	45	67	50	0.3	16.1			
ATUM 16XD3 SOMT 050204	●	16	25	34	126	48	70	56	0.3	16.6			
ATUM 16.5XD3 SOMT 060204	●	16.5	25	34	126	48	70	56	0.5	17.5			
ATUM 17XD3 SOMT 060204	●	17	25	34	129	51	73	56	0.5	18			
ATUM 17.5XD3 SOMT 060204	●	17.5	25	34	129	51	73	56	0.4	18.3			
ATUM 18XD3 SOMT 060204	●	18	25	34	132	54	76	56	0.4	18.8			
ATUM 18.5XD3 SOMT 060204	●	18.5	25	34	132	54	76	56	0.3	19.1			
ATUM 19XD3 SOMT 060204	●	19	25	34	135	57	79	56	0.3	19.6			
ATUM 19.5XD3 SOMT 070306	●	19.5	25	34	135	57	79	56	0.5	20.5			
ATUM 20XD3 SOMT 070306	●	20	25	34	138	60	82	56	0.5	21			
ATUM 20.5XD3 SOMT 070306	●	20.5	25	34	138	60	82	56	0.4	21.3			
ATUM 21XD3 SOMT 070306	●	21	25	34	141	63	85	56	0.4	21.8			
ATUM 22XD3 SOMT 070306	●	22	25	34	144	66	88	56	0.3	22.6			
ATUM 22.5XD3 SOMT 08T306	●	22.5	25	34	144	66	88	56	0.5	23.5			
ATUM 23XD3 SOMT 08T306	●	23	25	34	147	69	91	56	0.5	24			
ATUM 23.5XD3 SOMT 08T306	●	23.5	25	34	147	69	91	56	0.5	24.5			
ATUM 24XD3 SOMT 08T306	●	24	25	34	150	72	94	56	0.5	25			
ATUM 24.5XD3 SOMT 08T306	●	24.5	25	34	150	72	94	56	0.4	25.3			
ATUM 25XD3 SOMT 08T306	●	25	25	34	153	75	97	56	0.4	25.8			
ATUM 26XD3 SOMT 08T306	●	26	25	34	156	78	100	56	0.3	26.6			
ATUM 27XD3 SOMT 09T308	●	27	25	34	159	81	103	56	0.5	28			
ATUM 27.5XD3 SOMT 09T308	●	27.5	25	34	159	81	103	56	0.5	27.5			
ATUM 28XD3 SOMT 09T308	●	28	25	34	162	84	106	56	0.5	29			
ATUM 29XD3 SOMT 09T308	●	29	25	34	165	87	109	56	0.5	30			
ATUM 30XD3 SOMT 09T308	●	30	32	44	177	90	117	60	0.5	31			
ATUM 32XD3 SOMT 11T308	●	32	32	44	183	96	123	60	0.5	33			
ATUM 33XD3 SOMT 11T308	●	33	32	44	186	99	126	60	0.5	34			
ATUM 34XD3 SOMT 11T308	●	34	32	44	189	102	129	60	0.5	35			
ATUM 35XD3 SOMT 11T308	●	35	32	44	192	105	132	60	0.5	36			
ATUM 36XD3 SOMT 11T308	●	36	32	44	195	108	135	60	0.4	36.8			
ATUM 37XD3 SOMT 130408	●	37	32	44	198	111	138	60	0.5	38			
ATUM 38XD3 SOMT 130408	●	38	32	44	201	114	141	60	0.5	39			
ATUM 39XD3 SOMT 130408	●	39	32	44	204	117	144	60	0.5	40			
ATUM 40XD3 SOMT 130408	●	40	32	44	207	120	147	60	0.5	41			
ATUM 45XD3 SOMT 150510	●	45	40	54	237	135	167	70	0.5	46			
ATUM 49XD3 SOMT 150510	●	49	40	54	249	147	179	70	0.5	50			
ATUM 50XD3 SOMT 150510	●	50	40	54	252	150	182	70	0.5	51			

R: Sağ / Right / Rechts L: Sol / Left / Links

● Stokta / In Stock / Auf Lager ○ Stokta Yok / Non Stock Item / Kein Lagerartikel, Lieferzeit auf Anfrage  
TGTC Ucuna Uygun. / Compatible with TGTC Insert. / Kompatibel mit TGTC Wendeplatten.

Sipariş Örneği/Ordering Example/Bestellbeispiel

1 ad./pcs./stück ATUM 14XD3 SOMT 050204

Takma Uçlu Matkap Kullanım Kılavuzu : S 375 / User's Guide For U-Drills : P 375

Bedienungsanleitung für Vollbohrer : S 375



Delme Derinliği  
Drilling Depth  
Bohrtiefe  
= 4x Çap  
= 4x Diameter  
= 4x Durchmesser

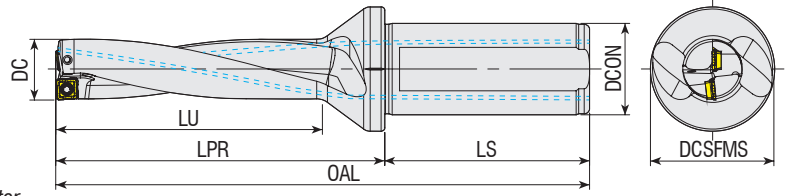

Takım Kodu Ordering Code Bestell-Bezeichnung	Stok Stock Lager	Takım Ölçüleri (mm) Dimension (mm) Abmessung (mm)							Maks. Ofset (radyal) Max. Offset (radial) Max. Versatz (radial)	Kesici Uç Insert Wendeschneidplatte	Yedek Parçaları / Spare Parts / Ersatzteile		
		DC	DCON	DCSFMS	OAL	LU	LPR	LS			Sıkma Vidası Screw Schraube	Tork Anahtar Torx Key Torx-Schlüssel	
ATUM 14XD4 SOMT 050204	●	14	20	25	128	56	78	50	0.5	15	SOMT 050204	3006-M2x4	82-T06
ATUM 14.5XD4 SOMT 050204	●	14.5	20	25	128	56	78	50	0.4	15.3			
ATUM 16XD4 SOMT 050204	●	16	25	34	142	64	86	56	0.3	16.6			
ATUM 17XD4 SOMT 060204	●	17	25	34	146	68	90	56	0.5	18			
ATUM 17.5XD4 SOMT 060204	●	17.5	25	34	146	68	90	56	0.4	18.3	SOMT 060204	3007-M2.2x4.6	82-T07
ATUM 18XD4 SOMT 060204	●	18	25	34	150	72	94	56	0.4	18.8			
ATUM 19XD4 SOMT 060204	●	19	25	34	154	76	98	56	0.3	19.6			
ATUM 20XD4 SOMT 070306	●	20	25	34	158	80	102	56	0.5	21	SOMT 070306		
ATUM 21XD4 SOMT 070306	●	21	25	34	162	84	106	56	0.4	21.8			
ATUM 22XD4 SOMT 070306	●	22	25	34	166	88	110	56	0.3	22.6	SOMT 08T306	3008-M2.5x6	82-T08
ATUM 24XD4 SOMT 08T306	●	24	25	34	174	96	118	56	0.5	25			
ATUM 25XD4 SOMT 08T306	●	25	25	34	178	100	122	56	0.4	25.8			

R: Sağ / Right / Rechts/ L: Sol / Left / Links  
● Stokta / In Stock / Auf Lager ○ Stokta Yok / Non Stock Item / Kein Lagerartikel, Lieferzeit auf Anfrage  
TGTC Ucuına Uyğundur. / Compatible with TGTC Insert. / Kompatibel mit TGTC Wendeplatten.

Sipariş Örneği/Ordering Example/Bestellbeispiel  
1 ad./pcs./stück ATUM 14XD4 SOMT 050204  
Takma Uçlu Matkap Kullanım Kılavuzu : S 375 / User's Guide For U-Drills : P 375  
Bedienungsanleitung für Vollbohrer : S 375





Delme Derinliği  
Drilling Depth  
Bohrtiefe

= 5x Çap  
= 5x Diameter  
= 5x Durchmesser

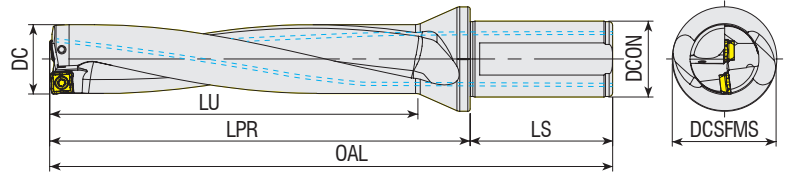

**Takım Kodu**  
**Ordering Code**  
**Bestell-Bezeichnung**

Stok Stock Lager	Takım Ölçüleri (mm) Dimension (mm) Abmessung (mm)								Maks. Ofset (radyal) Max. Offset (radial) Max. Versatz (radial)		Kesici Uç Insert Wendeschneidplatte	Yedek Parçaları / Spare Parts / Ersatzteile	
	DC	DCON	DCSFMS	OAL	LU	LPR	LS	$X_{max}$	$DC_{max}$	Sıkma Vidası Screw Schraube		Tork Anahtar Torx Key Torx-Schlüssel	
ATUM 14XD5 SOMT 050204	●	14	20	25	142	70	92	50	0.5	15	SOMT 050204	3006-M2x4	82-T06
ATUM 15XD5 SOMT 050204	●	15	20	25	147	75	97	50	0.4	15.8			
ATUM 15.5XD5 SOMT 050204	●	15.5	20	25	147	75	97	50	0.3	16.1			
ATUM 16XD5 SOMT 050204	●	16	25	34	158	80	102	56	0.3	16.6			
ATUM 16.5XD5 SOMT 060204	●	16.5	25	34	158	80	102	56	0.5	17.5	SOMT 060204	3007-M2.2x4.6	82-T07
ATUM 17.5XD5 SOMT 060204	●	17.5	25	34	163	85	107	56	0.4	18.3			
ATUM 18XD5 SOMT 060204	●	18	25	34	168	90	112	56	0.4	18.8			
ATUM 18.5XD5 SOMT 060204	●	18.5	25	34	168	90	112	56	0.3	19.1			
ATUM 19XD5 SOMT 060204	●	19	25	34	173	95	117	56	0.3	19.6	SOMT 070306	3008-M2.5x6	82-T08
ATUM 19.5XD5 SOMT 070306	●	19.5	25	34	173	95	117	56	0.5	20.5			
ATUM 20XD5 SOMT 070306	●	20	25	34	178	100	122	56	0.5	21			
ATUM 21XD5 SOMT 070306	●	21	25	34	183	105	127	56	0.4	21.8			
ATUM 22XD5 SOMT 070306	●	22	25	34	188	110	132	56	0.3	22.6	SOMT 08T306	3008-M2.5x6	82-T08
ATUM 23XD5 SOMT 08T306	●	23	25	34	193	115	137	56	0.5	24			
ATUM 24XD5 SOMT 08T306	●	24	25	34	198	120	142	56	0.5	25			
ATUM 25XD5 SOMT 08T306	●	25	25	34	203	125	147	56	0.4	25.8			
ATUM 26XD5 SOMT 08T306	●	26	25	34	208	130	152	56	0.3	26.6	SOMT 09T308	4015-M3.5x9	80-T15
ATUM 27XD5 SOMT 09T308	●	27	25	34	213	135	157	56	0.5	28			
ATUM 28XD5 SOMT 09T308	●	28	25	34	218	140	162	56	0.5	29			
ATUM 29XD5 SOMT 09T308	●	29	25	34	223	145	167	56	0.5	30			
ATUM 30XD5 SOMT 09T308	●	30	32	44	237	150	177	60	0.5	31	SOMT 11T308	4015-M3.5x9	80-T15
ATUM 33XD5 SOMT 11T308	●	33	32	44	252	165	192	60	0.5	34			
ATUM 34XD5 SOMT 11T308	●	34	32	44	257	170	197	60	0.5	35			
ATUM 35XD5 SOMT 11T308	●	35	32	44	262	175	202	60	0.5	36			
ATUM 36XD5 SOMT 11T308	●	36	32	44	267	180	207	60	0.4	36.8			

R: Sağ / Right / Rechts L: Sol / Left / Links

● Stokta / In Stock / Auf Lager ○ Stokta Yok / Non Stock Item / Kein Lagerartikel, Lieferzeit auf Anfrage

TGTC Ucuna Uygun. / Compatible with TGTC Insert. / Kompatibel mit TGTC Wendeplatten.

Sipariş Örneği/Ordering Example/Bestellbeispiel

1 ad./pcs./stück ATUM 14XD5 SOMT 050204

Takma Uçlu Matkap Kullanım Kılavuzu : S 375 / User's Guide For U-Drills : P 375

Bedienungsanleitung für Vollbohrer : S 375



Delme Derinliği = 3x Çap  
Drilling Depth = 3x Diameter  
Bohrtiefe = 3x Durchmesser

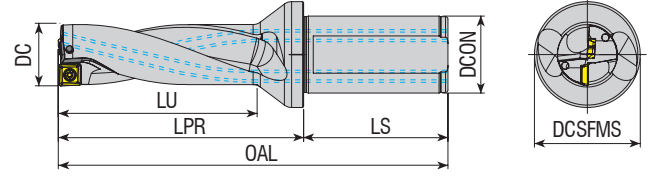

Takım Kodu Ordering Code Bestell-Bezeichnung	Stok Stock Lager	Takım Ölçüleri (mm) Dimension (mm) Abmessung (mm)								Maks. Ofset (radyal) Max. Offset (radial) Max. Versatz (radial)		Kesici Uç Insert Wendeschneidplatte	Sıkma Vidası Screw Schraube	Tork Anahtar Torx Key Torx-Schlüssel
		DC	DCON	DCSFMS	OAL	LU	LPR	LS	X <sub>max</sub>	DC <sub>max</sub>				
ATUM 14XD3 880-0202..	●	14	20	25	108	42	58	50	0.5	15	880-02...C/P	3006-M2x4	82-T06	
ATUM 14.5XD3 880-0202..	●	14.5	20	25	110	46	60	50	0.45	15.4				
ATUM 15XD3 880-0202..	●	15	20	25	112	48	62	50	0.4	15.8				
ATUM 15.5XD3 880-0202..	●	15.5	20	25	114	50	64	50	0.3	16.1				
ATUM 16XD3 880-0202..	●	16	20	25	116	51	66	50	0.3	16.6				
ATUM 16.5XD3 880-0303..	●	16.5	20	25	118	53	68	50	0.6	17.7	880-03...C/P	3007-M2.2x4.6	82-T07	
ATUM 17XD3 880-0303..	●	17	20	25	119	54	69	50	0.6	18.2				
ATUM 17.5XD3 880-0303..	●	17.5	25	32	128	56	72	56	0.5	18.5				
ATUM 18XD3 880-0303..	●	18	25	32	129	57	73	56	0.4	18.8				
ATUM 18.5XD3 880-0303..	●	18.5	25	32	131	59	75	56	0.4	19.3				
ATUM 19XD3 880-0303..	●	19	25	32	132	60	76	56	0.3	19.6				
ATUM 19.5XD3 880-0303..	●	19.5	25	32	135	62	79	56	0.3	20.1				
ATUM 20XD3 880-0403..	●	20	25	32	137	64	81	56	0.9	21.8				
ATUM 20.5XD3 880-0403..	●	20.5	25	32	138	65	82	56	0.8	22.1				
ATUM 21XD3 880-0403..	●	21	25	32	140	66	84	56	0.8	22.6	880-04...C/P	3008-M2.5x6	82-T08	
ATUM 21.5XD3 880-0403..	●	21.5	25	32	142	68	86	56	0.7	22.9				
ATUM 22XD3 880-0403..	●	22	25	32	143	69	87	56	0.6	23.2				
ATUM 22.5XD3 880-0403..	●	22.5	25	32	146	71	90	56	0.5	23.5				
ATUM 23XD3 880-0403..	●	23	25	32	147	72	91	56	0.5	24				
ATUM 23.5XD3 880-0403..	●	23.5	25	34	149	69	93	56	0.4	24.3				
ATUM 24XD3 880-0503..	●	24	25	32	151	76	95	56	1.1	26.2				880-05...C/P
ATUM 25XD3 880-0503..	●	25	25	32	155	79	99	56	1	27				
ATUM 26XD3 880-0503..	●	26	32	44	162	81	102	60	0.9	27.8				
ATUM 27XD3 880-0503..	●	27	32	44	165	84	105	60	0.7	28.4				
ATUM 28XD3 880-0503..	●	28	32	44	169	87	109	60	0.6	29.2				
ATUM 29XD3 880-0503..	●	29	32	44	172	90	112	60	0.5	30				
ATUM 30XD3 880-0604..	●	30	32	44	177	94	117	60	1.1	32.2	880-06...C/P	3010-M3.5x9	82-T10	
ATUM 31XD3 880-0604..	●	31	40	54	191	97	121	70	1	33				
ATUM 32XD3 880-0604..	●	32	40	54	194	100	124	70	0.9	33.8				
ATUM 33XD3 880-0604..	●	33	40	54	198	103	128	70	0.7	34.4				
ATUM 34XD3 880-0604..	●	34	40	54	201	106	131	70	0.5	35				
ATUM 35XD3 880-0604..	●	35	40	54	205	109	135	70	0.4	35.8				
ATUM 36XD3 880-0704..	●	36	40	54	209	112	139	70	1.3	38.6				880-07...C/P
ATUM 38XD3 880-0704..	●	38	40	54	216	118	146	70	1.1	40.2				
ATUM 39XD3 880-0704..	●	39	40	54	219	121	149	70	1	41				
ATUM 40XD3 880-0704..	●	40	40	54	223	124	153	70	0.8	41.6				
ATUM 41XD3 880-0704..	●	41	40	54	227	127	157	70	0.7	42.4				
ATUM 42XD3 880-0704..	●	42	40	54	230	130	160	70	0.6	43.2				
ATUM 45XD3 880-0805..	●	45	40	54	242	140	172	70	1.4	47.8	880-08...C/P	4015-M4x11	80-T15	
ATUM 46XD3 880-0805..	●	46	40	54	246	143	176	70	1.3	48.6				
ATUM 48XD3 880-0805..	●	48	40	54	253	149	183	70	1	50				
ATUM 50XD3 880-0805..	●	50	40	54	260	155	190	70	0.8	51.6				

R: Sağ / Right / Rechts/ L: Sol / Left / Links

● Stokta / In Stock / Auf Lager ○ Stokta Yok / Non Stock Item / Kein Lagerartikel, Lieferzeit auf Anfrage

SNDVK Ucuna Uygundur. / Compatible with SNDVK Insert. / Kompatibel mit SNDVK Wendeplatten.

Sipariş Örneği/Ordering Example/Bestellbeispiel

1 ad./pcs./stück ATUM 14XD3 880-0202..

Takma Uçlu Matkap Kullanım Kılavuzu : S 375 / User's Guide For U-Drills : P 375

Bedienungsanleitung für Vollbohrer : S 375



# HELİSEL İÇTEN SU VERME KANALLI MATKAPLAR

## INDEXABLE DRILLS WITH HELICAL COOLANT HOLE

Farklı çaplarda ve ALFA KAPLAMA teknolojisi ile siparişe hazır.

**They are ready to order in different diameters and with ALPHA COATING technology.**

- Helisel içten su verme kanallı • **Helical Internal Coolant Holes**
- Üstün Alpha Kaplama Teknolojisi • **Superior Alpha Coating Technology**
- 1000 Vickers'e dayanan yüksek yüzey sertliği • **High surface hardness up to 1000 Vickers**
- Aşınmaya karşı yüksek direnç • **High resistance to abrasion**
- Dengeli ve hassas kesim • **Balanced and precise cutting**

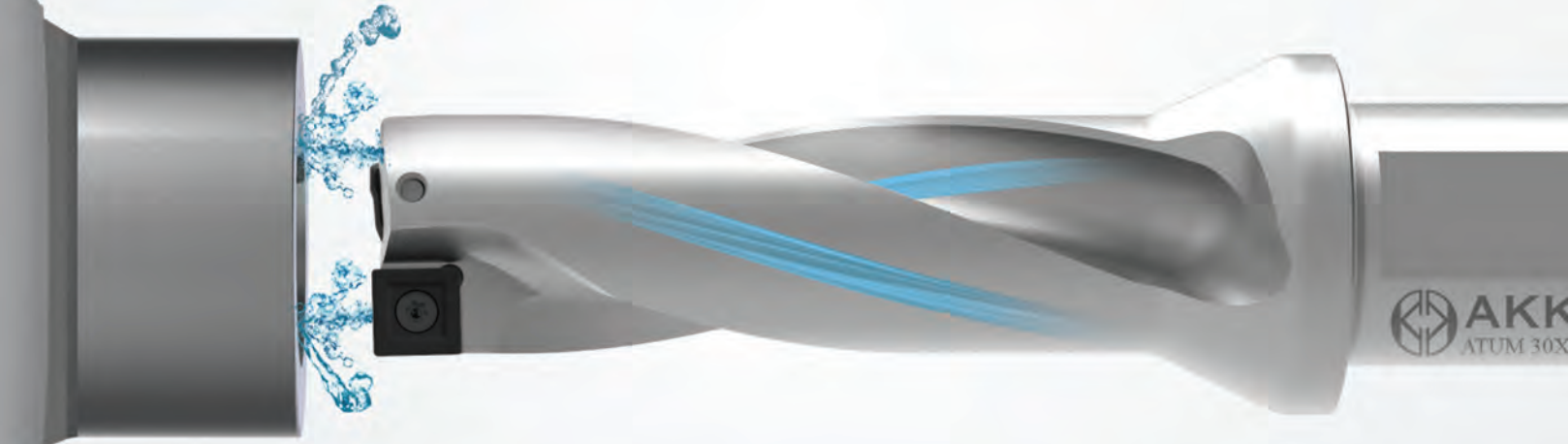

AKKO HELİSEL KANAL TEKNOLOJİSİ  
AKKO HELICAL CHANNEL TECHNOLOGY

RAKİPLER  
COMPETITORS

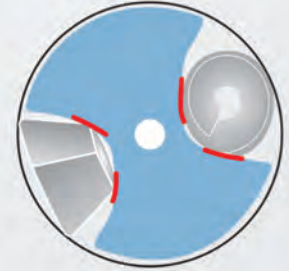

\* STOK DURUMU / STOCK STATUS

**D2 / D3 / D4 / D5**

\* Helisel İçten Su Verme Kanalı  
Twisted Coolant Hole

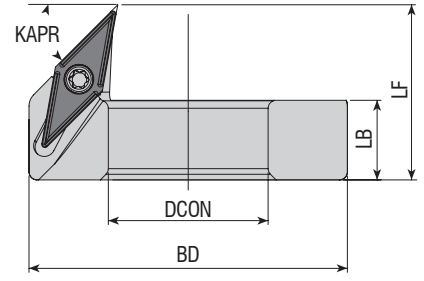

Takım Kodu Ordering Code Bestell-Bezeichnung	Stok Stock Lager	Takım Ölçüleri (mm) Dimension (mm) Abmessung (mm)				Kullanılacak ATUM Ölçüsü Compatible ATUM Diameter Kompatibler Vollbohrer	Yedek Parçaları / Spare Parts / Ersatzteile				
		BD	DCON	LB	LF		ATUM Ø	Kesici Uç Insert Wendeschneidplatte	Sıkma Vidası Screw Schraube	Tork Anahtar Torx Key Torx-Schlüssel	Montaj Vidası Mounting Screw Befestigungsschraube
ADCR-120-VB1103	●	32	12	10	22	12.5	VB.T 1103..	4008-M2.5x6	82-T08	AAV-14-M5x14	AAL-03-3
ADCR-125-VB1103	●	32.5	12.5	10	22	13					
ADCR-130-VB1103	●	33	13	10	22	13.5					
ADCR-135-VB1103	●	33.5	13.5	10	22	14					
ADCR-140-VB1103	●	34	14	10	22	14.5					
ADCR-145-VB1103	●	34.5	14.5	10	22	15					
ADCR-150-VB1103	●	35	15	10	22	15.5 - 16					
ADCR-155-VB1103	●	35.5	15.5	10	22	16.5					
ADCR-160-VB1103	●	36	16	10	22	17					
ADCR-165-VB1103	●	36.5	16.5	10	22	17.5					
ADCR-170-VB1103	●	37	17	10	22	18					
ADCR-175-VB1103	●	37.5	17.5	10	22	18.5					
ADCR-180-VB1103	●	38	18	10	22	19					
ADCR-185-VB1103	●	38.5	18.5	10	22	19.5					
ADCR-190-VB1103	●	39	19	10	22	20					
ADCR-195-VB1103	●	39.5	19.5	10	22	20.5					
ADCR-200-VB1103	●	40	20	10	22	21					
ADCR-205-VB1103	●	40.5	20.5	10	22	21.5					
ADCR-210-VB1103	●	41	21	10	22	22					
ADCR-215-VB1103	●	41.5	21.5	10	22	22.5					
ADCR-220-VB1103	●	42	22	10	22	23					
ADCR-225-VB1103	●	42.5	22.5	10	22	23.5					
ADCR-230-VB1103	●	43	23	10	22	24					
ADCR-235-VB1103	●	43.5	23.5	10	22	24.5					
ADCR-240-VB1103	●	44	24	10	22	25					
ADCR-245-VB1103	●	44.5	24.5	10	22	25.5					
ADCR-250-VB1103	●	45	25	10	22	26					
ADCR-255-VB1103	●	45.5	25.5	10	22	26.5					
ADCR-260-VB1103	●	46	26	10	22	27					
ADCR-265-VB1103	●	46.5	26.5	10	22	27.5					
ADCR-270-VB1103	●	47	27	10	22	28					
ADCR-275-VB1103	●	47.5	27.5	10	22	28.5					
ADCR-280-VB1103	●	48	28	10	22	29					
ADCR-285-VB1103	●	48.5	28.5	10	22	29.5					
ADCR-290-VB1103	●	49	29	10	22	30					
ADCR-295-VB1103	●	49.5	29.5	10	22	30.5					
ADCR-300-VB1103	●	50	30	10	22	31					

R: Sağ / Right / Rechts / L: Sol / Left / Links

● Stokta / In Stock / Auf Lager ○ Stokta Yok / Non Stock Item / Kein Lagerartikel, Lieferzeit auf Anfrage  
ISO Ucuna Uygundur. / Compatible with ISO Insert. / Kompatibel mit ISO Wendeplatten.

Sipariş Örneği/Ordering Example/Bestellbeispiel

1 ad./pcs./stück ADCR-120-VB1103

Delik Pahlama Bileziği Kullanım Kılavuzu : S 219 / User's Guide For Drill Chamfering Ring Tools : P 219

Technische Information Für Bohrer-Fasringwerkzeuge: P 219

Tavsiye Edilen / Recommended / Empfehlung

A

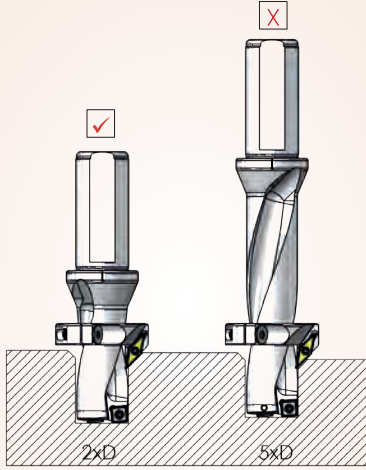

Mümkünse, her zaman kısa bir delme takımı kullanın. Değilse, titreşimi en aza indirmek için kesme hızını azaltın.  
If possible, use it always short drilling tools. Otherwise, reduce your speeds to minimize vibration.  
Bitte möglichst kurze Bohrwerkzeuge verwenden. Sollte dies nicht möglich sein, reduzieren Sie bitte die Geschwindigkeit, um Vibrationen zu vermeiden.

B

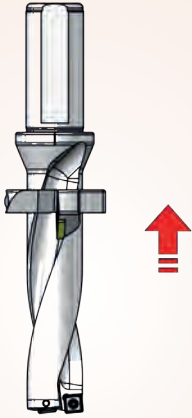

Mümkün olduğunca pah kırma halkasını shaft kısmına yakın montaj yap.  
Get close to the mounting shaft of the chamfering ring as possible.  
Befestigen Sie den Fasing möglichst nah am Schaft.

C

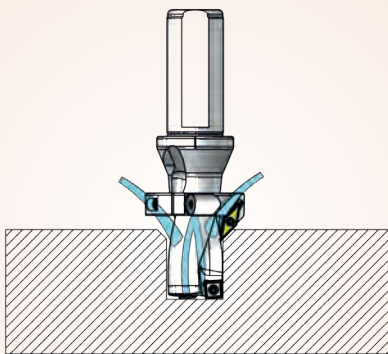

Daha iyi uç ömrü için harici soğutucu ve matkap ucu iç soğutucu uygulamak.  
Apply external cooling and internal coolant drill for a better life for inserts.  
Setzen Sie innere und äußere Kühlung ein, um die Standzeit der Wendepaltten zu erhöhen.

Montaj Şekli / Mounting System / Montage-Hinweise

1



Matkap gövdesi üzerine pah kırma halkasını takın.  
Put the chamfering ring to drill body.  
Schieben Sie den Fasing auf den Bohrkörper.

2

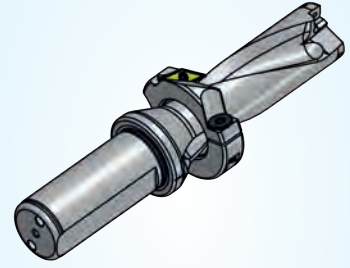

İstenilen konuma pah kırma halkasını kaydırın.  
Please slide chamfering ring to the desired position.  
Befestigen Sie den Fasing an der gewünschten Position.

3

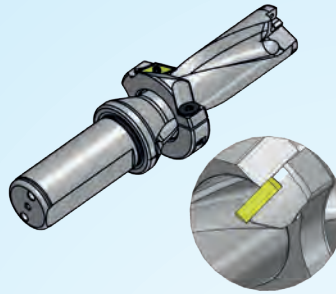

Pah kırma halkasını talaş akışına mani olmayacak şekilde helis başlangıcına denk getirin.  
Please keep chamfering ring position which will not resist to fluiding chips and try to be equal to the helix start points.  
Positionieren Sie den Fasing bündig mit der Bohrspirale um einen problemlosen Späne-transport zu gewährleisten.

4

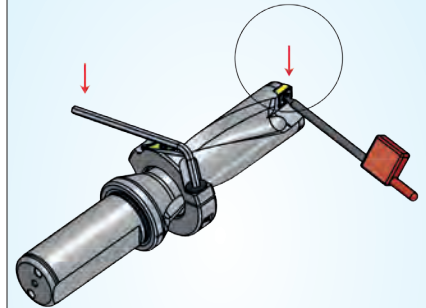

Pah kırma halkasını sıkın ve matkabin uçlarını takın.  
Tightening the chamfering ring and put the drill insert.  
Den Fasing festziehen und die Bohr-Wendepaltten einbauen.

Pah kırma halkasının doğru montaj şekli.  
Proper installation of chamfering rings.  
Korrekte Montage des Fasrings.

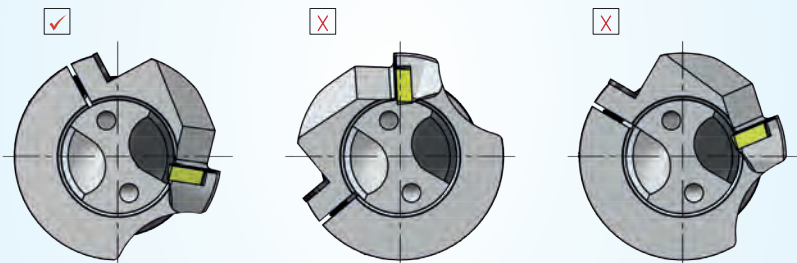

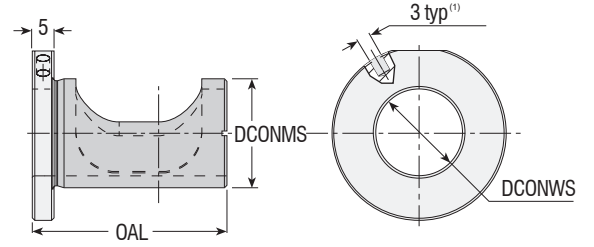

Takım Kodu Ordering Code Bestell-Bezeichnung	Stok Stock Lager	Takım Ölçüleri (mm) Dimension (mm) Abmessung (mm)		
		DCON	BD	LF
AET-2025	●	20	25	44
AET-2532	●	25	32	46
AET-3240	●	32	40	55

■ <sup>(1)</sup>Delik ince bir metal yardımıyla adaptörün radyal olarak ayarlanmasını kolaylaştırmak için kullanılır. / Holes for inserting a pin, used to facilitate radial adjustment of the sleeve (pin not supplied).  
 Bohrung zum Einsetzen eines Stiftes mit dem der Adapter radial eingestellt werden kann (Stift ist nicht im Lieferumfang enthalten).

Frezeleme tezgahında takma uçlu matkabın nominal çapı, matkabın ekseninin, spindle eksenine göre ötelenmesiyle değiştirilebilir.  
 On a milling machine the drill's nominal diameter can be changed by shifting the drill's axis out of the tool spindle.

Auf einer Fräsmaschine kann die Nennweite des Bohrers durch Verschieben der Bohrerachse aus der Spindelachse verändert werden.

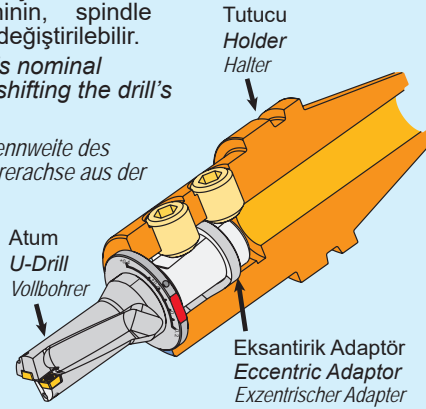

Radyal ayarlama pimi.  
(Verilmeyecektir.)  
 Radial adjustment pin. (not supplied)  
 Radial - Einstellstift  
(nicht im Lieferumfang)

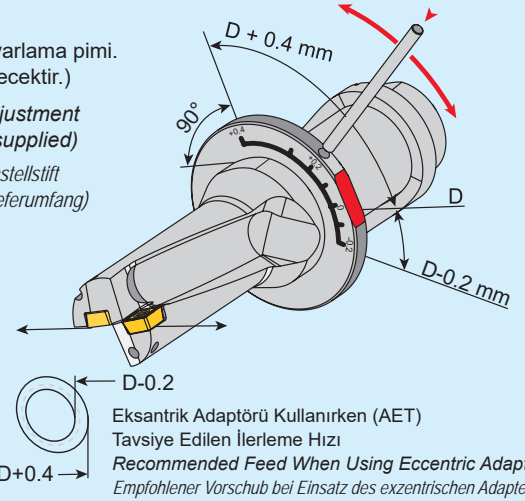

Eksantrik Adaptörü Kullanırken (AET)  
 Tavsiye Edilen İlerleme Hızı  
 Recommended Feed When Using Eccentric Adaptor  
 Empfohlener Vorschub bei Einsatz des exzentrischen Adapters

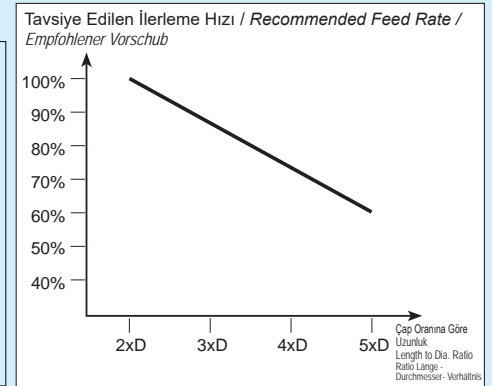
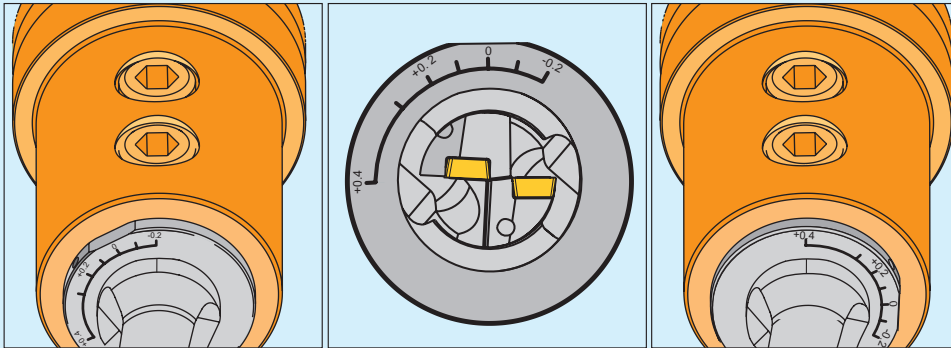

Delik Çapı  
24.8 mm  
Hole Diameter  
Lochdurchmesser

U-Drill Çapı = 25 mm  
Drill Diameter = 25 mm  
Vollbohrer Durchmesser = 25mm

Delik Çapı  
25 mm  
Hole Diameter  
Lochdurchmesser

U-Drill Çapı = 25 mm  
Drill Diameter = 25 mm  
Vollbohrer Durchmesser = 25mm

Delik Çapı  
25.4 mm  
Hole Diameter  
Lochdurchmesser

U-Drill Çapı = 25 mm  
Drill Diameter = 25 mm  
Vollbohrer Durchmesser = 25mm

ATUM'un üzerindeki düz çizgi adaptörün sıfır rakamının üzerine konulmalıdır. AET'nin (eksantrik adaptörün) çevrilmesini kolaylaştırmak için AET'nin üzerindeki deliğe, metal bir çubuk ya da vida anahtarları yerleştirilebilir. AET'yi ayarlama öncesi tutucunun vidasını hafifçe çözün.

The adjustment markings should be located perpendicular to the flat on the circumference of the U-DRILL flange. To facilitate the rotation of the adaptor, a metal rod or a screw key may be inserted into a hole on the eccentric adaptor flange. Unlock adapter screw before adjusting adaptor.

Die Einstellmarkierung sollte senkrecht zur Fläche des Bohrerschaftes stehen. Zum Drehen des Adapters sollte ein Stift in die Bohrung am Adapterflansch eingesetzt werden. Lösen Sie die Adapter-Schraube vor dem Einstellen des Adapters.

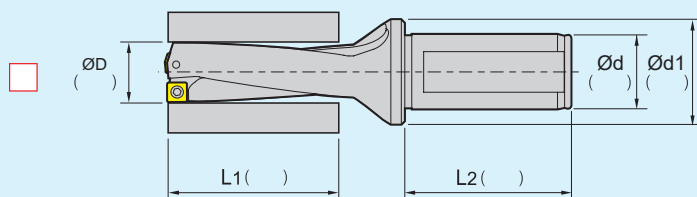
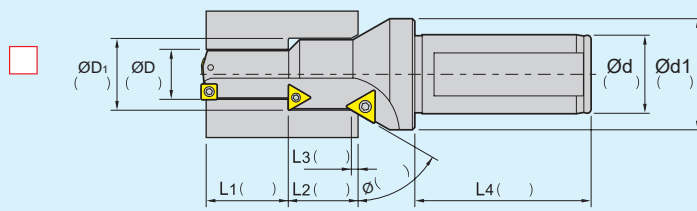
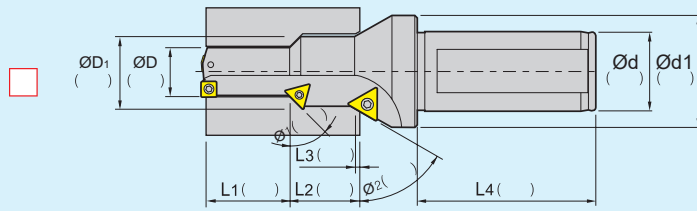
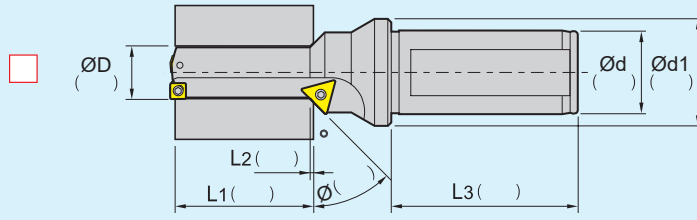
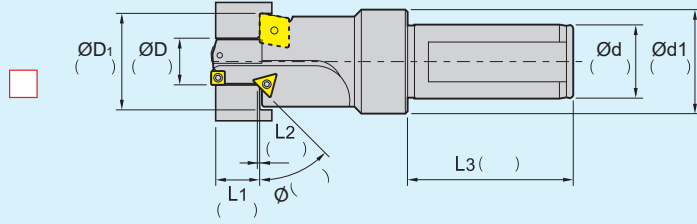

• Soğutma Tipi / Coolant type / Kühlmittelanschluss

- Yağ Deliği Dalma Kismında  
Oil Hole On the Plunge Part  
Kühlmittelzuführung über den Bund
- Yağ Deliği Şaft Kismında  
"Oil hole On the Shank"  
Kühlmittelbohrung durch den Schaft

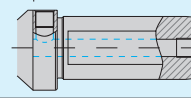

• Delik Tipi / Hole Type / Bohrungstyp

- Kapalı Delik  
Blind Hole  
Grundbohrung
- Açık Delik  
Thru Hole  
Durchgangsbohrung

• Şaft Tipleri / Types of Shank / Schaftausführung

- Düz Tip  
Flat Type  
Bohrungstyp
- Weldon Tip  
Weldon Type  
Weldon-Schaft
- Eğimli Yargı Tipi  
Whistle Notch Type  
Whistle-Notch-Schaft

• Yargı Bağlama Yeri / Location of Side Lock / Position der Spannfläche

- Dış Uca Parellel (Standart)  
Parallel to Peripheral Insert (Standard)  
Parallel zur äußeren Wendeplatte
- Dış Uca 90° Açılı  
90° angle to peripheral insert  
90° außen abgewinkelt
- Dış Uca 150° Açılı  
150° angle to peripheral insert  
150° außen abgewinkelt
- Dış Uca 180° Açılı  
180° angle to peripheral insert  
180° außen abgewinkelt

• Not / Note / Hinweis :

- Şu Anki Kullanılan Takım / Currently Using Tool
- Aktuell verwendetes Werkzeug
- Şu Anki Kesme Durumu / Current Cutting Condition
- Aktuelle Schnittbedingungen
- RPM ya da vc(m/min) / - RPM or vc(m/min)
- Umdrehungen pro Minute oder vc (m/min.)
- vf(mm/min) ya da fn(mm/rev)
- vf(mm/min) or fn(mm/rev) or fn (mm/Umdr.)
- Kesme Derinliği / Depth of Cut(mm)
- Schnitttiefe (mm)
- Ölçülen Standart Takım Ömrü / Standard of Measuring Tool Life
- Standzeit des Werkzeugs
- Şu Anki Kullanılan Makinalar / Currently Using Machine
- Aktuell eingesetzte Maschine
- İşleme Merkezi / Machining Center
- Bearbeitungszentrum
- Genel Torna / General Lathe
- Drehmaschine
- CNC Torna / CNC Lathe
- CNC-Drehmaschine



*konusulan  
the spoken kalite...  
quality...*

# EKONOMİK KESİCİLER

**EKONOMİK KESİCİLER**

MULTI FUNCTIONAL CUTTING TOOLS

MULTIFUNKTIONALES DREH- UND BOHRWERKZEUG





AKKO **A** **EK** **R** - **D2.25** x **20**

**X** **C** ■ ■ **10** **T3** **04**

**2** Kesiş Stili / Cutter Style / Werkzeugtyp  
EK : Ekonomik Kesici / Economic Cutting  
Multifunktionales Dreh- und Bohrwerkzeug

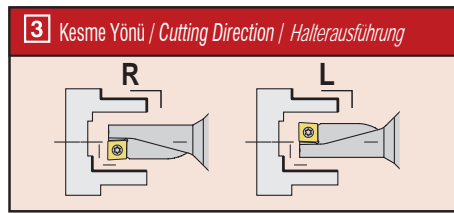

**11** Kalınlık / Thickness / Dicke

01 s = 1.59  
T1 s = 1.98  
02 s = 2.38  
T2 s = 2.78  
03 s = 3.18  
T3 s = 3.97  
04 s = 4.76  
05 s = 5.56  
06 s = 6.35  
07 s = 7.94  
09 s = 9.52

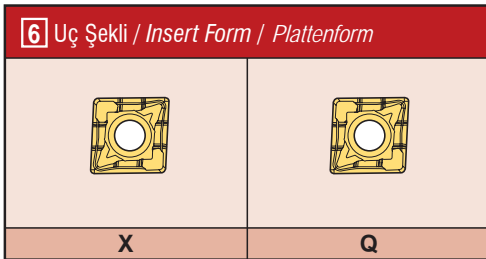
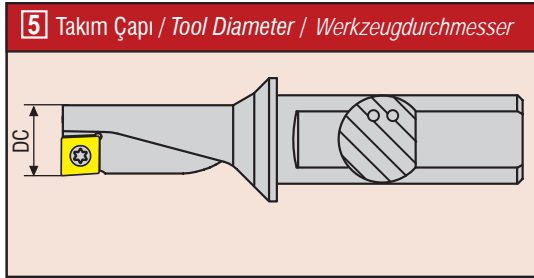
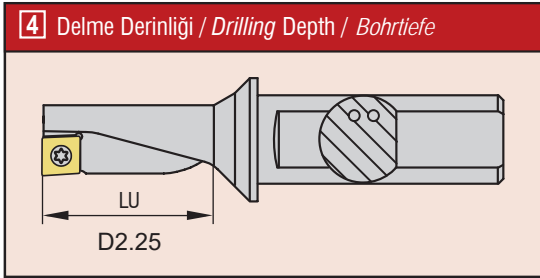

**8** Toleranslar / Tolerance Classes / Toleranzen

	IC	M	S
A	± 0.025	± 0.005	± 0.025
C	± 0.025	± 0.013	± 0.025
E	± 0.025	± 0.025	± 0.025
F	± 0.013	± 0.005	± 0.025
G	± 0.025	± 0.025	± 0.130
H	± 0.013	± 0.013	± 0.025
J	± 0.05-0.15	± 0.005	± 0.025
K	± 0.05-0.15	± 0.013	± 0.025
L	± 0.05-0.15	± 0.025	± 0.025
M	± 0.05-0.15	± 0.08-0.20	± 0.130
N	± 0.05-0.15	± 0.08-0.20	± 0.025
U	± 0.08-0.25	± 0.13-0.38	± 0.130

IC : Daire Ölçüsü / Inscribed Circle  
M : Şekle Göre / Refer to Figure  
S : Kalınlık / Thickness

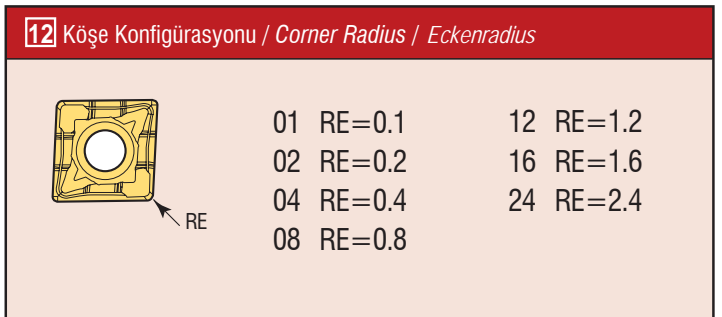
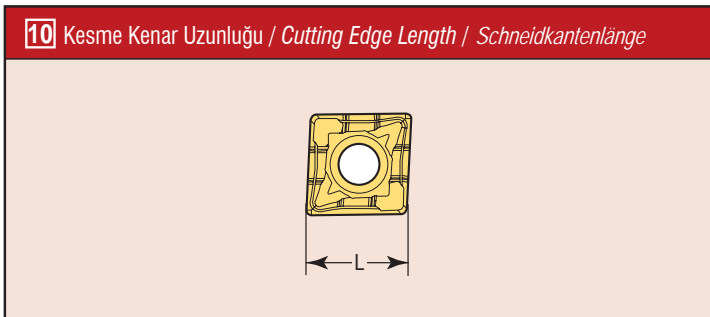
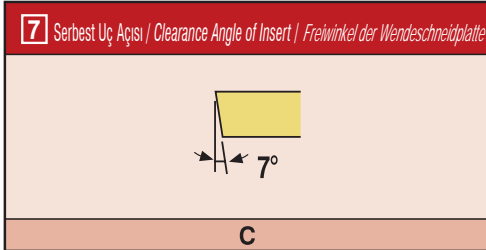
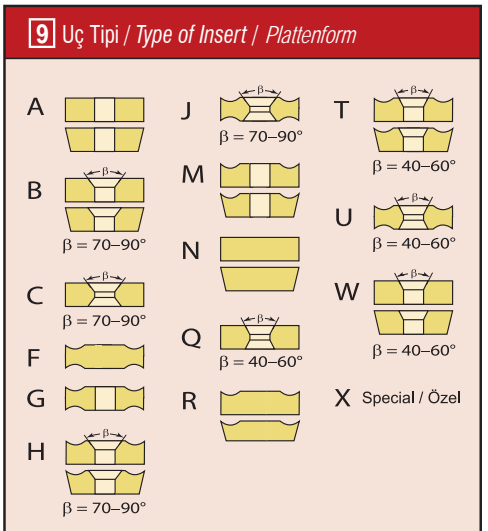

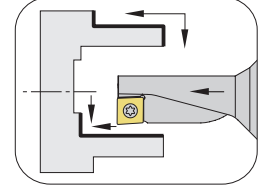
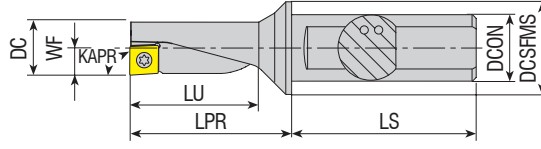

Takım Kodu Ordering Code Bestell-Bezeichnung	Stok Stock Lager		Takım Ölçüleri (mm) Dimension (mm) Abmessung (mm)							Kesici Uç Insert Wendeschneidplatte	Yedek Parçaları / Spare Parts / Ersatzteile	
	R	L	DC	DCON	DCSFMS	LU	LPR	LS	WF	Sıkma Vidası Screw Schraube	Tork Anahtar Torx Key Torx-Schlüssel	
AEKR/L-D2.25X8 XC.. 040104	●	●	8	10	12	18	22	38	4	<b>XC.. 040104</b>	3006-M1.8x4	82-T06
AEKR/L-D2.25X10 XC.. 050204	●	●	10	12	16	22.5	27.5	42	5	<b>XC.. 050204</b>	3006-M2x4	82-T07
AEKR/L-D2.25X12 XC.. 060204	●	●	12	16	20	27	33	45	6	<b>XC.. 060204</b>	3007-M2.2x4.6	82-T08
AEKR/L-D2.25X14 XC.. 070304	●	●	14	16	20	31.5	38	45	7	<b>XC.. 070304</b>	3008-M2.5x6	82-T08
AEKR/L-D2.25X16 XC.. 080304	●	●	16	20	25	36	44	50	8	<b>XC.. 080304</b>	3008-M3x6	80-T15
AEKR/L-D2.25X18 XC.. 09T304	●	●	18	25	32	40.5	53.5	56	9	<b>XC.. 09T304</b>	4015-M3.5x9	80-T20
AEKR/L-D2.25X20 XC.. 10T304	●	●	20	25	32	45	55	56	10	<b>XC.. 10T304</b>	4020-M4.5x10	80-T20
AEKR/L-D2.25X25 XC.. 130404	●	●	25	32	40	56.5	69	60	12.5	<b>XC.. 130404</b>	4020-M4.5x12	
AEKR/L-D2.25X32 XC.. 170504	●	●	32	32	50	72	88	60	16	<b>XC.. 170504</b>		

R: Sağ / Right / Rechts / L: Sol / Left / Links  
 ● Stokta / In Stock / Auf Lager ○ Stokta Yok / Non Stock Item / Kein Lagerartikel, Lieferzeit auf Anfrage  
 CRTZT-ISCR-TGTC-KRLY Ucuna Uygunudur. / Compatible with CRTZT-ISCR-TGTC-KRLY Insert.  
 Kompatibel mit CRTZT-ISCR-TGTC-KRLY

Sipariş Örneği/Ordering Example/Bestellbeispiel  
 1 ad./pcs./stück AEKR-D2.25X8 XC.. 040104

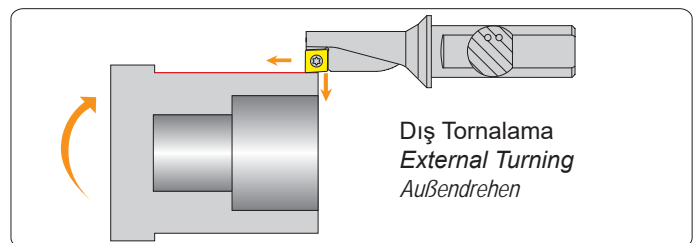
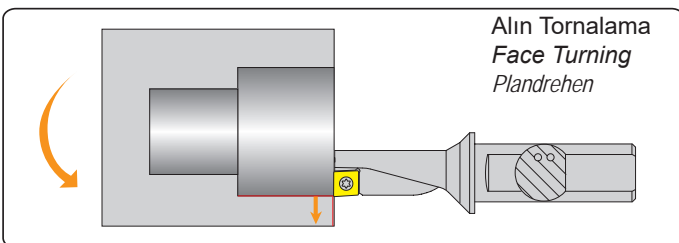
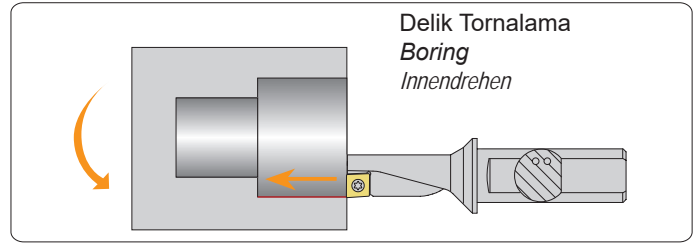
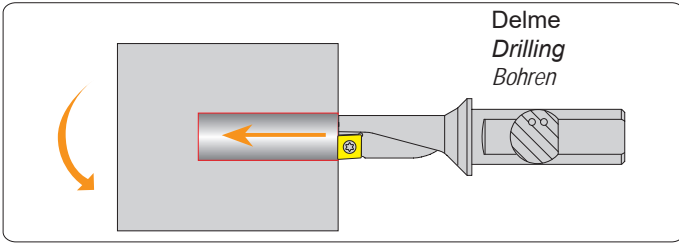
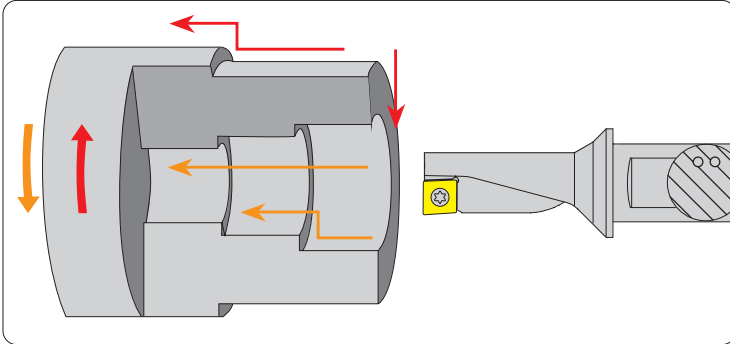



# BARALAR

AYARLI DELİK İŞLEME BARALARI  
ADJUSTABLE BORING HEADS  
EINSTELLBARE SPINDELKÖPFE

*konusulan  
the spoken kalite...  
quality...*

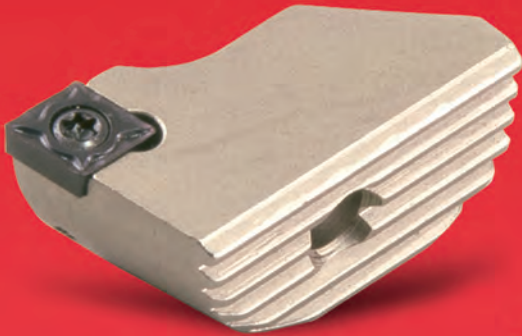

AKKO **A** **BH** **R** - **D18x22**

**W16** - **L90** - **CC06**

**2** Kesiş Stili / Cutter Style / Werkzeugtyp

BH : Delik İşleme / Boring Head  
Spindelkopf

**3** İşlem Tipi / Cutter Type / Einsatzgebiet

R : Kaba Baralama / Rough Boring  
Schruppbearbeitung  
F : Hassas Baralama / Fine Boring  
Schlichtbearbeitung

**5** Montaj Formu / Assembly Form / Schaftform

W : Weldon

**4** Ölçü Aralığı / Boring Range / Bohrbereich

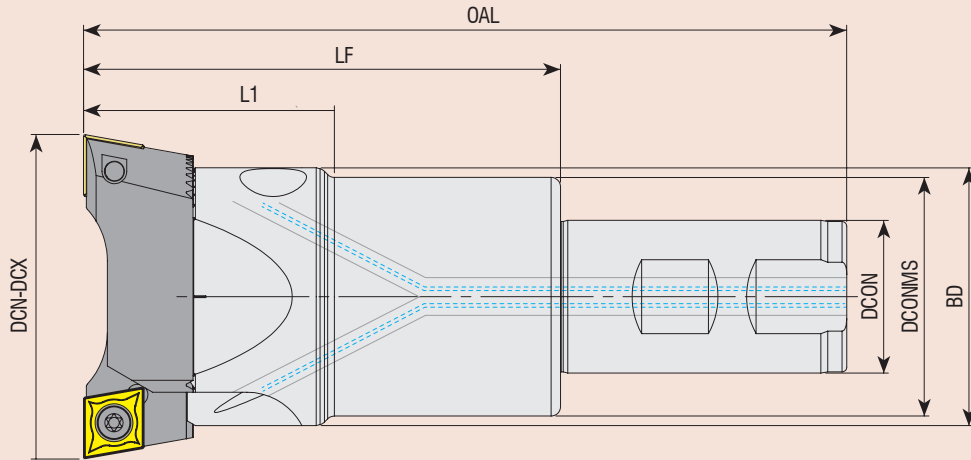

**6** Takım Boyu / Tool Length / Werkzeuglänge

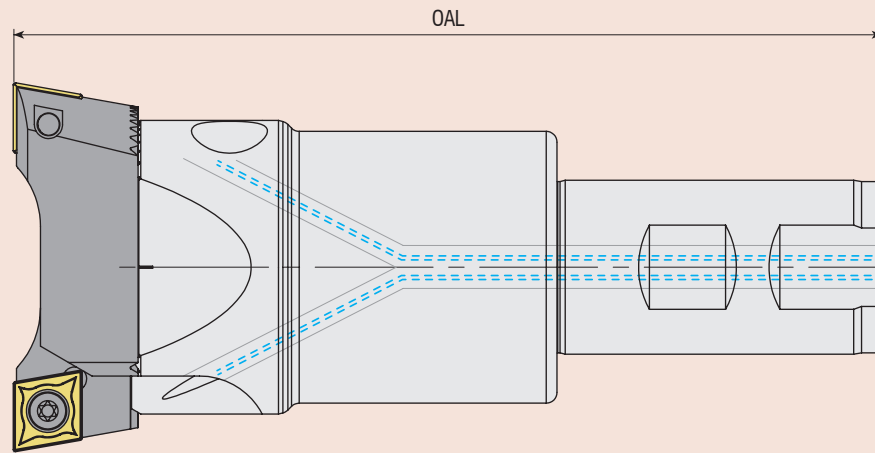

**7** Kesici Uç / Insert / Wendeschneidplatte

CC06 : CC.. 0602..  
CC09 : CC.. 09T3..  
CC12 : CC.. 1204..

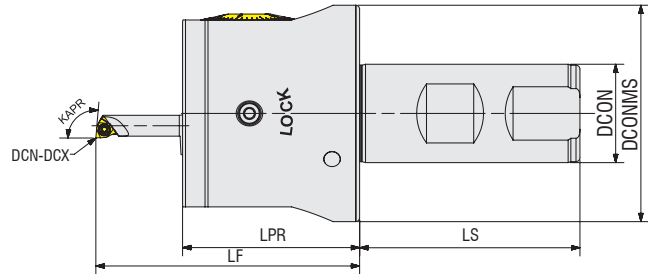

Takım Kodu Ordering Code Bestell-Bezeichnung	Stok Stock Lager	Ölçü Aralığı Boring Range Bohrbereich DCN-DCX	Takım Ölçüleri (mm) Dimension (mm) Abmessung (mm)							Kartuş Cartridge Kurzdrehalter	Kesici Uç Insert Wendeschneidplatte	Bara Gövde Takım Kodu Boring Head Body Code Trägerwerkzeug-Bezeichnung			
			LF	LPR	LS	DCON	DCONMS	KAPR	DCN				DCX		
SET-06X30-ABHF-D06X30-WA25	●	06-30	67	45	56	25	55	95°	6	10	SWLCR-D06X10-22	WCGT020104L	ABHF-D06X30-WA25		
			75						8	14	SWLCR-D08X14-30				
			85						12	18	STUPR-D12X18-40				
			93°						16	22	STUPR-D16X22-40				
			20						26	STUPR-D20X26-40					
SET-29X40-ABHF-D29X40-WA16	●	29-40	50	46	40	16	27	93°	29	35	STFPR-D29x35	TPGX 090202L	ABHF-D29X40-WA16		
			34						40	STFPR-D34x40					
SET-39X54-ABHF-D39X54-WA20	●	39-54	60	55	50	20	36	93°	39	47	STFPR-D39x47			TPGX 090202L	ABHF-D39X54-WA20
			46						54	STFPR-D46x54					
SET-52X80-ABHF-D52X80-WA25	●	52-80	70	65	56	25	48	93°	52	68	STFPR-D52x68				
			64						80	STFPR-D64x80					
SET-78X116-ABHF-D78X170-WA32	●	78-116	83	77	60	32	70	93°	78	98	STFPR-D78x98	TPGX 090202L	ABHF-D78X170-WA32		
			96						116	STFPR-D96x116					

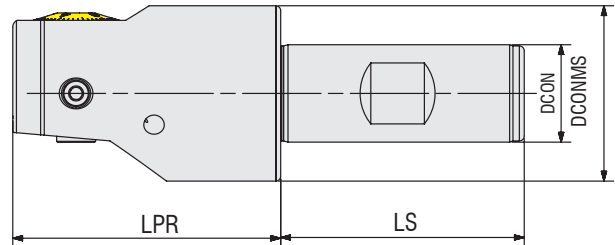

Takım Kodu Ordering Code Bestell-Bezeichnung	Stok Stock Lager	Ölçü Aralığı Boring Range Bohrbereich DCN-DCX	LPR	LS	DCON	DCONMS	Yedek Parçaları / Spare Parts / Ersatzteile	
							Anahtar Allen Key Innensechskantschlüssel	Anahtar Allen Key Innensechskantschlüssel
ABHF-D06X30-WA25	●	06-30	45	56	25	55	AAL-05-4	
ABHF-D29X40-WA16	●	29-40	46	40	16	27	AAL-01-2	AAL-02-2.5
ABHF-D39X54-WA20	●	39-54	55	50	20	36	AAL-02-2.5	AAL-03-3
ABHF-D52X80-WA25	●	52-80	65	56	25	48	AAL-05-4	AAL-07-5
ABHF-D78X170-WA32	●	78-170	77	60	32	72	AAL-07-5	AAL-08-6

R: Sağ / Right / Rechts/ L: Sol / Left / Links

● Stokta / In Stock / Auf Lager ○ Stokta Yok / Non Stock Item / Kein Lagerartikel, Lieferzeit auf Anfrage

Siparişte, gövde ve kartuş set olarak verilecektir. / When ordered, body and cartridge will be sent as set.

Bei Bestellung werden Körper und Kassetten als Set geliefert.

Sipariş Örneği/Ordering Example/Bestellbeispiel

1 ad./pcs./stück SET-06X30-ABHF-D06X30-WA25

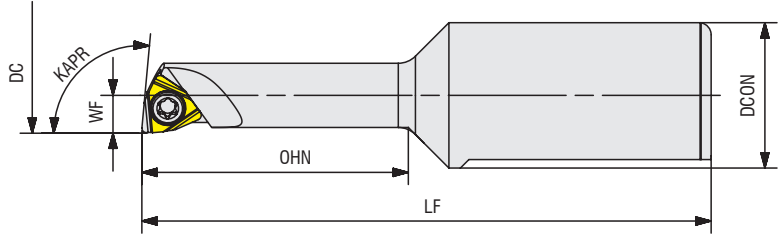

Takım Kodu Ordering Code Bestell-Bezeichnung	Stok Stock Lager	Takım Ölçüleri (mm) Dimension (mm) Abmessung (mm)						Kesici Uç Insert Wendeschneidplatte	Yedek Parçaları / Spare Parts / Ersatzteile	
		DCN	WF	KAPR	LF	OHN	DCON		Sıkma Vidası Screw Schraube	Tork Anahtar Torx Key Torx-Schlüssel
SWLCR-D06X10-22	●	6	3	95°	47	22	12	WCGT020104L	3006-M2x3.3	82-T06
SWLCR-D08X14-30	●	8	4		55	30				

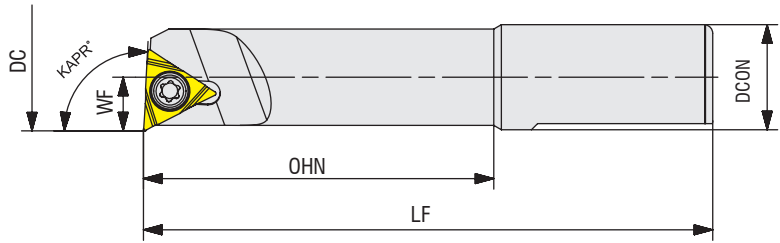

Takım Kodu Ordering Code Bestell-Bezeichnung	Stok Stock Lager	Takım Ölçüleri (mm) Dimension (mm) Abmessung (mm)						Kesici Uç Insert Wendeschneidplatte	Yedek Parçaları / Spare Parts / Ersatzteile				
		DCN	WF	KAPR	LF	OHN	DCON		Sıkma Vidası Screw Schraube	Tork Anahtar Torx Key Torx-Schlüssel			
STUPR-D12X18-40	●	12	6	93°	65	40	12	TPGX 090202L	4008-M2.5x4.5	82-T08			
STUPR-D16X22-40	●	16	8										
STUPR-D20X26-40	●	20	10										
STUPR-D24X30-50	●	24	12								75	50	

● Stokta / In Stock / Auf Lager ○ Stokta Yok / Non Stock Item / Kein Lagerartikel, Lieferzeit auf Anfrage  
Siparişte, gövde ve kartuş set olarak verilecektir. / When ordered, body and cartridge will be sent as set.  
Bei Bestellung werden Körper und Kassetten als Set geliefert.

Sipariş Örneği/Ordering Example/Bestellbeispiel  
1 ad./pcs./stück SWLCR-D06X10-22

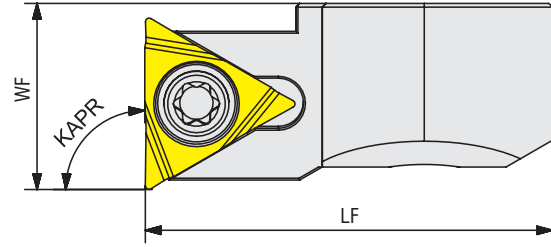
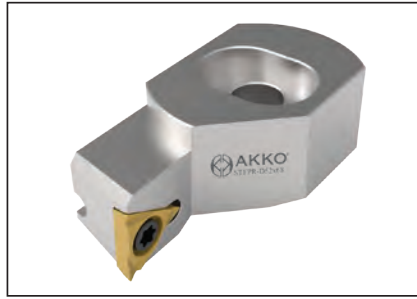

Takım Kodu Ordering Code Bestell-Bezeichnung	Stok Stock Lager	Takım Ölçüleri (mm) Dimension (mm) Abmessung (mm)			Kesici Uç Insert Wendeschneidplatte	Yedek Parçaları / Spare Parts / Ersatzteile	
		WF	KAPR	LF		Sıkma Vidası Screw Schraube	Tork Anahtar Torx Key Torx-Schlüssel
STFPR-D29x35	●	10	90°	21.90	TPGX_090202L	4008-M2.5x6	82-T08
STFPR-D34x40	●	12.50		21.90			
STFPR-D39x47	●	12		26.90			
STFPR-D46x54	●	15.50		26.90			
STFPR-D52x68	●	14		34.90			
STFPR-D64x80	●	20		34.90			
STFPR-D78x98	●	20		44.90			
STFPR-D96x116	●	29		44.90			

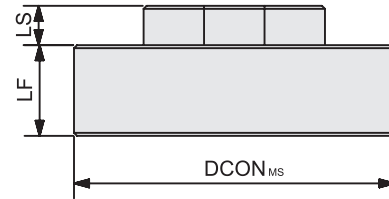
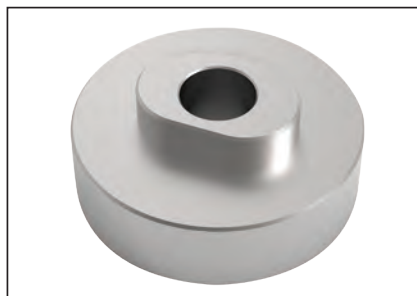

Takım Kodu Ordering Code Bestell-Bezeichnung	Stok Stock Lager	Takım Ölçüleri (mm) Dimension (mm) Abmessung (mm)		
		DCON	LF	LS
AEA-114x134	●	31.80	12.90	9
AEA-132x152	●	31.80	21.90	18

● Stokta / In Stock / Auf Lager ○ Stokta Yok / Non Stock Item / Kein Lagerartikel, Lieferzeit auf Anfrage  
Siparişte, gövde ve kartuş set olarak verilecektir. / When ordered, body and cartridge will be sent as set.  
Bei Bestellung werden Körper und Kassetten als Set geliefert.

Sipariş Örneği/Ordering Example/Bestellbeispiel  
1 ad./pcs./stück STFPR-D29x35

Kartuşların Montajı / Assembling Boring Bar / Kartuschen Montage

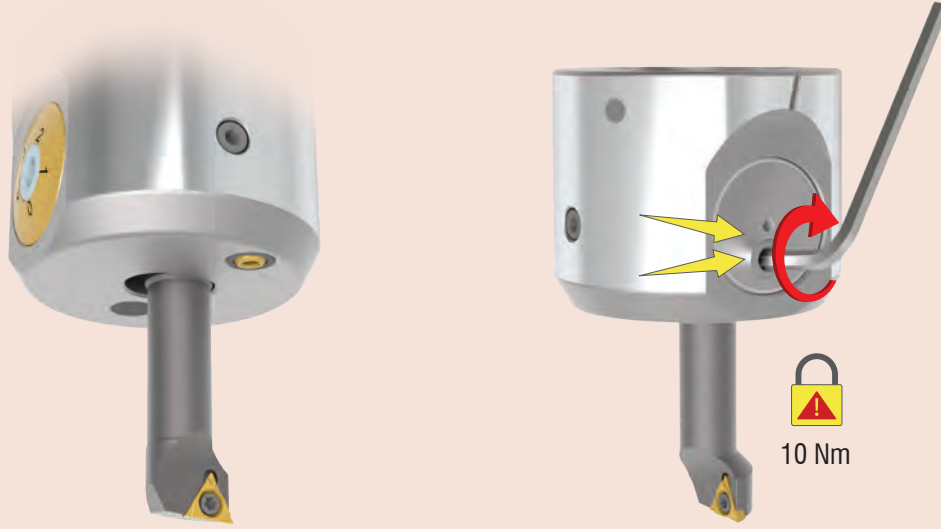

Çap Ayarı / Diameter Adjustment / Umfangeinstellung

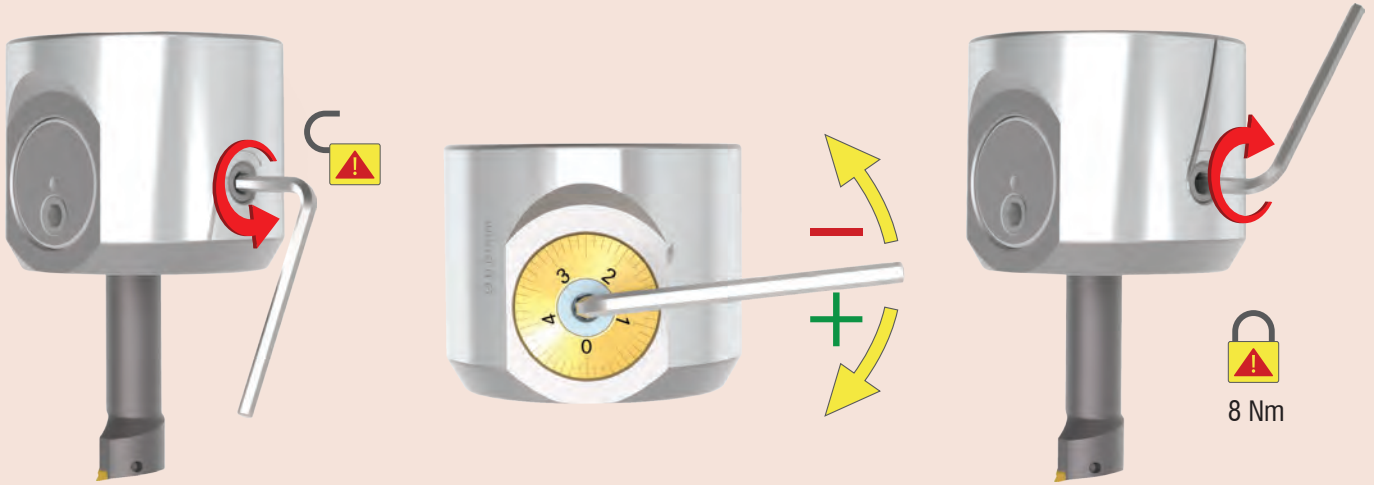

Ölçek / Scale - Vernier / Messparat

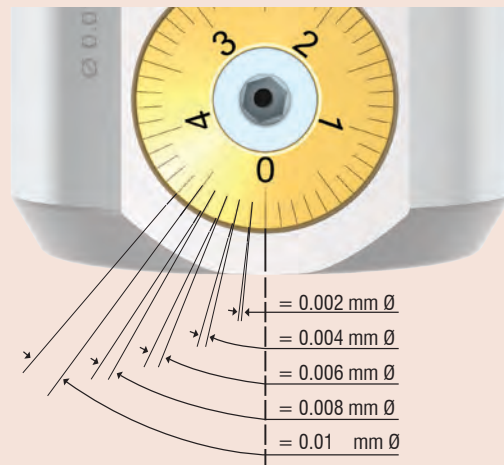
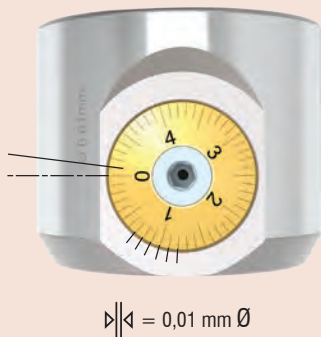

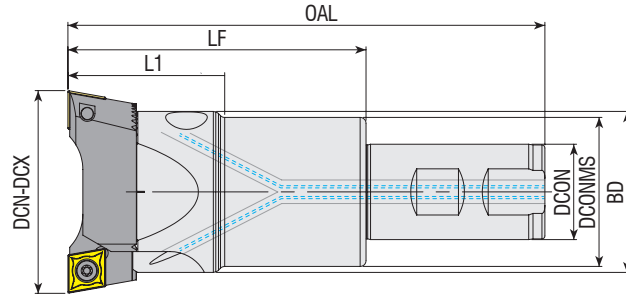

DIN 1835

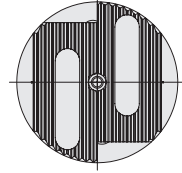

**Takım Kodu**  
**Ordering Code**  
**Bestell-Bezeichnung**

Stok  
Stock  
Lager

Takım Ölçüleri (mm)  
Dimension (mm)  
Abmessung (mm)

Kartuş  
Cartridge  
Kurzdrehhalter

Bara Gövde Takım Kodu  
Boring Head Body Code  
Trägerwerkzeug-Bezeichnung

	Ölçü Aralığı Boring Range Durchmesser DCN-DCX	DCON	DCONMS	BD	OAL	LF	L1		
ABHR-D18x22-W16-L90-CC06	● 18-22	16	-	-	90	42	-	AK.. 18-22	ABHRS-D16x42-W16-L90
ABHR-D18x22-W16-L150-CC06	● 18-22	16	-	-	150	102	-		ABHRS-D16x102-W16-L150
ABHR-D18x22-W16-L200-CC06	● 18-22	16	-	-	200	152	-		ABHRS-D16x152-W16-L200
ABHR-D22x28-W20-L100-CC06	● 22-28	20	-	-	100	50	-	AK.. 22-28	ABHRS-D20x50-W20-L100
ABHR-D22x28-W20-L150-CC06	● 22-28	20	-	-	150	100	-		ABHRS-D20x100-W20-L150
ABHR-D22x28-W20-L200-CC06	● 22-28	20	-	-	200	150	-		ABHRS-D20x150-W20-L200
ABHR-D28x38-W20-L110-CC06	● 28-38	20	25	-	110	60	-	AK.. 28-38	ABHRS-D25x60-W20-L110
ABHR-D28x38-W20-L160-CC06	● 28-38	20	25	-	160	110	-		ABHRS-D25x110-W20-L160
ABHR-D28x38-W20-L230-CC06	● 28-38	20	25	-	230	180	-		ABHRS-D25x180-W20-L230
ABHR-D36x50-W25-L120-CC06	● 36-50	25	32	-	120	64	-	AK.. 36-50	ABHRS-D32x64-W25-L120
ABHR-D36x50-W25-L170-CC06	● 36-50	25	32	-	170	114	-		ABHRS-D32x114-W25-L170
ABHR-D36x50-W25-L250-CC06	● 36-50	25	32	-	250	194	-		ABHRS-D32x194-W25-L250
ABHR-D36x50-W25-L120-CC09	● 36-50	25	32	-	120	64	-	AK.. 36-50-09	ABHRS-D32x64-W25-L120
ABHR-D36x50-W25-L170-CC09	● 36-50	25	32	-	170	114	-		ABHRS-D32x114-W25-L170
ABHR-D36x50-W25-L250-CC09	● 36-50	25	32	-	250	194	-		ABHRS-D32x194-W25-L250
ABHR-D50x68-W32-L140-CC09	● 50-68	32	40	-	140	80	-	AK.. 50-68	ABHRS-D40x80-W32-L140
ABHR-D50x68-W32-L200-CC09	● 50-68	32	40	-	200	140	-		ABHRS-D40x140-W32-L200
ABHR-D50x68-W32-L280-CC09	● 50-68	32	40	-	280	220	-		ABHRS-D40x220-W32-L280
ABHR-D50x68-W32-L140-CC12	● 50-68	32	40	-	140	80	-	AK.. 50-68-12	ABHRS-D40x80-W32-L140
ABHR-D50x68-W32-L200-CC12	● 50-68	32	40	-	200	140	-		ABHRS-D40x140-W32-L200
ABHR-D50x68-W32-L280-CC12	● 50-68	32	40	-	280	220	-		ABHRS-D40x220-W32-L280
ABHR-D68x90-W32-L160-CC12	● 68-90	32	50	54	160	100	50	AK.. 68-90	ABHRS-D50x100-W32-L160
ABHR-D68x90-W32-L210-CC12	● 68-90	32	50	54	210	150	50		ABHRS-D50x150-W32-L210
ABHR-D68x90-W32-L280-CC12	● 68-90	32	50	54	280	220	50		ABHRS-D50x220-W32-L280
ABHR-D90x120-W32-L140-CC12	● 90-120	32	63	72	140	80	63	AK.. 90-120	ABHRS-D63x80-W32-L140
ABHR-D90x120-W40-L200-CC12	● 90-120	40	63	72	200	130	63		ABHRS-D63x130-W40-L200
ABHR-D90x120-W40-L300-CC12	● 90-120	40	63	72	300	230	63		ABHRS-D63x230-W40-L300
ABHR-D120x160-W40-L210-CC12	● 120-160	40	80	95	210	140	75	AK.. 120-160	ABHRS-D80x140-W40-L210
ABHR-D120x160-W40-L300-CC12	● 120-160	40	80	95	300	230	75		ABHRS-D80x230-W40-L300
ABHR-D160x200-W40-L210-B-CC12	● 160-200	40	80	95	210	140	75	AK.. 160-800	ABHRS-D80x140-W40-L210
ABHR-D160x200-W40-L300-B-CC12	● 160-200	40	80	95	300	230	75		ABHRS-D80x230-W40-L300

R: Sağ / Right / Rechtsl L: Sol / Left / Links

● Stokta / In Stock / Auf Lager ○ Stokta Yok / Non Stock Item / Kein Lagerartikel, Lieferzeit auf Anfrage  
Siparişte, gövde ve kartuş set olarak verilecektir. / When ordered, body and cartridge will be sent as set.  
Bei Bestellung werden Körper und Kassetten als Set geliefert.

Sipariş Örneği/Ordering Example/Bestellbeispiel  
1 ad./pcs./stück ABHR-D18x22-W16-L90-CC06

AYARLI KABA DELİK İŞLEME BARA GÖVDESİ  
ADJUSTABLE ROUGH BORING HEADS BODY

TRÄGERWERKZEUGE FÜR EINSTELLBARE SCHRUPP-SPINDELKÖPFE

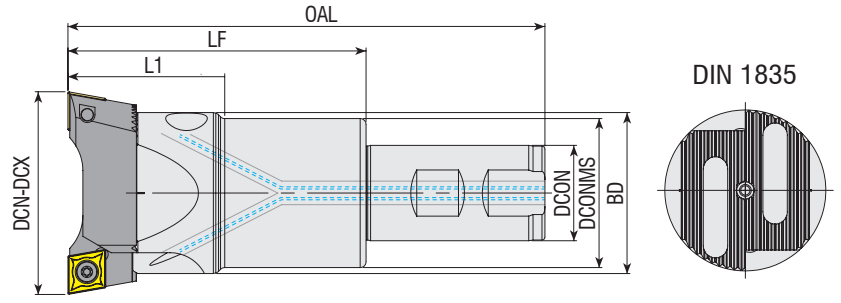

**Takım Kodu**  
**Ordering Code**  
**Bestell-Bezeichnung**

Stok  
Stock  
Lager

Ölçü Aralığı  
Boring Range  
Durchmesser  
DCN-DCX

Takım Ölçüleri (mm)  
Dimension (mm)  
Abmessung (mm)

Yedek Parçaları / Spare Parts / Ersatzteile

Montaj Vidası  
Mounting Screw  
Befestigungsschraube

Montaj Vida Anahtarı  
Mounting Screw Key  
Innenschlüssel für Bolzen

Pabuç  
Clamp  
Spannspratze

Ayar Vidası  
Adjusting Screw  
Einstellschraube

Ayar Vida Anahtarı  
Allen Key  
Innenschlüssel

Takım Kodu Ordering Code Bestell-Bezeichnung	Stok Stock Lager	Ölçü Aralığı Boring Range Durchmesser DCN-DCX	DCON	DCONMS	BD	OAL	LF	L1	Yedek Parçaları / Spare Parts / Ersatzteile				
									Montaj Vidası Mounting Screw Befestigungsschraube	Montaj Vida Anahtarı Mounting Screw Key Innenschlüssel für Bolzen	Pabuç Clamp Spannspratze	Ayar Vidası Adjusting Screw Einstellschraube	Ayar Vida Anahtarı Allen Key Innenschlüssel
ABHRS-D16x42-W16-L90	●	18-22	16	-	-	90	42	-	2525-M3x14	AAL-02-2.5	ABKS-D16	2715-M3x4	
ABHRS-D16x102-W16-L150	●	18-22	16	-	-	150	102	-					
ABHRS-D16x152-W16-L200	●	18-22	16	-	-	200	152	-					
ABHRS-D20x50-W20-L100	●	22-28	20	-	-	100	50	-					
ABHRS-D20x100-W20-L150	●	22-28	20	-	-	150	100	-	2503-M4x15	AAL-03-3	ABKS-D20	2715-M3x5	AAL-09-1.5
ABHRS-D20x150-W20-L200	●	22-28	20	-	-	200	150	-					
ABHRS-D25x60-W20-L110	●	28-38	20	25	-	110	60	-					
ABHRS-D25x110-W20-L160	●	28-38	20	25	-	160	110	-	2503-M4x20	AAL-03-3	ABKS-D25	2715-M3x8	
ABHRS-D25x180-W20-L230	●	28-38	20	25	-	230	180	-					
ABHRS-D32X64-W25-L120	●	36-50	25	32	-	120	64	-					
ABHRS-D32X114-W25-L170	●	36-50	25	32	-	170	114	-	2504-M5x25	AAL-05-4	ABKS-D32	2702-M4x12	AAL-01-2
ABHRS-D32X194-W25-L250	●	36-50	25	32	-	250	194	-					
ABHRS-D40x80-W32-L140	●	50-68	32	40	-	140	80	-					
ABHRS-D40x140-W32-L200	●	50-68	32	40	-	200	140	-	2505-M6x30	AAL-07-5	ABKS-D40	2725-M5x16	
ABHRS-D40x220-W32-L280	●	50-68	32	40	-	280	220	-					AAL-02-2.5
ABHRS-D50x100-W32-L160	●	68-90	32	50	54	160	100	50					
ABHRS-D50x150-W32-L210	●	68-90	32	50	54	210	150	50	2506-M8x35	AAL-08-6	ABKS-D50	2725-M5x12	
ABHRS-D50x220-W32-L280	●	68-90	32	50	54	280	220	50					
ABHRS-D63x80-W32-L140	●	90-120	32	63	72	140	80	63					
ABHRS-D63x130-W40-L200	●	90-120	40	63	72	200	130	63	2508-M10x40	AAL-11-8	ABKS-D63	2703-M6x16	AAL-03-3
ABHRS-D63x230-W40-L300	●	90-120	40	63	72	300	230	63					
ABHRS-D80x140-W40-L210	●	120-160	40	80	95	210	140	75	2510-M12x40				
ABHRS-D80x230-W40-L300	●	120-160	40	80	95	300	230	75					
ABHRS-D80x140-W40-L210	●	160-200	40	80	95	210	140	75					
ABHRS-D80x230-W40-L300	●	160-200	40	80	95	300	230	75					

R: Sağ / Right / Rechts/ L: Sol / Left / Links

● Stokta / In Stock / Auf Lager ○ Stokta Yok / Non Stock Item / Kein Lagerartikel, Lieferzeit auf Anfrage

Sipariş Örneği/Ordering Example/Bestellbeispiel

1 ad./pcs./stück ABHRS-D16x42-W16-L90



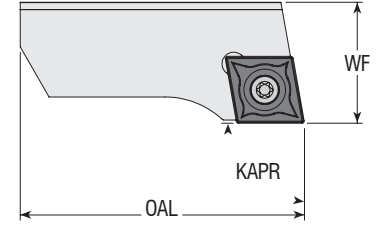

Takım Kodu Ordering Code Bestell-Bezeichnung	Stok Stock Lager	Takım Ölçüleri (mm) Dimension (mm) Abmessung (mm)			Kesici Uç Insert Wendeschneidplatte	Yedek Parçaları / Spare Parts / Ersatzteile		
		Ölçü Aralığı Boring Range	WF	OAL		Sıkma Vidası Screw Schraube	Tork Anahtar Torx Key Torx-Schlüssel	
AKSR 18-22	●	18-22	9	15	CC.T 0602..	4008-M2.5x6	82-T08	
AKSR 22-28	●	22-28	10	19				
AKSR 28-38	●	28-38	13	23				
AKSR 36-50	●	36-50	16	32	CC.T 09T3..	4015-M3.5x8	80-T15	
AKSR 36-50-09	●	36-50	16	32				
AKSR 50-68	●	50-68	20	40				
AKSR 50-68-12	●	50-68	20	40	CC.T 1204..	1020-M5x11	80-T20	
AKSR 68-90	●	68-90	23	54				
AKSR 90-120	●	90-120	28	70				
AKSR 120-160	●	120-160	32	95				
AKSR 160-200	●	160-200	32	120				

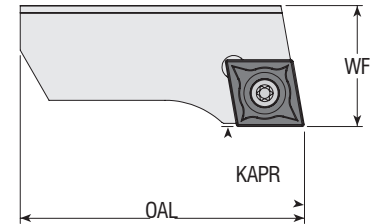

Takım Kodu Ordering Code Bestell-Bezeichnung	Stok Stock Lager	Takım Ölçüleri (mm) Dimension (mm) Abmessung (mm)			Kesici Uç Insert Wendeschneidplatte	Yedek Parçaları / Spare Parts / Ersatzteile		
		Ölçü Aralığı Boring Range	WF	OAL		Sıkma Vidası Screw Schraube	Tork Anahtar Torx Key Torx-Schlüssel	
AKCR 28-38	●	28-38	12.8	23	CC.T 0602..	4008-M2.5x6	82-T08	
AKCR 36-50	●	36-50	15.8	32				
AKCR 36-50-09	●	36-50	15.8	32				
AKCR 50-68	●	50-68	19.7	40	CC.T 09T3..	4015-M3.5x8	80-T15	
AKCR 50-68-12	●	50-68	19.7	40				
AKCR 68-90	●	68-90	22.7	54				
AKCR 90-120	●	90-120	27.7	70	CC.T 1204..	1020-M5x11	80-T20	
AKCR 120-160	●	120-160	31.7	95				
AKCR 160-800	●	160-800	31.7	120				

R: Sağ / Right / Rechts/ L: Sol / Left / Links

● Stokta / In Stock / Auf Lager ○ Stokta Yok / Non Stock Item / Kein Lagerartikel, Lieferzeit auf Anfrage  
ISO Ucuna Uygunudur. / Compatible with ISO Insert. / Kompatibel mit ISO Wendeplatten.

Sipariş Örneği/Ordering Example/Bestellbeispiel  
1 ad./pcs./stück AKSR 18-22

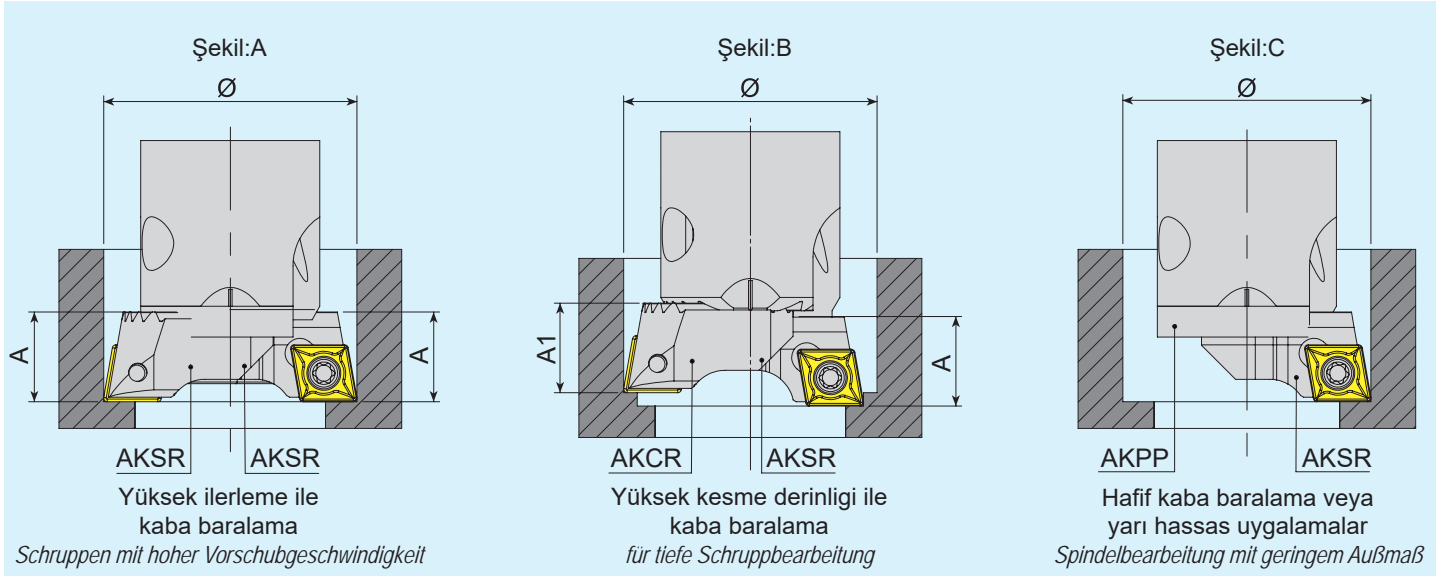

1. Kesici kenarların radyal ayarı, takım ölçme ekipmanı ile yapılmalıdır.
2. İki uçlu baralama takımı, ağır talaş kaldırma işlemini içeren kaba baralama işlemleri içindir. Çift uçlu baralama takımı ile:
  - Yüksek ilerleme oranında kaba baralama işlemleri için, aynı düzlemdeki iki AKSR kartuşu, aynı radyal mesafeye ayarlanır. (Şekil A)
  - Aynı düzlemde olmayan bir AKCR kartuşu ve bir AKSR kartuşu yüksek derinlikte kaba baralama işlemleri için kullanılır. (Şekil B)
  - i. Kaba baralama işleminde, alınacak pases miktarı tam olarak ikiye bölünüp, düzgün bir kesim sağlanmış olur, ancak bu durumda tur başına ilerleme tek ağız olarak hesaplanmalıdır. ( $f=f_1$ )
  - ii. Hassas baralama işleminde, alınacak pases miktarı AKSR kartuş için ara kaba olarak ve AKCR kartuş için hassas bara olarak çaplar ayarlanır ve bu sayede bazı ara kaba işleme ihtiyacı kalmaz.
3. Tek kartuşlu baralama takımları, normal talaş kaldırma işlemini içeren kaba ve hassas baralama işlemleri içindir. Dişleri koruma plakası, AKPP daima kullanılmalıdır. (Şekil C)

1. Radial setting of the cutting edges should be carried out with tool presetting equipment.
2. Boring bars fitted with two insert pockets are for roughing operations involving heavy chip removal. The double-insert boring bars include:
  - Two AKSR cartridges on the same plane with two cutting edges set at identical radial distance for high feed rate roughing operations. (fig. A)
  - An AKCR cartridge and an AKSR cartridge not on the same plane for high-depth roughing operations. (fig. B)
  - i. With the rough boring operation, this allows double the cutting width, using only a single feed rate. ( $f=f_1$ )
  - ii. With the finish boring operation, the cutting width is divided so that some of the intermediate machining can be omitted.
3. Boring bars fitted with a single cartridge are for roughing and finishing operations involving normal chip removal. The serrated surface protection plate AKPP should always be used (fig. C)

1. Die radiale Einstellung der Schneiden sollte auf einem Voreinstellgerät durchgeführt werden.
2. Spindelköpfe, die mit 2 Kassetten bestückt sind, werden für die Schrubbearbeitung eingesetzt. Doppelte Kassetten beinhalten:
  - Für die Schrubbearbeitung mit hoher Vorschubgeschwindigkeit sind zwei AKSR-Kassetten in derselben Höhe auf denselben radialen Abstand einzustellen ( Abbildung A )
  - Eine AKCR-Kassette und eine AKSR-Kassette, die nicht in derselben Ebene liegen, werden für tiefe Schrubbearbeitungen eingesetzt.
  - i. Bei einer Schrubbearbeitung kann die Schnitttiefe verdoppelt werden. Bitte nur eine Schneide zur Vorschubberechnung verwenden ( $f=f_1$ ).
  - ii. Bei der Schlichtbearbeitung wird die Schnitttiefe halbiert. Weitere zusätzliche Bearbeitungsdurchgänge werden überflüssig.
3. Bohrköpfe mit einer einzelnen Kassette können sowohl für Schlicht- als auch für Schrubb-Operationen eingesetzt werden. Voraussetzung hierfür ist eine gute Spanabfuhr. Zum Schutz der verzahnten Oberfläche des Bohrkörpers sollte immer die Abdeckung AKPP verwendet werden (siehe Abb.C).



*konusulan  
the spoken kalite...  
quality...*

**FREZELEME TAKIMLARI**  
MILLING TOOLS  
FRÄSWERKZEUGE



AKKO **A** **EM** **90** **L** - **A** **P** **10**

1 2 3 4 5 6 7

**D12** - **W16** - **L100** - **Z01** - **H**

8 9 10 11 12

**2** Kesiş Stili / Cutter Style / Fräswerkzeug-Typ

FM: Yüzey Frezeleme Takımları / Face Milling Tools / Eck-und Planfräsköpfe  
EM: Alın ve Yüzey Parmak Frezeleri / End Face Milling Tools / Schaftfräser  
CM: Pah Kırma Parmak Frezeleri / Chamfering End Milling Tools / Fasfräser  
HM: Helis Parmak Frezeleri / Helix End Milling Tools / Schaftfräser Helix  
TSM: T Kanal Frezeleri / T Slot Milling Tools / T-Nutenfräser  
HFM: Yüksek İlerleme Frezeleme Takımları / High Feed Milling Tools / Fräser für hohe Vorschübe  
PMR: Küresel Uçlu Parmak Frezeleri / Ball Nose End Milling Tools / Kugel und Kopierfräser  
SDM: Disk Frezeler / Slot Disc Milling / Scheibenfräser  
CBM: Silindirik Alyan Başlı Vida Havşalarını Açma Frezeleri / Countersink Milling Tool for Cylindrical Allen Head Screws  
Fräswerkzeug für zylindrische Inbusschrauben

**3** Freze Yanaşma Açısı / Lead Angle / Anstellwinkel

90° - 75° - 60° - 45°  
20° - 15° - 11° - 5° - 0°

**4** Freze Yanaşma Açısı / Lead Angle / Ausführung

L: Sol - Left / Links  
C: Baskı Pabuçu - Clamp / Spannpratze  
S: Altlık - Shim / Unterlage  
CL: Baskı Pabuçlu Sol Yön - Left Way with Clamp  
Spannspratze links  
CS: Baskı Pabuçlu Altlıklı - Clamp with Shim  
Spannspratze mit Unterlage  
CSL: Baskı Pabuçlu Altlıklı Sol Yön - Left Way Clamp with Shim  
Spannspratze mit Unterlage Links

**5** Uç Tipi / Type of Insert / Plattenform

<b>C</b>	<b>D</b>	<b>E</b>	<b>K</b>
<b>L</b>	<b>R</b>	<b>S</b>	<b>T</b>
<b>V</b>	<b>W</b>	<b>A</b>	<b>B</b>
<b>H</b>	<b>M</b>	<b>O</b>	<b>P</b>

**6** Serbest Uç Açısı / Clearance angle of Insert  
Freiwinkel der Wendeschneidplatte

<b>A</b>	<b>B</b>	<b>C</b>
<b>D</b>	<b>E</b>	<b>F</b>
<b>G</b>	<b>N</b>	<b>P</b>

**7** Kesme Kenar Uzunluğu  
Cutting Edge Length  
Länge der Schneidkante

<b>A</b>	<b>L</b>
<b>R</b>	<b>S</b>
<b>T</b>	

**8** Takım Çapı / Tool Diameter / Werkzeug-ø

**9** Montaj Formu ve Çapı / Assembly Form and Diameter / Schaft-ø und Form

A, B, C, D: ISO'ya göre montaj formu / Assembly Form and Diameter / Art der Montage und Durchmesser  
Silindirik Şaft / Cylindrical Shank / Zylindrischer Schaft  
W: Weldon

**10** Takım Boyu / Tool Length / Werkzeug Länge

**11** Etkili Diş Adedi / Number of Effective Tooth / Effektive Zähnezahl

**12** İçten Soğutmalı / With Coolant Hole / Innenkühlung

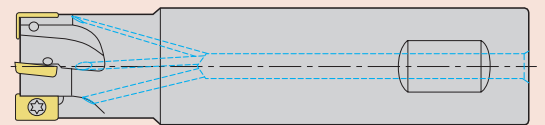

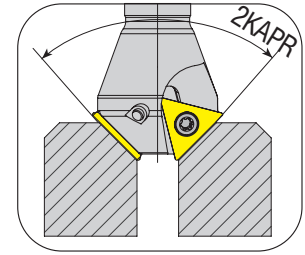
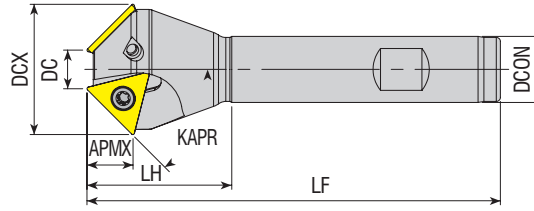

**Takım Kodu**  
**Ordering Code**  
*Bestell-Bezeichnung*

Stok  
Stock  
Lager

Takım Ölçüleri (mm)  
Dimension (mm)  
Abmessung (mm)

Kesici Uç  
Insert  
Wendeschneidplatte

Yedek Parçaları / Spare Parts / Ersatzteile

Sıkma Vidası  
Screw  
Schraube

Tork Anahtar  
Torx Key  
Torx-Schlüssel

KAPR DC DCX DCON LF LH ZEFP APMX



ACM10-TC16-D17X22-W16-L90-Z01	●	10°	17	22	16	90	30	1	15.2	TC.T 16T304	4015-M3.5x9	80-T15	
ACM15-TC16-D17X24-W16-L90-Z01	●	15°	17	24	16	90	30	1	14.9				
ACM15-TC16-D22X29-W16-L100-Z01	●	15°	22	29	16	100	30	1	14.9				
ACM15-TC16-D30X37-W20-L100-Z02	●	15°	30	37	20	100	35	2	14.9				
ACM15-TC16-D35X42-W20-L100-Z03	●	15°	35	42	20	100	38	3	14.9				
ACM15-TC16-D52X59-W25-L110-Z03	●	15°	52	59	25	110	40	3	14.9				
ACM17.5-TC16-D17X25-W16-L90-Z01	●	17.5°	17	25	16	90	30	1	14.7				
ACM18.5-TC16-D21.3X30-W20-L100-Z02	●	18.5°	21.3	30	20	100	30	2	13.5				TC.T 16T308
ACM20-TC16-D12X22-W16-L100-Z01	●	20°	12	22	16	100	30	1	14.4				
ACM20-TC16-D17X27-W16-L100-Z01	●	20°	17	27	16	100	30	1	14.4				
ACM20-TC16-D23X33-W20-L100-Z02	●	20°	23	33	20	100	30	2	14.4				
ACM20-TC16-D28X38-W20-L100-Z02	●	20°	28	38	20	100	35	2	14.4				
ACM20-TC16-D35X45-W20-L100-Z03	●	20°	35	45	20	100	40	3	14.4				
ACM20-TC16-D39X49-W20-L100-Z03	●	20°	39	49	20	100	40	3	14.4				
ACM20-TC16-D45X55-W25-L110-Z03	●	20°	45	55	25	110	40	3	14.4				
ACM20-TC16-D51X61-W25-L110-Z03	●	20°	51	61	25	110	40	3	14.4				
ACM22.5-TC16-D17X28-W16-L100-Z01	●	22.5°	17	28	16	100	30	1	14.2				
ACM25-TC16-D17X29-W16-L100-Z01	●	25°	17	29	16	100	30	1	13.9				
ACM30-TC16-D6X20-W16-L100-Z01	●	30°	6	20	16	100	30	1	13.3				
ACM30-TC16-D15X30-W16-L100-Z01	●	30°	15	30	16	100	30	1	13.3				
ACM30-TC16-D17.5X32.5-W20-L100-Z02	●	30°	17.5	32.5	20	100	30	2	13.3				
ACM30-TC16-D20X35-W16-L100-Z02	●	30°	20	35	16	100	35	2	13.3				
ACM30-TC16-D30X45-W20-L100-Z02	●	30°	30	45	20	100	40	2	13.3				
ACM30-TC16-D35X50-W20-L100-Z03	●	30°	35	50	20	100	40	3	13.3				
ACM30-TC16-D45X60-W25-L110-Z03	●	30°	45	60	25	110	40	3	13.3				
<b>new</b> ACM40-TC16-D18x37-W20-L100-Z02	●	40°	18	37	20	100	40	2	11.7				
ACM45-TC09-D7X18-W16-L100-Z02	●	45°	7	18	16	100	25	2	5.9	TC.T 090204	3007-M2.2x4.6	82-T07	
ACM45-TC11-D11X24-W16-L100-Z02	●	45°	11	24	16	100	25	2	6.9	TC.T 110204	3008-M2.5x6	82-T08	
ACM45-TC16-D5X26-W16-L100-Z01	●	45°	5	26	16	100	30	1	10.8				
ACM45-TC16-D10X31-W16-L100-Z02	●	45°	10	31	16	100	35	2	10.8				
ACM45-TC16-D10X31-W20-L100-Z02	●	45°	10	31	20	100	35	2	10.8				
ACM45-TC16-D18X39-W16-L100-Z02	●	45°	18	39	16	100	40	2	10.8				
ACM45-TC16-D18X39-W20-L100-Z02	●	45°	18	39	20	100	40	2	10.8				
ACM45-TC16-D20X41-W20-L100-Z02	●	45°	20	41	20	100	40	2	10.8				
ACM45-TC16-D30X51-W20-L100-Z02	●	45°	30	51	20	100	40	2	10.8				
<b>new</b> ACM50-TC16-D16X39-W20-L100-Z03	●	50°	16	39	20	100	40	3	9.8				
ACM55-TC16-D16X40-W20-L100-Z03	●	55°	16	40	20	100	40	3	8.7				
ACM62-TC16-D14X40-W20-L100-Z03	●	62°	14	40	20	100	40	3	7.1				
ACM72-TC16-D14X42-W20-L100-Z03	●	72°	14	42	20	100	40	3	4.6				

R: Sağ / Right / Rechts/ L: Sol / Left / Links

● Stokta / In Stock / Auf Lager ○ Stokta Yok / Non Stock Item / Kein Lagerartikel, Lieferzeit auf Anfrage

ISO Uçuna Uygundur. / Compatible with ISO Insert. / Kompatibel mit ISO Wendeplatten.

Sipariş Örneği/Ordering Example/Bestellbeispiel

1 ad./pcs./stück ACM10-TC16-D17X22-W16-L90-Z01

Kesme Hesabı : S 377/ Cutting Calculation : P 377 / Schnittberechnung : P 377

➤ **S-SİSTEM PAH FREZELER**  
**S-SYSTEM CHAMFERING END MILLS**  
**S-SYSTEM FASFRÄSER**

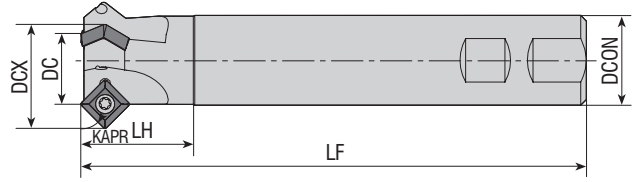

Takım Kodu Ordering Code Bestell-Bezeichnung	Stok Stock Lager	Takım Ölçüleri (mm) Dimension (mm) Abmessung (mm)								Kesici Uç Insert Wendeschneidplatte	Yedek Parçaları / Spare Parts / Ersatzteile	
		KAPR	DC	DCX	DCON	LF	LH	ZEFP	a		Sıkma Vidası Screw Schraube	Tork Anahtar Torx Key Torx-Schlüssel
ACM45-SP1104-D12x26-W20-L150-Z01	●	45°	12	26	20	150	30	1	-	SPGT 110408	4015-M4x9	80-T15
ACM45-SP1104-D25x39-W25-L150-Z02	●	45°	25	39	25	150	35	2	-			
ACM45-SP1104-D32x46-W32-L150-Z03	●	45°	32	46	32	150	40	3	-			

ZCC Ucuna Uygun. / Compatible with ZCC Insert. / Kompatibel mit ZCC Wendeplatten.

➤ **HELİS PAH FREZELEME TAKIMLARI**  
**HELIX CHAMFER MILLING TOOLS**  
**HELIX-FASFRÄSER**

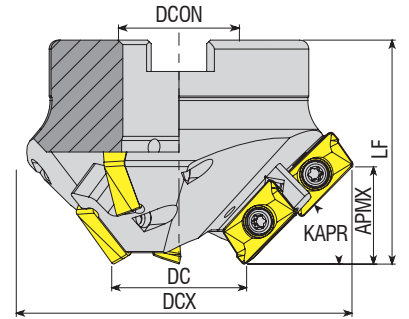

Takım Kodu Ordering Code Bestell-Bezeichnung	Stok Stock Lager	Takım Ölçüleri (mm) Dimension (mm) Abmessung (mm)								Kesici Uç Insert Wendeschneidplatte	Yedek Parçaları / Spare Parts / Ersatzteile	
		ZEFP		KAPR	DC	DCX	DCON	APMX	LF		Sıkma Vidası Screw Schraube	Tork Anahtar Torx Key Torx-Schlüssel
		Toplam Total Gesamt	Etkili Effective Effektiv									
AHM15-AP16-D35x93-A27-Z0306-H	●	6	3	15	35	93	27	8	50	AP. 1604..	4015-M4x11	80-T15
AHM30-AP16-D35x87-A27-Z0306-H	●	6	3	30	35	87	27	15	50			
AHM45-AP16-D35x77-A27-Z0306-H	●	6	3	45	35	77	27	21.5	50			
AHM60-AP16-D35x65-A22-Z0306-H	●	6	3	60	35	65	22	26.5	50			
AHM75-AP16-D35x50-A22-Z0306-H	●	6	3	75	35	50	22	29.5	50			

R: Sağ / Right / Rechts/ L: Sol / Left / Links

● Stokta / In Stock / Auf Lager ○ Stokta Yok / Non Stock Item / Kein Lagerartikel, Lieferzeit auf Anfrage  
 ISO Ucuna Uygun. / Compatible with ISO Insert. / Kompatibel mit ISO Wendeplatten.

Sipariş Örneği/Ordering Example/Bestellbeispiel

1 ad./pcs./stück ACM45-SP1104-D12x26-W20-L150-Z01

Kesme Hesabı : S 377/ Cutting Calculation : P 377 / Schnittberechnung : P 377

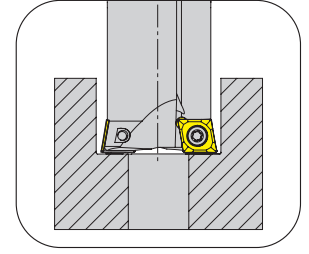
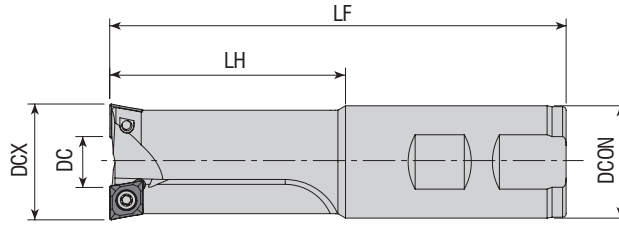

**Takım Kodu**  
**Ordering Code**  
 Bestell-Bezeichnung

Stok  
 Stock  
 Lager

Takım Ölçüleri (mm)  
 Dimension (mm)  
 Abmessung (mm)

Kesici Uç  
 Insert  
 Wendeschneidplatte

Yedek Parçaları / Spare Parts / Ersatzteile

Sıkma Vidası  
 Screw  
 Schraube

Tork Anahtar  
 Torx Key  
 Torx-Schlüssel

Takım Kodu Ordering Code Bestell-Bezeichnung	Stok Stock Lager	DC	DCX	DCON	LH	LF	Kullanılan Vidalar For Screws Für Schraube	Kesici Uç Insert Wendeschneidplatte	Sıkma Vidası Screw Schraube	Tork Anahtar Torx Key Torx-Schlüssel
ACBM-CC06-D17X6-W16-L150-Z02	●	6	17	16	30	150	-	CC.. 060204	3008-M2.5x6	82-T08
ACBM-CC06-D18X7-W16-L100-Z02-H	●	7	18	16	32	100	M10			
ACBM-CC06-D18X7-W16-L160-Z02-H	●	7	18	16	32	160	M10			
ACBM-CC06-D20X9-W20-L100-Z02-H	●	9	20	20	40	100	M12			
ACBM-CC06-D20X9-W20-L160-Z02-H	●	9	20	20	38	160	M12			
ACBM-CC09-D26X8.5-W25-L130-Z02-H	●	8.5	26	25	50	130	M16	CC.. 09T304	4015-M3.5x9	80-T15
ACBM-CC09-D26X8.5-W25-L200-Z02-H	●	8.5	26	25	50	200	M16			
ACBM-CC09-D30X12.5-W32-L130-Z02-H	●	12.5	30	32	65	130	-			
ACBM-CC09-D33X15.5-W32-L130-Z02-H	●	15.5	33	32	65	130	M20			
ACBM-CC09-D33X15.5-W32-L200-Z02-H	●	15.5	33	32	65	200	M20			
ACBM-SP06-D15X4-W16-L160-Z02-H	●	4	15	16	80	160	M8	SP. 060204	3007-M2.2x4.6	82-T07

R: Sağ / Right / Rechts L: Sol / Left / Links

● Stokta / In Stock / Auf Lager ○ Stokta Yok / Non Stock Item / Kein Lagerartikel, Lieferzeit auf Anfrage  
 ISO Ucuna Uygundur. / Compatible with ISO Insert. / Kompatibel mit ISO Wendepplatten.

Sipariş Örneği/Ordering Example/Bestellbeispiel

1 ad./pcs./stück ACBM-CC06-D17X6-W16-L150-Z02

Kesme Hesabı : S 377/ Cutting Calculation : P 377 / Schnittberechnung : P 377



## S-SİSTEM YÜZEY PARMAK FREZELER

S-SYSTEM END MILLS

S-SYSTEM SCHAFTFRÄSER

KAPR=90°

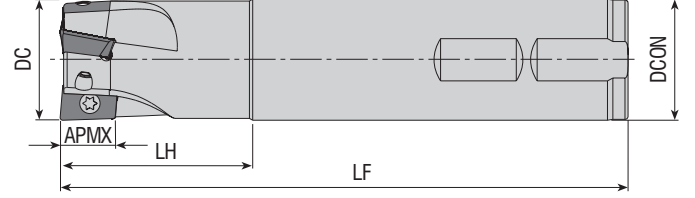

Takım Kodu Ordering Code Bestell-Bezeichnung	Stok Stock Lager	Takım Ölçüleri (mm) Dimension (mm) Abmessung (mm)						Kesici Uç Insert Wendeschneidplatte	Yedek Parçaları / Spare Parts / Ersatzteile	
		DC	ZEFP	DCON	LF	LH	APMX		Sıkma Vidası Screw Schraube	Tork Anahtar Torx Key Torx-Schlüssel
AEM90-AD1505-D25-W25-L150-Z02	●	25	2	25	150	50	14.30	AD.. 1505..	4015-M4x9	80-T15
AEM90-AD1505-D30-W25-L150-Z03	●	30	3	25	150	40	14.30			
AEM90-AD1505-D32-W32-L150-Z03	●	32	3	32	150	50	14.30			

ISCR Ucuna Uygunur. / Compatible with ISCR Insert. / Kompatibel mit ISCR Wendepplatten.

KAPR=90°

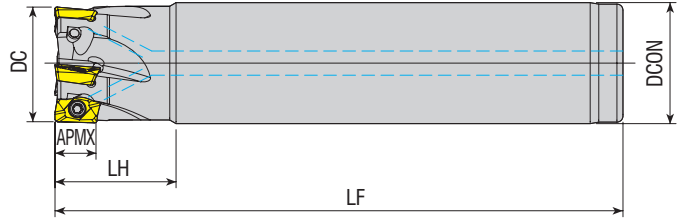

Takım Kodu Ordering Code Bestell-Bezeichnung	Stok Stock Lager	Takım Ölçüleri (mm) Dimension (mm) Abmessung (mm)						Kesici Uç Insert Wendeschneidplatte	Yedek Parçaları / Spare Parts / Ersatzteile	
		DC	ZEFP	DCON	LF	LH	APMX		Sıkma Vidası Screw Schraube	Tork Anahtar Torx Key Torx-Schlüssel
AEM90-AD07-D10-C08-L90-Z02-H	●	10	2	8	90	16	6	ADMX 0702..	3006-M2x3.3	82-T06
AEM90-AD07-D10-C10-L80-Z02-H	●	10	2	10	80	16	6		3006-M2x3.1	
AEM90-AD07-D12-C10-L80-Z03-H	●	12	3	10	80	18	6		3006-M2x3.3	
AEM90-AD07-D12-C12-L90-Z03-H	●	12	3	12	90	18	6		3006-M2x3.6	
AEM90-AD07-D16-C16-L110-Z04-H	●	16	4	16	110	19	6		3006-M2x4	
AEM90-AD07-D20-C20-L125-Z05-H	●	20	5	20	125	20	6			
AEM90-AD07-D25-C25-L140-Z06-H	●	25	6	25	140	24	6			
AEM90-AD11-D16-C16-L135-Z02-H	●	16	2	16	135	24	9	ADMX 11T3..	3008-M2.5x5	82-T08
AEM90-AD11-D18-C16-L135-Z02-H	●	18	2	16	135	15	9			
AEM90-AD11-D18-C16-L160-Z02-H	●	18	2	16	160	15	9			
AEM90-AD11-D20-C20-L150-Z02-H	●	20	2	20	150	50	9			
AEM90-AD11-D20-C20-L150-Z03-H	●	20	3	20	150	50	9			
AEM90-AD11-D22-C20-L150-Z03-H	●	22	3	20	150	15	9			
AEM90-AD11-D22-C20-L200-Z03-H	●	22	3	20	200	15	9			
AEM90-AD11-D25-C25-L170-Z03-H	●	25	3	25	170	50	9			
AEM90-AD11-D25-C25-L170-Z04-H	●	25	4	25	170	50	9			
AEM90-AD11-D28-C25-L165-Z04-H	●	28	4	25	165	17	9			
AEM90-AD11-D28-C25-L200-Z04-H	●	28	4	25	200	17	9			
AEM90-AD11-D30-C25-L165-Z04-H	●	30	4	25	165	19	9			
AEM90-AD11-D30-C25-L200-Z04-H	●	30	4	25	200	19	9			
AEM90-AD11-D32-C32-L195-Z05-H	●	32	5	32	195	50	9			

R: Sağ / Right / Rechts/ L: Sol / Left / Links

● Stokta / In Stock / Auf Lager ○ Stokta Yok / Non Stock Item / Kein Lagerartikel, Lieferzeit auf Anfrage

PRMT Ucuna Uygunur. / Compatible with PRMT Insert. / Kompatibel mit PRMT Wendepplatten.

Sipariş Örneği/Ordering Example/Bestellbeispiel

1 ad./pcs./stück AEM90-AD1505-D25-W25-L150-Z02

Kesme Hesabı : S 377/ Cutting Calculation : P 377 / Schnittberechnung : P 377



www.akkо.com.tr



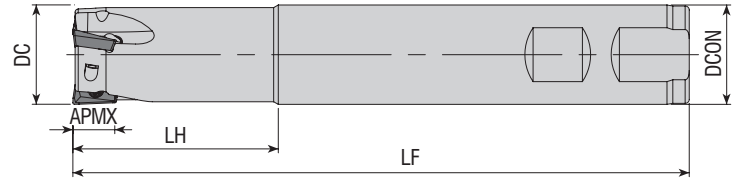

Takım Kodu Ordering Code Bestell-Bezeichnung	Stok Stock Lager	Takım Ölçüleri (mm) Dimension (mm) Abmessung (mm)						Kesici Uç Insert Wendeschneidplatte	Yedek Parçaları / Spare Parts / Ersatzteile		
		DC	ZEFP	DCON	LF	LH	APMX		Sıkma Vidası Screw Schraube	Tork Anahtar Torx Key Torx-Schlüssel	
AEM90-AD0803-D16-W16-L150-Z02	●	16	2	16	150	30	8	ADMT 0803..	3008-M2.5x5		
AEM90-AD0803-D17-W16-L150-Z02	●	17	2	16	150	30	8				
AEM90-AD0803-D17-W16-L200-Z02	●	17	2	16	200	30	8				
AEM90-AD0803-D20-W20-L150-Z03	●	20	3	20	150	30	8				
AEM90-AD0803-D21-W20-L200-Z03	●	21	3	20	200	30	8				
AEM90-AD10T3-D16-W16-L100-Z02-H	●	16	2	16	100	30	10	ADMT 10T3..	3008-M2.5x6	82-T08	
AEM90-AD10T3-D16-W16-L150-Z02	●	16	2	16	150	40	10				
AEM90-AD10T3-D16-C16-L200-Z02	●	16	2	16	200	50	10				
AEM90-AD10T3-D17-W16-L150-Z02	●	17	2	16	150	30	10				
AEM90-AD10T3-D17-W16-L200-Z02	●	17	2	16	200	30	10				
AEM90-AD10T3-D20-W20-L70-Z03	●	20	3	20	70	30	10				
AEM90-AD10T3-D20-W20-L100-Z03-H	●	20	3	20	100	30	10				
AEM90-AD10T3-D20-W20-L150-Z03	●	20	3	20	150	40	10				
AEM90-AD10T3-D20-C20-L150-Z03	●	20	3	20	150	40	10				
AEM90-AD10T3-D20-C20-L200-Z03	●	20	3	20	200	50	10				
AEM90-AD10T3-D25-W25-L100-Z03-H	●	25	3	25	100	30	10	ADMT 1204..	4010-M3x6	82-T10	
AEM90-AD10T3-D25-W25-L100-Z04-H	●	25	4	25	100	30	10				
AEM90-AD10T3-D25-W25-L150-Z03	●	25	3	25	150	50	10				
AEM90-AD1204-D20-W20-L150-Z02	●	20	2	20	150	50	12				
AEM90-AD1204-D21-C20-L150-Z02	●	21	2	20	150	30	12				
AEM90-AD1204-D22-C20-L150-Z02	●	22	2	20	150	30	12	ADMT 1606..	4015-M4x9	80-T15	
AEM90-AD1204-D25-W25-L150-Z03	●	25	3	25	150	50	12				
AEM90-AD1204-D26-W25-L180-Z03	●	26	3	25	180	30	12				
AEM90-AD1204-D32-W32-L150-Z04	●	32	4	32	150	50	12	ADMT 1606..	4015-M4x9	80-T15	
AEM90-AD1606-D25-W25-L150-Z02	●	25	2	25	150	50	15				
AEM90-AD1606-D32-W32-L150-Z03	●	32	3	32	150	50	15				

R: Sağ / Right / Rechtsl L: Sol / Left / Links

● Stokta / In Stock / Auf Lager ○ Stokta Yok / Non Stock Item / Kein Lagerartikel, Lieferzeit auf Anfrage  
WLTR Ucuna Uygundur. / Compatible with WLTR Insert. / Kompatibel mit WLTR Wendeplatten.

Sipariş Örneği/Ordering Example/Bestellbeispiel

1 ad./pcs./stück AEM90-AD0803-D16-W16-L150-Z02

Kesme Hesabı : S 377 / Cutting Calculation : P 377 / Schnittberechnung : P 377

## S-SİSTEM YÜZEY PARMAK FREZELER

S-SYSTEM END MILLS

S-SYSTEM SCHAFTFRÄSER

KAPR=90°

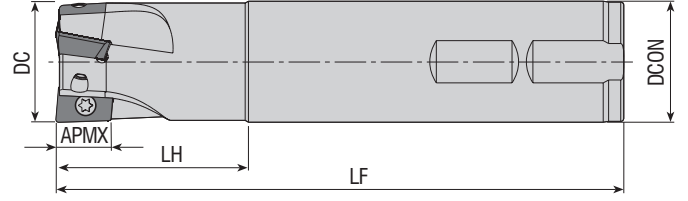

Takım Kodu Ordering Code Bestell-Bezeichnung	Stok Stock Lager	Takım Ölçüleri (mm) Dimension (mm) Abmessung (mm)						Kesici Uç Insert Wendeschneidplatte	Yedek Parçaları / Spare Parts / Ersatzteile	
		DC	ZEPF	DCON	LF	LH	APMX		Sıkma Vidası Screw Schraube	Tork Anahtar Torx Key Torx-Schlüssel
AEM90-AD1003-D16-C16-L150-Z02	●	16	2	16	150	30	8	ADMT 1003..	3008-M2.5x5	82-T08
AEM90-AD1003-D17-C16-L150-Z02	●	17	2	16	150	25	8			
AEM90-AD1003-D20-C20-L200-Z03	●	20	3	20	200	50	8			
AEM90-AD1003-D21-C20-L150-Z03	●	21	3	20	150	25	8			
AEM90-AD1003-D21-C20-L200-Z03	●	21	3	20	200	25	8			
AEM90-AD1003-D25-C25-L200-Z03	●	25	3	25	200	50	8			
AEM90-AD1003-D26-C25-L150-Z03	●	26	3	25	150	30	8			
AEM90-AD1003-D26-C25-L200-Z03	●	26	3	25	200	30	8			
AEM90-AD1505D-D25-W25-L150-Z02	●	25	2	25	150	50	14.3	ADKT 1505..	4015-M4x9 4015-M4x11	80-T15
AEM90-AD1505D-D32-W32-L150-Z03	●	32	3	32	150	50	14.3			

DJT Ucuna Uygundur. / Compatible with DJT Insert. / Kompatibel mit DJT Wendeplatten.

KAPR=90°

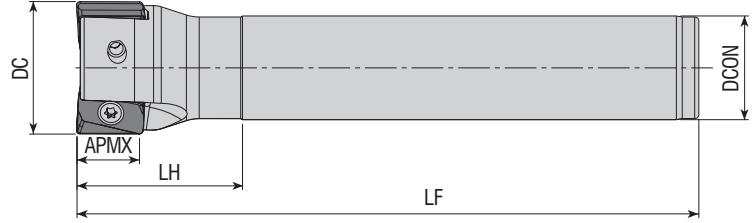

Takım Kodu Ordering Code Bestell-Bezeichnung	Stok Stock Lager	Takım Ölçüleri (mm) Dimension (mm) Abmessung (mm)						Kesici Uç Insert Wendeschneidplatte	Yedek Parçaları / Spare Parts / Ersatzteile	
		DC	ZEPF	DCON	LF	LH	APMX		Sıkma Vidası Screw Schraube	Tork Anahtar Torx Key Torx-Schlüssel
AEM90-AN11-D22-W20-L150-Z02	●	22	2	20	150	30	11	ANGX 1105..	4010-M3x8	82-T10
AEM90-AN11-D25-W25-L150-Z02	●	25	2	25	150	40	11			
AEM90-AN11-D25-C25-L200-Z02	●	25	2	25	200	40	11			
AEM90-AN11-D26-W25-L150-Z02	●	26	2	25	150	40	11			
AEM90-AN11-D28-W25-L150-Z02	●	28	2	25	150	25	11			
AEM90-AN11-D32-W32-L150-Z03	●	32	3	32	150	50	11			
AEM90-AN11-D32-C32-L200-Z03	●	32	3	32	200	50	11			
AEM90-AN11-D40-W32-L150-Z04	●	40	4	32	150	40	11			

R: Sağ / Right / Rechts / L: Sol / Left / Links

● Stokta / In Stock / Auf Lager ○ Stokta Yok / Non Stock Item / Kein Lagerartikel, Lieferzeit auf Anfrage  
ZCC Ucuna Uygundur. / Compatible with ZCC Insert. / Kompatibel mit ZCC Wendeplatten.

Sipariş Örneği/Ordering Example/Bestellbeispiel

1 ad./pcs./stück AEM90-AD1003-D16-C16-L150-Z02

Kesme Hesabı : S 377 / Cutting Calculation : P 377 / Schnittberechnung : P 377



www.akkо.com.tr

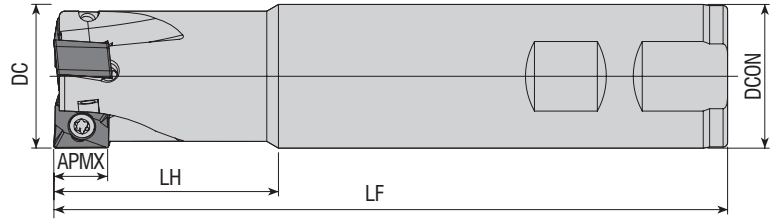

Takım Kodu Ordering Code Bestell-Bezeichnung	Stok Stock Lager	Takım Ölçüleri (mm) Dimension (mm) Abmessung (mm)						Kesici Uç Insert Wendeschneidplatte	Yedek Parçaları / Spare Parts / Ersatzteile		
		DC	ZEFP	DCON	LF	LH	APMX		Sıkma Vidası Screw Schraube	Tork Anahtar Torx Key Torx-Schlüssel	
AEM90-AN1207-D25-W25-L150-Z02	●	25	2	25	150	40	10	ANKX 1207..		4015-M4x11	
AEM90-AN1207-D32-W32-L150-Z03	●	32	3	32	150	50	10				
AEM90-AN1207-D40-W32-L150-Z04	●	40	4	32	150	40	10				

XTC-GSC Ucuna Uygun. / Compatible with XTC-GSC Insert. / Kompatibel mit XTC-GSC Wendeplatten.

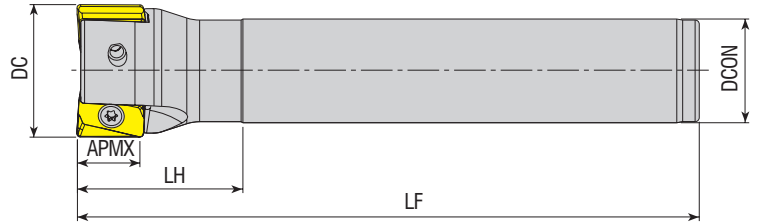

Takım Kodu Ordering Code Bestell-Bezeichnung	Stok Stock Lager	Takım Ölçüleri (mm) Dimension (mm) Abmessung (mm)						Kesici Uç Insert Wendeschneidplatte	Yedek Parçaları / Spare Parts / Ersatzteile		
		DC	ZEFP	DCON	LF	LH	APMX		Sıkma Vidası Screw Schraube	Tork Anahtar Torx Key Torx-Schlüssel	
AEM90-AN1607-D32-C25-L150-Z02	●	32	2	25	150	50	15	AN.X 1607..		4015-M4x11	
AEM90-AN1607-D40-C32-L150-Z03	●	40	3	32	150	50	15				

R: Sağ / Right / Rechts/ L: Sol / Left / Links

● Stokta / In Stock / Auf Lager ○ Stokta Yok / Non Stock Item / Kein Lagerartikel, Lieferzeit auf Anfrage

TGTC Ucuna Uygun. / Compatible with TGTC Insert. / Kompatibel mit TGTC Wendeplatten.

Sipariş Örneği/Ordering Example/Bestellbeispiel

1 ad./pcs./stück AEM90-AN1207-D25-W25-L150-Z02

Kesme Hesabı : S 377 / Cutting Calculation : P 377 / Schnittberechnung : P 377

KAPR=90°

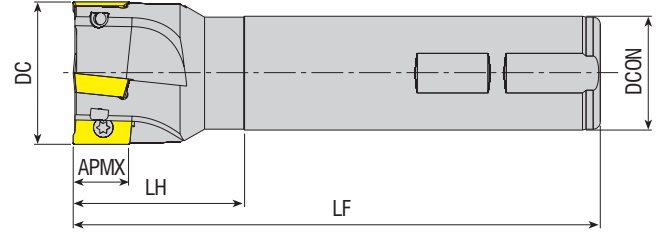

Takım Kodu Ordering Code Bestell-Bezeichnung	Stok Stock Lager	Takım Ölçüleri (mm) Dimension (mm) Abmessung (mm)						Kesici Uç Insert Wendeschneidplatte	Yedek Parçaları / Spare Parts / Ersatzteile	
		DC	ZEFP	DCON	LF	LH	APMX		Sıkma Vidası Screw Schraube	Tork Anahtar Torx Key Torx-Schlüssel
AEM90-AP06-D10-C10-L120-Z02	●	10	2	10	120	20	5.6	APMT 0602.. KRLY UCUNA UYGUNDUR. FOR KRLY INSERT. Kompatibel mit KRLY	3006-M1.8x4	82-T06
AEM90-AP06-D12-C12-L120-Z02	●	12	2	12	120	20	5.6			
AEM90-AP0903-D12-C16-L080-Z01-H	●	12	1	16	80	30	9	APMT 0903..  KRLY UCUNA UYGUNDUR. FOR KRLY INSERT. Kompatibel mit KRLY	3008-M2.5x5	
AEM90-AP0903-D16-C16-L090-Z02	●	16	2	16	90	30	9			
AEM90-AP0903-D16-C16-L150-Z02	●	16	2	16	150	30	9			
AEM90-AP0903-D17-C16-L150-Z02	●	17	2	16	150	30	9			
AEM90-AP0903-D18-C16-L090-Z02-H	●	18	2	16	90	30	9			
AEM90-AP0903-D20-C20-L110-Z03	●	20	3	20	110	30	9			
AEM90-AP0903-D20-C20-L150-Z02	●	20	2	20	150	30	9			
AEM90-AP0903-D20-C20-L200-Z02	●	20	2	20	200	100	9			
AEM90-AP0903-D21-C20-L150-Z02	●	21	2	20	150	30	9			
AEM90-AP0903-D25-C25-L120-Z03	●	25	3	25	120	30	9			
AEM90-AP0903-D25-C25-L150-Z03	●	25	3	25	150	30	9			
AEM90-AP0903-D25-C25-L200-Z02	●	25	2	25	200	100	9			
AEM90-AP09-D16-C16-L100-Z02-H	●	16	2	16	100	30	8.8	APKT 09T3..  TGTC UCUNA UYGUNDUR. FOR TGTC INSERT. Kompatibel mit TGTC	3008-M2.5x5	82-T08
AEM90-AP09-D16-C15-L150-Z02	●	16	2	15	150	25	8.8			
AEM90-AP09-D16-W16-L150-Z02-H	●	16	2	16	150	25	8.8			
AEM90-AP09-D16-C16-L200-Z02-H	●	16	2	16	200	100	8.8			
AEM90-AP09-D17-C16-L150-Z02	●	17	2	16	150	25	8.8			
AEM90-AP09-D17-C16-L180-Z02-H	●	17	2	16	180	25	8.8			
AEM90-AP09-D20-C20-L150-Z03-H	●	20	3	20	150	50	8.8			
AEM90-AP09-D20-C20-L200-Z03-H	●	20	3	20	200	100	8.8			
AEM90-AP09-D20-C20-L250-Z02-H	●	20	2	20	250	150	8.8			
AEM90-AP09-D21-C20-L150-Z03	●	21	3	20	150	25	8.8			
AEM90-AP09-D21-C20-L180-Z02-H	●	21	2	20	180	25	8.8			
AEM90-AP09-D26-C25-L150-Z04	●	26	4	25	150	30	8.8			
AEM90-AP10-D10-C10-L100-Z01	●	10	1	10	100	20	10	AP. 1003..  ISO UCUNA UYGUNDUR. FOR ISO INSERT. Kompatibel mit ISO	3008-M2.5x5	
AEM90-AP10-D12-C16-L100-Z01-H	●	12	1	16	100	30	10			
AEM90-AP10-D12-W16-L100-Z01-H	●	12	1	16	100	30	10			
AEM90-AP10-D12-W16-L150-Z01	●	12	1	16	150	38	10			
AEM90-AP10-D14-W16-L100-Z01-H	●	14	1	16	100	30	10			
AEM90-AP10-D14-W16-L150-Z01	●	14	1	16	150	38	10			
AEM90-AP10-D16-C16-L100-Z02-H	●	16	2	16	100	30	10			
AEM90-AP10-D16-W16-L85-Z02-H	●	16	2	16	85	30	10			
AEM90-AP10-D16-W16-L100-Z02-H	●	16	2	16	100	30	10			
AEM90-AP10-D16-W16-L150-Z02-H	●	16	2	16	150	50	10			
AEM90-AP10-D16-W16-L200-Z02	●	16	2	16	200	100	10			
AEM90-AP10-D16-C16-L120-Z02-H	●	16	2	16	120	30	10			

R: Sağ / Right / Rechts/ L: Sol / Left / Links

● Stokta / In Stock / Auf Lager ○ Stokta Yok / Non Stock Item / Kein Lagerartikel, Lieferzeit auf Anfrage



www.akkо.com.tr

Sipariş Örneği/Ordering Example/Bestellbeispiel

1 ad./pcs./stück AEM90-AP06-D10-C10-L120-Z02

Kesme Hesabı : S 377/ Cutting Calculation : P 377 / Schnittberechnung : P 377

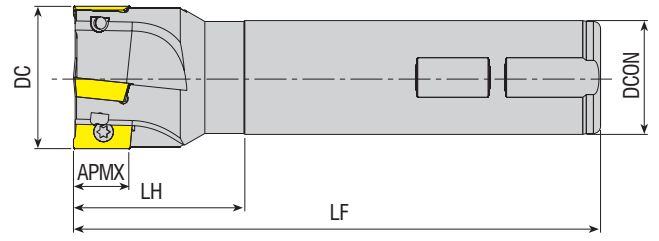
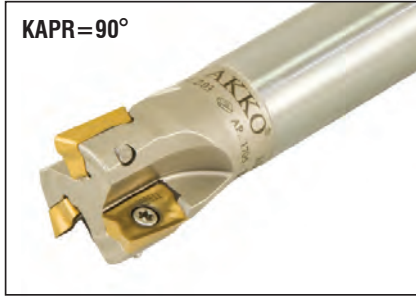

**Takım Kodu**  
**Ordering Code**  
*Bestell-Bezeichnung*

Stok  
Stock  
Lager

Takım Ölçüleri (mm)  
Dimension (mm)  
Abmessung (mm)

Kesici Uç  
Insert  
Wendeschneidplatte

Yedek Parçaları / Spare Parts / Ersatzteile

Sıkma Vidası  
Screw  
Schraube

Tork Anahtar  
Torx Key  
Torx-Schlüssel

DC ZEFP DCON LF LH APMX



AEM90-AP10-D16-C16-L150-Z02	●	16	2	16	150	50	10
AEM90-AP10-D16-C16-L150-Z02-H	●	16	2	16	150	50	10
AEM90-AP10-D16-W16-L150-Z02	●	16	2	16	150	50	10
AEM90-AP10-D16-C16-L200-Z02	●	16	2	16	200	100	10
AEM90-AP10-D16-C16-L200-Z02-H	●	16	2	16	200	100	10
AEM90-AP10-D16-C16-L250-Z02	●	17	2	16	150	30	10
new AEM90-AP10-D17-C16-L150-Z02	●	17	2	16	250	150	10
AEM90-AP10-D18-W16-L100-Z02-H	●	18	2	16	100	30	10
AEM90-AP10-D18-W16-L150-Z02	●	18	2	16	150	30	10
new AEM90-AP10-D20-C19-L180-Z02	●	20	2	19	180	30	10
AEM90-AP10-D20-C20-L100-Z03-H	●	20	3	20	100	30	10
new AEM90-AP10-D20-W20-L90-Z03-H	●	20	3	20	90	30	10
AEM90-AP10-D20-W20-L100-Z03-H	●	20	3	20	100	30	10
AEM90-AP10-D20-C20-L120-Z03-H	●	20	3	20	120	30	10
AEM90-AP10-D20-C20-L150-Z03	●	20	3	20	150	50	10
AEM90-AP10-D20-C20-L150-Z03-H	●	20	3	20	150	50	10
AEM90-AP10-D20-W20-L150-Z03	●	20	3	20	150	50	10
AEM90-AP10-D20-C20-L200-Z02	●	20	2	20	200	100	10
AEM90-AP10-D20-C20-L200-Z03-H	●	20	3	20	200	100	10
AEM90-AP10-D20-C20-L250-Z02	●	20	2	20	250	150	10
AEM90-AP10-D20-C20-L250-Z02-H	●	20	2	20	250	150	10
new AEM90-AP10-D20.5-C20-L90-Z03	●	20.5	3	20	90	30	10
new AEM90-AP10-D21-C20-L150-Z03	●	21	3	20	200	35	10
AEM90-AP10-D21-C20-L200-Z03	●	21	3	20	200	30	10
new AEM90-AP10-D21-C20-L200-Z03-H	●	21	3	20	200	35	10
AEM90-AP10-D21-W20-L150-Z03	●	21	3	20	150	30	10
AEM90-AP10-D22-W20-L100-Z03-H	●	22	3	20	100	30	10
AEM90-AP10-D22-W20-L150-Z03	●	22	3	20	150	30	10
new AEM90-AP10-D22.5-W20-L150-Z03	●	22.5	3	20	150	30	10
AEM90-AP10-D23-W20-L150-Z03	●	23	3	20	150	30	10
AEM90-AP10-D24-W20-L150-Z03	●	24	3	20	150	30	10
AEM90-AP10-D25-W25-L100-Z04-H	●	25	4	25	100	30	10
new AEM90-AP10-D25-W25-L95-Z04-H	●	25	4	25	95	30	10
new AEM90-AP10-D25-W25-L150-Z04-H	●	25	4	25	150	50	10
AEM90-AP10-D25-C25-L100-Z03-H	●	25	3	25	100	30	10
AEM90-AP10-D25-W25-L100-Z03-H	●	25	3	25	100	30	10
AEM90-AP10-D25-C25-L120-Z03-H	●	25	3	25	120	30	10
AEM90-AP10-D25-C25-L150-Z03	●	25	3	25	150	50	10
AEM90-AP10-D25-W25-L150-Z03	●	25	3	25	150	50	10
AEM90-AP10-D25-C25-L200-Z02	●	25	2	25	200	100	10
AEM90-AP10-D25-C25-L200-Z03	●	25	3	25	200	100	10
AEM90-AP10-D25-C25-L250-Z02	●	25	2	25	250	100	10
new AEM90-AP10-D26-C25-L200-Z04	●	26	4	25	200	35	10

AP. 1003..

ISO UCUNA  
UYGUNDUR.  
FOR ISO INSERT.  
Kompatibel mit ISO

3008-M2.5x5

82-T08

3008-M2.5x6

R: Sağ / Right / Rechtsl L: Sol / Left / Links

● Stokta / In Stock / Auf Lager ○ Stokta Yok / Non Stock Item / Kein Lagerartikel, Lieferzeit auf Anfrage

Sipariş Örneği/Ordering Example/Bestellbeispiel

1 ad./pcs./stück AEM90-AP10-D16-C16-L150-Z02

Kesme Hesabı : S 377/ Cutting Calculation : P 377 / Schnittberechnung : P 377





# S-SİSTEM YÜZEY PARMAK FREZELER

S-SYSTEM END MILLS

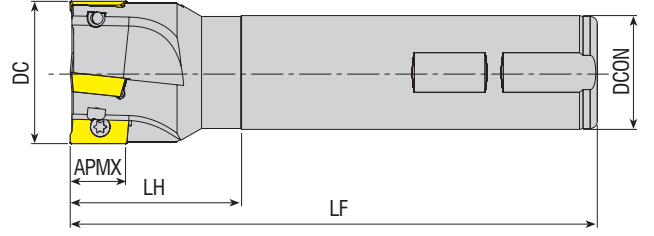
S-SYSTEM SCHAFTFRÄSER

KAPR=90°

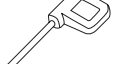

Takım Kodu Ordering Code Bestell-Bezeichnung	Stok Stock Lager	Takım Ölçüleri (mm) Dimension (mm) Abmessung (mm)						Kesici Uç Insert Wendeschneidplatte	Yedek Parçaları / Spare Parts / Ersatzteile				
		DC	ZEFP	DCON	LF	LH	APMX		Sıkma Vidası Screw Schraube	Tork Anahtar Torx Key Torx-Schlüssel			
AEM90-AP10-D30-C25-L100-Z04-H	●	30	4	25	100	30	10	 <b>AP. 1003..</b> ISO UCUNA UYGUNDUR. FOR ISO INSERT. Kompatibel mit ISO	 3008-M2.5x6				
AEM90-AP10-D30-C25-L120-Z04-H	●	30	4	25	120	30	10						
AEM90-AP10-D30-C25-L150-Z04	●	30	4	25	150	30	10						
AEM90-AP10-D32-C25-L100-Z04-H	●	32	4	25	100	35	10						
AEM90-AP10-D32-C25-L120-Z04-H	●	32	4	25	120	35	10						
AEM90-AP10-D32-C25-L150-Z04	●	32	4	25	150	35	10						
AEM90-AP10-D32-W25-L150-Z04	●	32	4	25	150	35	10						
<b>new</b> AEM90-AP10-D32-C32-L170-Z04	●	32	4	32	170	50	10						
<b>new</b> AEM90-AP10-D32-W25-L105-Z05-H	●	32	5	25	105	35	10						
AEM90-AP10-D32-C32-L130-Z05	●	32	5	32	130	30	10						
AEM90-AP10-D32-W32-L150-Z04	●	32	4	32	150	50	10						
AEM90-AP10-D40-W32-L150-Z05	●	40	5	32	150	40	10						
AEM90-AP10D-D16-W16-L150-Z02	●	16	2	16	150	50	10				 <b>AP. 1003..</b> DJT UCUNA UYGUNDUR. FOR DJT INSERT. Kompatibel mit DJT	3008-M2.5x5	82-T08
AEM90-AP10D-D20-W20-L150-Z03	●	20	3	20	150	50	10						
AEM90-AP10D-D25-W20-L150-Z03	●	25	3	20	150	30	10						
AEM90-AP100-D16-C15-L150-Z02	●	16	2	15	150	30	10						
AEM90-AP100-D21-C20-L150-Z03	●	21	3	20	150	30	10						
AEM90-AP100-D26-C25-L150-Z04	●	26	4	25	150	35	10						
AEM90-AP100-D33-C32-L200-Z05	●	33	5	32	200	50	10						
AEM90-AP10S-D16-W16-L150-Z02	●	16	2	16	150	26	10						
AEM90-AP10S-D20-W20-L150-Z02	●	20	2	20	150	26	10						
AEM90-AP10S-D25-W25-L150-Z03	●	25	3	25	150	26	10						
AEM90-AP11-D16-C16-L150-Z02	●	16	2	16	150	50	11	 <b>AP. 11T3..</b> ZCC UCUNA UYGUNDUR. FOR ZCC INSERT. Kompatibel mit ZCC Wendeplatten.	3008-M2.5x6	82-T08			
AEM90-AP11-D16-C16-L150-Z02-H	●	16	2	16	150	50	11						
AEM90-AP11-D16-W16-L150-Z02	●	16	2	16	150	50	11						
AEM90-AP11-D16-W16-L150-Z02-H	●	16	2	16	150	50	11						
AEM90-AP11-D16-C16-L200-Z02	●	16	2	16	200	100	11						
AEM90-AP11-D17-C16-L150-Z02	●	17	2	16	150	30	11						
AEM90-AP11-D17-C16-L200-Z02	●	17	2	16	200	30	11						
AEM90-AP11-D20-C20-L150-Z03	●	20	3	20	150	50	11						
AEM90-AP11-D20-W20-L150-Z03	●	20	3	20	150	50	11						
AEM90-AP11-D20-W20-L150-Z03-H	●	20	3	20	150	50	11						
AEM90-AP11-D20-C20-L200-Z03	●	20	3	20	200	100	11						
AEM90-AP11-D21-C20-L150-Z03	●	21	3	20	150	30	11						
AEM90-AP11-D21-W20-L150-Z03	●	21	3	20	150	30	11						
AEM90-AP11-D21-W20-L150-Z03-H	●	21	3	20	150	30	11						
AEM90-AP11-D21-C20-L200-Z03	●	21	3	20	200	30	11						
<b>new</b> AEM90-AP11-D22-C20-L180-Z03-H	●	22	3	20	180	30	11						
AEM90-AP11-D25-C25-L150-Z03	●	25	3	25	150	50	11						
AEM90-AP11-D25-W25-L150-Z03	●	25	3	25	150	50	11						
AEM90-AP11-D25-W25-L150-Z03-H	●	25	3	25	150	50	11						
AEM90-AP11-D26-C25-L150-Z03	●	26	3	25	150	35	11						
AEM90-AP11-D26-C24-L150-Z03	●	26	3	24	150	35	11						
<b>new</b> AEM90-AP11-D28-C25-L180-Z03-H	●	28	3	25	180	30	11						
AEM90-AP11-D32-W25-L150-Z04	●	32	4	25	150	35	11						
AEM90-AP11-D32-W32-L150-Z03-H	●	32	3	32	150	50	11						
AEM90-AP11-D32-W32-L150-Z04	●	32	4	32	150	50	11						

R: Sağ / Right / Rechts / L: Sol/Left/Links / ● Stokta / In Stock / Auf Lager ○ Stokta Yok / Non Stock Item / Kein Lagerartikel, Lieferzeit auf Anfrage

Sipariş Örneği/Ordering Example/Bestellbeispiel

1 ad./pcs./stück AEM90-AP10-D30-C25-L100-Z04-H

Kesme Hesabı : S 377/ Cutting Calculation : P 377 / Schnittberechnung : P 377



www.akkо.com.tr

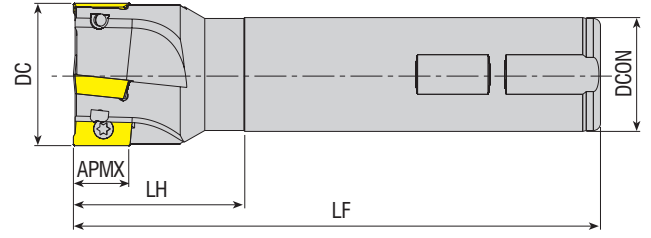
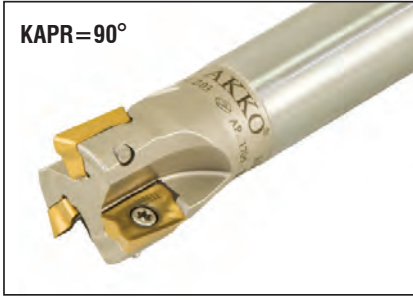

**Takım Kodu**  
**Ordering Code**  
**Bestell-Bezeichnung**

Stok  
Stock  
Lager

Takım Ölçüleri (mm)  
Dimension (mm)  
Abmessung (mm)

Kesici Uç  
Insert  
Wendeschneidplatte

Yedek Parçaları / Spare Parts / Ersatzteile

Sıkma Vidası  
Screw  
Schraube

Tork Anahtar  
Torx Key  
Torx-Schlüssel

	DC	ZEP	DCON	LF	LH	APMX
AEM90-AP1135A-D14-C16-L150-Z01	14	1	16	150	40	9.5
AEM90-AP1135A-D16-C16-L150-Z02	16	2	16	150	40	9.5
AEM90-AP1135A-D16-C16-L200-Z02	16	2	16	200	100	9.5
AEM90-AP1135A-D16-C16-L250-Z02	16	2	16	250	150	9.5
AEM90-AP1135A-D17-C16-L180-Z02	17	2	16	180	30	9.5
AEM90-AP1135A-D20-C20-L150-Z03	20	3	20	150	50	9.5
AEM90-AP1135A-D20-C20-L200-Z02	20	2	20	200	100	9.5
AEM90-AP1135A-D21-C20-L180-Z02	21	2	20	180	30	9.5
AEM90-AP1135A-D25-C25-L200-Z03	25	3	25	200	100	9.5
AEM90-AP1135A-D26-C25-L250-Z02	26	2	25	250	35	9.5
AEM90-AP1135A-D33-C32-L250-Z02	33	2	32	250	35	9.5
AEM90-AP110-D16-C15-L150-Z02	16	2	15	150	30	11
AEM90-AP110-D21-C20-L150-Z03	21	3	20	150	30	11
AEM90-AP110-D26-C25-L150-Z04	26	4	25	150	35	11
AEM90-AP110-D33-C32-L200-Z05	33	5	32	200	50	11
AEM90-APK11G-D16-W16-L150-Z02	16	2	16	150	26	11
AEM90-APK11G-D20-W20-L150-Z03	20	3	20	150	26	11
AEM90-APK11G-D25-W25-L150-Z03	25	3	25	150	26	11
AEM90-AP1135-D16-W16-L110-Z02-H	16	2	16	110	30	9.5
AEM90-AP1135-D16-W16-L150-Z02	16	2	16	150	50	9.5
AEM90-AP1135-D20-W20-L125-Z03-H	20	3	20	125	30	9.5
AEM90-AP1135-D20-W20-L150-Z03	20	3	20	150	50	9.5
AEM90-AP1135-D25-W25-L125-Z04-H	25	4	25	125	30	9.5
AEM90-AP1135-D25-W25-L200-Z04-H	25	4	25	200	100	9.5
AEM90-AP1135-D32-W32-L125-Z05-H	32	5	32	125	30	9.5
AEM90-AP1135-D32-W32-L200-Z04-H	32	4	32	200	100	9.5
AEM90-AP1135Y-D16-C16-L120-Z02-H	16	2	16	120	30	9.5
AEM90-AP1135Y-D16-W16-L150-Z02	16	2	16	150	50	9.5
AEM90-AP1135Y-D17-C16-L150-Z02	17	2	16	150	30	9.5
AEM90-AP1135Y-D20-C20-L120-Z02	20	2	20	120	30	9.5
AEM90-AP1135Y-D20-W20-L150-Z03	20	3	20	150	50	9.5
AEM90-AP1135Y-D21-C20-L150-Z03	21	3	20	150	30	9.5
AEM90-AP1135Y-D25-W25-L150-Z03	25	3	25	150	50	9.5
AEM90-AP1135Y-D25-C25-L150-Z04-H	25	4	25	150	30	9.5
AEM90-AP1135Y-D26-C25-L150-Z03	26	3	25	150	35	9.5
AEM90-AP1135Y-D32-W25-L110-Z04	32	4	25	110	35	9.5
AEM90-AP1204-D20-C20-L150-Z02	20	2	20	150	30	12
AEM90-AP1204-D21-C20-L150-Z02	21	2	20	150	30	12
AEM90-AP1204-D21-C20-L200-Z02	21	2	20	200	30	12
AEM90-AP1204-D22-C20-L200-Z02	22	2	20	200	30	12
AEM90-AP1204-D25-C25-L150-Z03	25	3	25	150	40	12
AEM90-AP1204-D25-C25-L250-Z03	25	3	25	250	40	12
AEM90-AP1204-D26-C25-L250-Z02	26	2	25	250	35	12
AEM90-AP1204-D32-C25-L150-Z03	32	3	25	150	35	12

**APMT 1135..**  
**ACHTK UCUNA UYGUNDUR.**  
FOR ACHTK INSERT.  
Kompatibel mit ACHTK

**AP. 1135..**  
**B.OKE UCUNA UYGUNDUR.**  
FOR B.OKE INSERT  
Kompatibel mit B.OKE

**APKT 1135..**  
**XTC-GSC UCUNA UYGUNDUR.**  
FOR XTC-GSC INSERT  
Kompatibel mit XTC-GSC

**AP. 1135..**  
**XTC-GSC UCUNA UYGUNDUR.**  
FOR XTC-GSC INSERT.  
Kompatibel mit XTC-GSC

**APMT 1135..**  
**YG UCUNA UYGUNDUR.**  
FOR YG INSERT.  
Kompatibel mit YG

**AP. 1204..**  
**TGTC UCUNA UYGUNDUR.**  
FOR TGTC INSERT.  
Kompatibel mit TGTC

3008-M2.5x5

3008-M2.5x6

3008-M2.5x5

3008-M2.5x6

3008-M3x5

3008-M3x6

3008-M2.5x6

3010-M3.5x7

3010-M3.5x9

82-T08

82-T10

new

new

R: Sağ / Right / Rechts L: Sol / Left / Links

● Stokta / In Stock / Auf Lager ○ Stokta Yok / Non Stock Item / Kein Lagerartikel, Lieferzeit auf Anfrage

Sipariş Örneği/Ordering Example/Bestellbeispiel

1 ad./pcs./stück AEM90-AP1135A-D14-C16-L150-Z01

Kesme Hesabı : S 377/ Cutting Calculation : P 377 / Schnittberechnung : P 377

# S-SİSTEM YÜZEY PARMAK FREZELER

S-SYSTEM END MILLS

S-SYSTEM SCHAFTFRÄSER

KAPR=90°

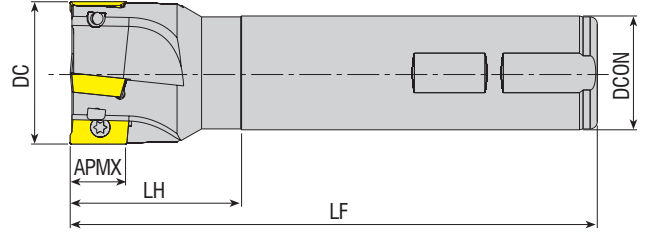
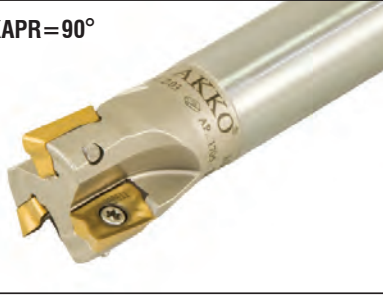

Takım Kodu Ordering Code Bestell-Bezeichnung	Stok Stock Lager	Takım Ölçüleri (mm) Dimension (mm) Abmessung (mm)						Kesici Uç Insert Wendeschneidplatte	Yedek Parçaları / Spare Parts / Ersatzteile		
		DC	ZEPF	DCON	LF	LH	APMX		Sıkma Vidası Screw Schraube	Tork Anahtar Torx Key Torx-Schlüssel	
AEM90-AP16-D25-C20-L100-Z02	●	25	2	20	100	35	16	AP. 1604.. ISO UCUNA UYGUNDUR. FOR ISO INSERT Kompatibel mit ISO	4015-M4x9	80-T15	
AEM90-AP16-D25-W25-L100-Z02-H	●	25	2	25	100	35	16				
AEM90-AP16-D25-W25-L150-Z02	●	25	2	25	150	50	16				
AEM90-AP16-D25-C25-L250-Z02	●	25	2	25	250	100	16				
AEM90-AP16-D28-W25-L100-Z03-H	●	28	3	25	100	40	16				
AEM90-AP16-D28-W25-L150-Z03	●	28	3	25	150	40	16				
AEM90-AP16-D30-W25-L110-Z03-H	●	30	3	25	110	40	16				
AEM90-AP16-D30-W25-L150-Z02	●	30	2	25	150	40	16				
AEM90-AP16-D30-W25-L150-Z03	●	30	3	25	150	40	16				
AEM90-AP16-D32-W32-L110-Z03-H	●	32	3	32	110	40	16				
AEM90-AP16-D32-C32-L150-Z03	●	32	3	32	150	50	16				
AEM90-AP16-D32-W25-L150-Z03	●	32	3	25	150	40	16				
AEM90-AP16-D32-W32-L150-Z03	●	32	3	32	150	50	16				
AEM90-AP16-D32-W32-L150-Z03-H	●	32	3	32	150	50	16				
AEM90-AP16-D32-C25-L200-Z03-H	●	32	3	25	200	40	16				
AEM90-AP16-D32-C32-L250-Z02	●	32	2	32	250	100	16				
AEM90-AP16-D32-C32-L250-Z03	●	32	3	32	250	100	16				
AEM90-AP16-D35-W32-L150-Z03	●	35	3	32	150	40	16				
AEM90-AP16-D36-W32-L110-Z03-H	●	36	3	32	110	40	16				
AEM90-AP16-D36-W32-L150-Z03	●	36	3	32	150	40	16				
AEM90-AP16-D40-W32-L110-Z04-H	●	40	4	32	110	40	16				
AEM90-AP16-D40-C32-L150-Z04	●	40	4	32	150	40	16				
AEM90-AP16-D40-W32-L150-Z04	●	40	4	32	150	40	16				
AEM90-AP16-D40-C32-L250-Z02	●	40	2	32	250	40	16				
AEM90-AP16-D40-C32-L250-Z04	●	40	4	32	250	40	16				
AEM90-AP16DJ-D25-W25-L150-Z02	●	25	2	25	150	50	16	AP. 1604.. DJT UCUNA UYGUNDUR. FOR DJT INSERT. Kompatibel mit DJT	4015-M4x9	80-T15	
AEM90-AP16DJ-D25-C25-L200-Z02	●	25	2	25	200	50	16				
AEM90-AP16DJ-D32-W32-L150-Z03	●	32	3	32	150	50	16				
AEM90-AP16DJ-D32-C32-L180-Z03	●	32	3	32	180	50	16				
AEM90-AP16DJ-D32-C32-L200-Z03	●	32	3	32	200	50	16				
AEM90-AP16L-D25-C25-L120-Z02-H	●	25	2	25	120	45	16	AP. 1604.. LMN UCUNA UYGUNDUR. FOR LMN INSERT. Kompatibel mit LMN	4015-M4x9	80-T15	
AEM90-AP16L-D25-C25-L150-Z02	●	25	2	25	150	55	16				
AEM90-AP16L-D25-C25-L200-Z02	●	25	2	25	200	55	16				
AEM90-AP16L-D25-C25-L250-Z02	●	25	2	25	250	100	16				
AEM90-AP16L-D30-W25-L120-Z03-H	●	30	3	25	120	40	16				
AEM90-AP16L-D32-C32-L120-Z03-H	●	32	3	32	120	45	16				
AEM90-AP16L-D32-C32-L150-Z03	●	32	3	32	150	55	16				
AEM90-AP16L-D32-C32-L200-Z03	●	32	3	32	200	55	16				
AEM90-AP16L-D32-C32-L250-Z03	●	32	3	32	250	100	16				
AEM90-AP16L-D36-W32-L130-Z03	●	36	3	32	130	40	16				
AEM90-AP16L-D40-C32-L120-Z04-H	●	40	4	32	120	40	16				
AEM90-AP16L-D40-C32-L150-Z04	●	40	4	32	150	40	16				
AEM90-AP16L-D40-C32-L200-Z04	●	40	4	32	200	40	16				
AEM90-AP16L-D40-C32-L250-Z04	●	40	4	32	250	40	16				

R: Sağ / Right / Rechts/ L: Sol / Left / Links

● Stokta / In Stock / Auf Lager ○ Stokta Yok / Non Stock Item / Kein Lagerartikel, Lieferzeit auf Anfrage

Sipariş Örneği/Ordering Example/Bestellbeispiel

1 ad./pcs./stück AEM90-AP16-D25-C20-L100-Z02

Kesme Hesabı : S 377/ Cutting Calculation : P 377 / Schnittberechnung : P 377



www.akkо.com.tr



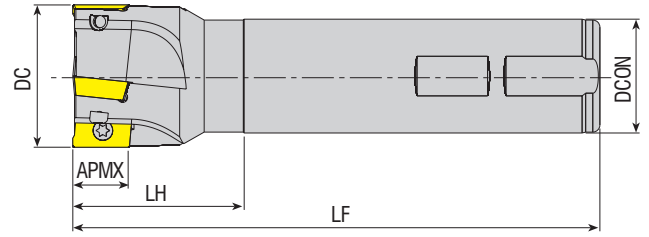
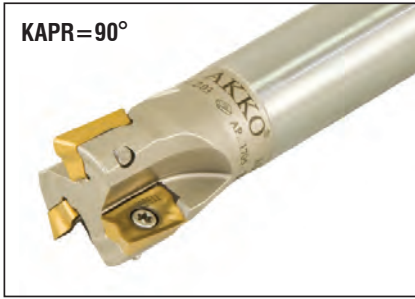

Takım Kodu Ordering Code Bestell-Bezeichnung	Stok Stock Lager	Takım Ölçüleri (mm) Dimension (mm) Abmessung (mm)						Kesici Uç Insert Wendeschneidplatte	Yedek Parçaları / Spare Parts / Ersatzteile	
		DC	ZEFP	DCON	LF	LH	APMX		Sıkma Vidası Screw Schraube	Tork Anahtar Torx Key Torx-Schlüssel
AEM90-AP16P-D25-W25-L100-Z02-H	●	25	2	25	100	35	16	AP. 1604.. PLBT UCUNA UYGUNDUR. FOR PLBT INSERT. Kompatibel mit PLBT	4015-M4x9	80-T15
AEM90-AP16P-D25-W25-L150-Z02	●	25	2	25	150	50	16			
AEM90-AP16P-D32-W32-L150-Z03	●	32	3	32	150	50	16			
AEM90-AP16P-D32-C32-L250-Z02	●	32	2	32	250	100	16			
AEM90-AP16P-D40-W32-L150-Z04	●	40	4	32	150	50	16	AP. 1604.. YG UCUNA UYGUNDUR. FOR YG INSERT. Kompatibel mit YG	4015-M4x9	80-T15
AEM90-AP16Y-D25-C20-L100-Z02-H	●	25	2	20	100	35	16			
AEM90-AP16Y-D25-C25-L120-Z02	●	25	2	25	120	50	16			
AEM90-AP16Y-D25-C25-L150-Z02	●	25	2	25	150	50	16			
AEM90-AP16Y-D25-C25-L250-Z02	●	25	2	25	250	100	16	AP. 1705.. TGTC-LMN UCUNA UYGUNDUR. FOR TGTC-LMN INSERT. Kompatibel mit TGTC-LMN	4015-M4x9	80-T15
AEM90-AP1705-D25-C25-L120-Z02	●	25	2	25	120	40	16			
AEM90-AP1705-D26-C25-L200-Z02	●	26	2	25	200	40	16			
AEM90-AP1705-D26-C25-L250-Z02	●	26	2	25	250	40	16			
AEM90-AP1705-D26-C25-L300-Z02	○	26	2	25	300	40	16	AP. 1705.. TGTC-LMN UCUNA UYGUNDUR. FOR TGTC-LMN INSERT. Kompatibel mit TGTC-LMN	4015-M4x9	80-T15
AEM90-AP1705-D28-W25-L075-Z02	●	28	2	25	75	20	16			
AEM90-AP1705-D32-C25-L150-Z03	●	32	3	25	150	40	16			
AEM90-AP1705-D33-C32-L250-Z03	●	33	3	32	250	40	16			
AEM90-AP1705-D33-C32-L300-Z02	●	33	2	32	300	40	16			

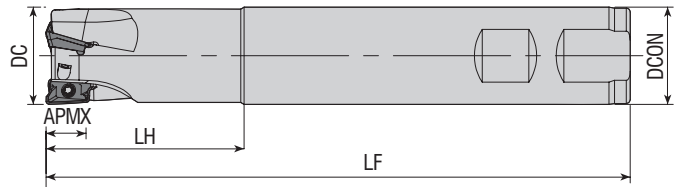

Takım Kodu Ordering Code Bestell-Bezeichnung	Stok Stock Lager	Takım Ölçüleri (mm) Dimension (mm) Abmessung (mm)						Kesici Uç Insert Wendeschneidplatte	Yedek Parçaları / Spare Parts / Ersatzteile	
		DC	ZEFP	DCON	LF	LH	APMX		Sıkma Vidası Screw Schraube	Tork Anahtar Torx Key Torx-Schlüssel
AEM90-A01236-D16-W16-L150-Z02	●	16	2	16	150	50	10	A0.1236..	3008-M2.5x6	82-T08
new AEM90-A01236-D16-C16-L160-Z02-H	●	16	2	16	160	25	10			
new AEM90-A01236-D17-C16-L150-Z02-H	●	17	2	16	150	25	10			
new AEM90-A01236-D18-C16-L160-Z02-H	●	18	2	16	160	25	10			
new AEM90-A01236-D20-C20-L160-Z03-H	●	20	3	20	160	30	10			
AEM90-A01236-D20-C20-L100-Z02	●	20	2	20	100	30	10			
new AEM90-A01236-D21-C20-L220-Z03-H	●	21	3	20	220	30	10			
new AEM90-A01236-D22-C20-L160-Z03-H	●	22	3	20	160	30	10			
AEM90-A01236-D25-C25-L115-Z02	●	25	2	25	150	50	10			
new AEM90-A01236-D25-C25-L160-Z04-H	●	25	4	25	160	50	10			
AEM90-A01236-D25-W25-L150-Z03	●	25	3	25	150	50	10			
new AEM90-A01236-D26-C25-L150-Z04-H	●	26	4	25	150	35	10			
new AEM90-A01236-D26-C25-L160-Z04-H	●	26	4	25	160	35	10			
AEM90-A01236-D32-W32-L150-Z04	●	32	4	32	150	50	10			
new AEM90-A01236-D32-C32-L160-Z05-H	●	32	5	32	160	50	10			

R: Sağ / Right / Rechtsl L: Sol / Left / Links  
● Stokta / In Stock / Auf Lager ○ Stokta Yok / Non Stock Item / Kein Lagerartikel, Lieferzeit auf Anfrage  
MTSBH Ucuna Uygundur. / Compatible with MTSBH Insert. / Kompatibel mit MTSBH Wendeplatten.

Sipariş Örneği/Ordering Example/Bestellbeispiel  
1 ad./pcs./stück AEM90-AP16P-D25-W25-L100-Z02-H  
Kesme Hesabı : S 367 / Cutting Calculation : P 367 / Schnittberechnung : P 367

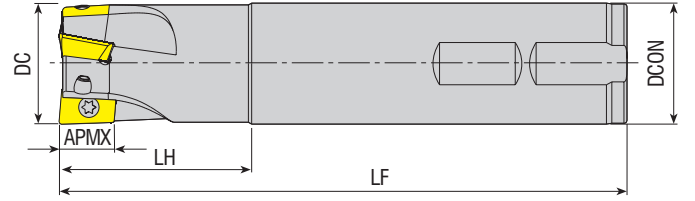

Takım Kodu Ordering Code Bestell-Bezeichnung	Stok Stock Lager	Takım Ölçüleri (mm) Dimension (mm) Abmessung (mm)						Kesici Uç Insert Wendeschneidplatte	Yedek Parçaları / Spare Parts / Ersatzteile	
		DC	ZEFP	DCON	LF	LH	APMX		Sıkma Vidası Screw Schraube	Tork Anahtar Torx Key Torx-Schlüssel
AEM90-AX0602-D10-C09-L120-Z02	●	10	2	9	120	20	5.7	AX.. 0602	3006-M1.8x4	82-T06
AEM90-AX0602-D10-C10-L080-Z02	●	10	2	10	80	20	5.7			
AEM90-AX0602-D10-C10-L120-Z02	●	10	2	10	120	20	5.7			
AEM90-AX0602-D12-C11-L120-Z02	●	12	2	11	120	20	5.7			
AEM90-AX0602-D12-C12-L080-Z02	●	12	2	12	80	20	5.7			
AEM90-AX0602-D12-C12-L120-Z02	●	12	2	12	120	20	5.7			
AEM90-AX0602-D14-C12-L120-Z03	●	14	3	12	120	20	5.7			
AEM90-AX0602-D16-W16-L120-Z04-H	●	16	4	16	120	20	5.7			
AEM90-AX0602-D16-W16-L150-Z04-H	●	16	4	16	150	20	5.7			
AEM90-AX0602-D20-W20-L120-Z05-H	●	20	5	20	120	25	5.7			
AEM90-AX0602-D20-W20-L150-Z05-H	●	20	5	20	150	25	5.7			
AEM90-AX0903-D16-C16-L120-Z02	●	16	2	16	120	30	8.8			
AEM90-AX0903-D16-C16-L180-Z02	●	16	2	16	180	30	8.8			
AEM90-AX0903-D17-C16-L120-Z02	●	17	2	16	120	25	8.8			
AEM90-AX0903-D17-C16-L180-Z02	●	17	2	16	180	25	8.8			
AEM90-AX0903-D20-C20-L120-Z03	●	20	3	20	120	30	8.8			
AEM90-AX0903-D20-C20-L200-Z02	●	20	2	20	200	30	8.8			
AEM90-AX0903-D21-C20-L120-Z03	●	21	3	20	120	25	8.8			
AEM90-AX0903-D21-C20-L200-Z02	●	21	2	20	200	25	8.8			
AEM90-AX0903-D25-C25-L150-Z03	●	25	3	25	150	30	8.8			
AEM90-AX0903-D25-C25-L250-Z02	●	25	2	25	250	40	8.8			
AEM90-AX0903-D26-C25-L150-Z03	●	26	3	25	150	30	8.8			

R: Sağ / Right / Rechts/ L: Sol / Left / Links

● Stokta / In Stock / Auf Lager ○ Stokta Yok / Non Stock Item / Kein Lagerartikel, Lieferzeit auf Anfrage  
TGTC Ucuına Uyğundur. / Compatible with TGTC Insert. / Kompatibel mit TGTC Wendeplatten.

Sipariş Örneği/Ordering Example/Bestellbeispiel

1 ad./pcs./stück AEM90-AX0602-D10-C09-L120-Z02

Kesme Hesabı : S 377/ Cutting Calculation : P 377 / Schnittberechnung : P 377



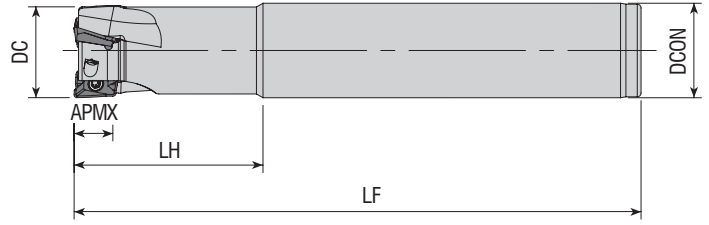

Takım Kodu Ordering Code Bestell-Bezeichnung	Stok Stock Lager	Takım Ölçüleri (mm) Dimension (mm) Abmessung (mm)						Kesici Uç Insert Wendeschneidplatte	Yedek Parçaları / Spare Parts / Ersatzteile			
		DC	ZEFP	DCON	LF	LH	APMX		Sıkma Vidası Screw Schraube	Tork Anahtar Torx Key Torx-Schlüssel		
AEM90-AX1235-D16-C14-L120-Z02-H	●	16	2	14	120	25	10	AX.T 1235..	3008-M3x6	82-T08		
AEM90-AX1235-D16-C15-L145-Z02-H	●	16	2	15	145	30	10		3108-M3x6			
AEM90-AX1235-D16-C16-L100-Z02-H	●	16	2	16	100	30	10		3008-M3x6			
AEM90-AX1235-D16-C16-L140-Z02-H	●	16	2	16	140	30	10		3108-M3x6			
AEM90-AX1235-D16-C16-L145-Z02-H	●	16	2	16	145	30	10		3008-M3x6			
AEM90-AX1235-D16-C16-L150-Z02	●	16	2	16	150	30	10		3108-M3x6			
AEM90-AX1235-D20-C19-L150-Z02-H	●	20	2	19	150	40	10		3008-M3x6			
AEM90-AX1235-D20-C20-L110-Z03-H	●	20	3	20	110	40	10		3108-M3x6			
AEM90-AX1235-D20-C20-L150-Z02	●	20	2	20	150	40	10		3008-M3x6			
AEM90-AX1235-D20-C20-L150-Z02-H	●	20	2	20	150	40	10		3108-M3x6			
AEM90-AX1235-D20-C20-L150-Z03	●	20	3	20	150	40	10		3008-M3x6			
AEM90-AX1235-D25-C20-L120-Z04-H	●	25	4	20	120	30	10		3108-M3x6			
AEM90-AX1235-D25-C20-L150-Z04-H	●	25	4	20	150	30	10		3008-M3x6			
AEM90-AX1235-D25-C24-L170-Z02-H	●	25	2	24	170	50	10		3108-M3x6			
AEM90-AX1235-D25-C25-L120-Z04-H	●	25	4	25	120	40	10		3008-M3x6			
AEM90-AX1235-D25-C25-L150-Z03	●	25	3	25	150	50	10		3108-M3x6			
AEM90-AX1235-D25-C25-L170-Z02-H	●	25	2	25	170	50	10		3008-M3x6			
AEM90-AX1235-D25-W25-L100-Z04-H	●	25	4	25	100	30	10		3108-M3x6			
AEM90-AX1235-D32-C32-L130-Z05-H	●	32	5	32	130	40	10		AX.T 1705..		4015-M4x9	80-T15
AEM90-AX1235-D32-C32-L180-Z02-H	●	32	2	32	180	50	10					
AEM90-AX1705-D25-C25-L150-Z02	●	25	2	25	150	50	14					
AEM90-AX1705-D28-W25-L115-Z02-H	●	28	2	25	115	35	14					
AEM90-AX1705-D32-C32-L150-Z03	●	32	3	32	150	50	14					
AEM90-AX1705-D32-C32-L180-Z02-H	●	32	2	32	180	50	14					



R: Sağ / Right / Rechts/ L: Sol / Left / Links

● Stokta / In Stock / Auf Lager ○ Stokta Yok / Non Stock Item / Kein Lagerartikel, Lieferzeit auf Anfrage  
SMTM Ucuna Uygunudur. / Compatible with SMTM Insert / Kompatibel mit SMTM Wendepplatten.

Sipariş Örneği/Ordering Example/Bestellbeispiel  
1 ad./pcs./stück AEM90-AX1235-D16-C14-L120-Z02-H  
Kesme Hesabı : S 377/ Cutting Calculation : P 377 / Schnittberechnung : P 377

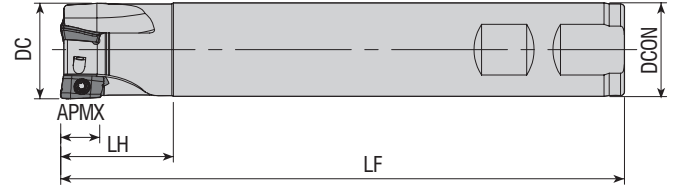
KAPR=90°



Takım Kodu Ordering Code Bestell-Bezeichnung	Stok Stock Lager	Takım Ölçüleri (mm) Dimension (mm) Abmessung (mm)						Kesici Uç Insert Wendeschneidplatte	Yedek Parçaları / Spare Parts / Ersatzteile		
		DC	ZEFP	DCON	LF	LH	APMX		Sıkma Vidası Screw Schraube	Tork Anahtar Torx Key Torx-Schlüssel	
AEM90-AZ11-D12-W16-L90-Z01	●	12	1	16	90	30	11				
AEM90-AZ11-D16-C16-L200-Z02	●	16	2	16	200	100	11				
AEM90-AZ11-D16-W15-L170-Z02	●	16	2	15	170	50	11				
AEM90-AZ11-D16-W16-L100-Z02	●	16	2	16	100	35	11				
AEM90-AZ11-D16-W16-L150-Z02	●	16	2	16	150	50	11				
AEM90-AZ11-D17-C16-L150-Z02	●	17	2	16	150	30	11				
AEM90-AZ11-D17-C16-L180-Z02	●	17	2	16	180	50	11				
AEM90-AZ11-D17-W16-L100-Z02	●	17	2	16	100	30	11				
AEM90-AZ11-D18-W16-L120-Z02	●	18	2	16	120	18	11		AZGT 1135..	3008-M2.5X6	82-T08
AEM90-AZ11-D20-C20-L200-Z03	●	20	3	20	200	100	11				
AEM90-AZ11-D20-W19-L170-Z03	●	20	3	19	170	50	11				
AEM90-AZ11-D20-W20-L110-Z02	●	20	2	20	110	35	11				
AEM90-AZ11-D21-C20-L150-Z03	●	21	3	20	150	30	11				
AEM90-AZ11-D21-C20-L180-Z03	●	21	3	20	180	50	11				
AEM90-AZ11-D21-W20-L110-Z03	●	21	3	20	110	35	11				
AEM90-AZ11-D22-C20-L150-Z02	●	22	2	20	150	30	11				
AEM90-AZ11-D25-C24-L180-Z04	●	25	4	24	180	50	11				
AEM90-AZ11-D25-W25-L110-Z04	●	25	4	25	110	40	11				
AEM90-AZ11-D26-C25-L250-Z02	●	26	2	25	250	50	11				
AEM90-AZ11-D26-W25-L120-Z03	●	26	3	25	120	30	11				
AEM90-AZ11-D26-W25-L120-Z04	●	26	4	25	120	40	11				
AEM90-AZ11-D28-C25-L180-Z03	●	28	3	25	180	50	11				
AEM90-AZ11-D28-C25-L250-Z02	●	28	2	25	250	50	11				
AEM90-AZ11-D33-W32-L130-Z04	●	33	4	32	130	50	11				

R: Sağ / Right / Rechtsl L: Sol / Left / Links

● Stokta / In Stock / Auf Lager ○ Stokta Yok / Non Stock Item / Kein Lagerartikel, Lieferzeit auf Anfrage  
ZCC Ucuna Uygunudur. / Compatible with ZCC Insert. / Kompatibel mit ZCC Wendeplatten.

Sipariş Örneği/Ordering Example/Bestellbeispiel

1 ad./pcs./stück AEM90-AZ11-D12-W16-L90-Z01

Kesme Hesabı : S 377/ Cutting Calculation : P 377 / Schnittberechnung : P 377

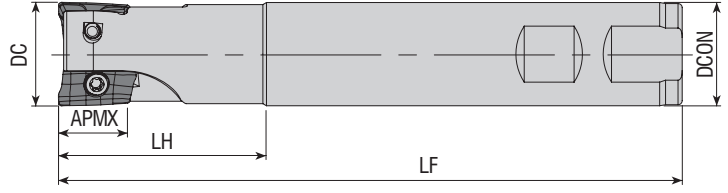

**Takım Kodu**  
**Ordering Code**  
**Bestell-Bezeichnung**

Stok  
Stock  
Lager

Takım Ölçüleri (mm)  
Dimension (mm)  
Abmessung (mm)

Kesici Uç  
Insert  
Wendeschneidplatte

Yedek Parçaları / Spare Parts / Ersatzteile

Sıkma Vidası  
Screw  
Schraube

Tork Anahtar  
Torx Key  
Torx-Schlüssel

Takım Kodu	Stok	DC	ZEFP	DCON	LF	LH	APMX	Kesici Uç	Sıkma Vidası	Tork Anahtar
AEM90-BD11T3-D16-C16-L100-Z02-H	●	16	2	16	100	30	10	BDMT 11T3..	3008-M2.5x5	82-T08
AEM90-BD11T3-D16-W16-L100-Z02-H	●	16	2	16	100	30	10			
AEM90-BD11T3-D16-W16-L150-Z02	●	16	2	16	150	50	10			
AEM90-BD11T3-D16-C16-L160-Z02-H	●	16	2	16	160	60	10			
AEM90-BD11T3-D16-C15-L180-Z02	●	16	2	15	180	50	10			
AEM90-BD11T3-D17-W16-L150-Z02	●	17	2	16	150	25	10			
AEM90-BD11T3-D17-C16-L180-Z02	●	17	2	16	180	25	10			
AEM90-BD11T3-D18-W16-L100-Z02	●	18	2	16	100	25	10			
AEM90-BD11T3-D18-W16-L100-Z02-H	●	18	2	16	100	25	10			
new AEM90-BD11T3-D20-W16-L61-Z03	●	20	3	16	61	26	10			
AEM90-BD11T3-D20-W20-L81-Z03-H	●	20	3	20	81	30	10			
AEM90-BD11T3-D20-W20-L100-Z02-H	●	20	2	20	100	30	10			
AEM90-BD11T3-D20-W20-L100-Z03-H	●	20	3	20	100	30	10			
AEM90-BD11T3-D20-C20-L110-Z03-H	●	20	3	20	110	30	10			
AEM90-BD11T3-D20-W20-L150-Z02	●	20	2	20	150	50	10			
AEM90-BD11T3-D20-W20-L150-Z03	●	20	3	20	150	50	10			
AEM90-BD11T3-D20-W20-L150-Z03-H	●	20	3	20	150	50	10			
AEM90-BD11T3-D20-C20-L170-Z03-H	●	20	3	20	170	60	10			
AEM90-BD11T3-D21-W20-L150-Z03	●	21	3	20	150	25	10			
AEM90-BD11T3-D21-C20-L200-Z02	●	21	2	20	200	25	10			
new AEM90-BD11T3-D22-W20-L090-Z02-H	●	22	2	20	90	25	10			
AEM90-BD11T3-D22-W20-L100-Z03-H	●	22	3	20	100	30	10			
AEM90-BD11T3-D25-W25-L100-Z03-H	●	25	3	25	100	30	10			
AEM90-BD11T3-D25-C20-L120-Z03-H	●	25	3	20	120	30	10			
AEM90-BD11T3-D25-C25-L120-Z03-H	●	25	3	25	120	30	10			
AEM90-BD11T3-D25-W25-L150-Z03	●	25	3	25	150	50	10			
AEM90-BD11T3-D26-W25-L150-Z03	●	26	3	25	150	35	10			
AEM90-BD11T3-D26-C25-L250-Z02	●	26	2	25	250	35	10			
AEM90-BD11T3-D32-W32-L110-Z04-H	●	32	4	32	110	40	10			
AEM90-BD11T3-D32-C32-L130-Z04-H	●	32	4	32	130	40	10			
AEM90-BD11T3-D32-W32-L150-Z04	●	32	4	32	150	50	10			
AEM90-BD11T3-D40-W32-L110-Z04-H	●	40	4	32	110	35	10			
AEM90-BD1704-D25-W25-L100-Z02-H	●	25	2	25	100	35	15.7	BDMT 1704..	4015-M4x8	80-T15
AEM90-BD1704-D25-W25-L150-Z02	●	25	2	25	150	50	15.7			
AEM90-BD1704-D25-C25-L210-Z02-H	●	25	2	25	210	100	15.7			
AEM90-BD1704-D32-W32-L110-Z03-H	●	32	3	32	110	40	15.7			
AEM90-BD1704-D32-C32-L130-Z03-H	●	32	3	32	130	40	15.7			
AEM90-BD1704-D32-W32-L130-Z03-H	●	32	3	32	130	40	15.7			
AEM90-BD1704-D32-W32-L150-Z03	●	32	3	32	150	50	15.7			
AEM90-BD1704-D40-W32-L110-Z04-H	●	40	4	32	110	40	15.7			
AEM90-BD1704-D40-W32-L150-Z04	●	40	4	32	150	40	15.7			

R: Sağ / Right / Rechts/ L: Sol / Left / Links

● Stokta / In Stock / Auf Lager ○ Stokta Yok / Non Stock Item / Kein Lagerartikel, Lieferzeit auf Anfrage

KYCR Ucuna Uygunudur. / Compatible with KYCR Insert. / Kompatibel mit KYCR Wendeplatten.

Sipariş Örneği/Ordering Example/Bestellbeispiel

1 ad./pcs./stück AEM90-BD11T3-D16-C16-L100-Z02-H

Kesme Hesabı : S 367 / Cutting Calculation : P 367 / Schnittberechnung : P 367

## S-SİSTEM YÜZEY PARMAK FREZELER

S-SYSTEM END MILLS

S-SYSTEM SCHAFTFRÄSER

KAPR=90°

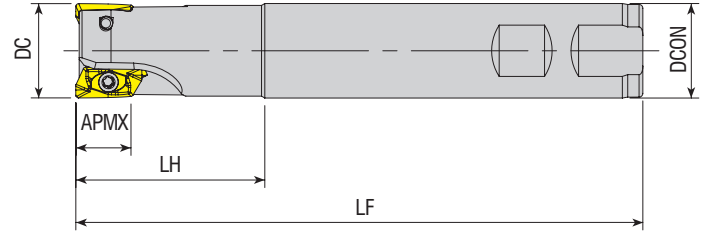

Takım Kodu Ordering Code Bestell-Bezeichnung	Stok Stock Lager	Takım Ölçüleri (mm) Dimension (mm) Abmessung (mm)						Kesici Uç Insert Wendeschneidplatte	Yedek Parçaları / Spare Parts / Ersatzteile	
		DC	ZEFP	DCON	LF	LH	APMX		Sıkma Vidası Screw Schraube	Tork Anahtar Torx Key Torx-Schlüssel
AEM90-ED10T3-D16-W16-L120-Z02	●	16	2	16	120	30	30	EDPT 10T3..	3008-M2.5x5	82-T08
AEM90-ED10T3-D20-W20-L120-Z02	●	20	2	20	120	30	30		3008-M2.5x6	
AEM90-ED1404-D20-W20-L150-Z02	●	20	2	20	150	50	14.5	EDPT 1404..	3008-M3x6	
AEM90-ED1404-D25-W25-L150-Z02	●	25	2	25	150	50	14.5			
AEM90-ED1404-D30-C25-L150-Z03	●	30	3	25	150	50	14.5			

KNMTL Ucuna Uygundur. / Compatible with KNMTL Insert. / Kompatibel mit KNMTL

KAPR=90°

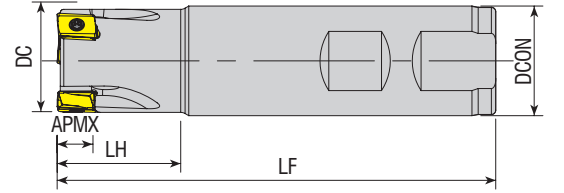

Takım Kodu Ordering Code Bestell-Bezeichnung	Stok Stock Lager	Takım Ölçüleri (mm) Dimension (mm) Abmessung (mm)						Kesici Uç Insert Wendeschneidplatte	Yedek Parçaları / Spare Parts / Ersatzteile	
		DC	ZEFP	DCON	LF	LH	APMX		Sıkma Vidası Screw Schraube	Tork Anahtar Torx Key Torx-Schlüssel
AEM90-LN08-D16-W16-L100-Z02-H	●	16	2	16	100	28	8	LNMT 0804..	1707-U4-48x6	82-T07
AEM90-LN08-D16-W16-L150-Z02	●	16	2	16	150	40	8		1707-U4-48x6.5	
AEM90-LN08-D20-W20-L100-Z03-H	●	20	3	20	100	28	8		1707-U4-48x8.2	
AEM90-LN08-D25-W25-L100-Z03-H	●	25	3	25	100	30	8			
AEM90-LN08-D32-W32-L110-Z05-H	●	32	5	32	110	30	8			
<b>new</b> AEM90-LN1306-D32-W32-L150-Z03	●	32	3	32	150	50	12.5	LNMT 1306..	4015-M4x11	80-T15
<b>new</b> AEM90-LN1306-D36-C32-L110-Z03-H	●	36	3	32	110	40	12.5			

R: Sağ / Right / Rechts/ L: Sol / Left / Links

● Stokta / In Stock / Auf Lager ○ Stokta Yok / Non Stock Item / Kein Lagerartikel, Lieferzeit auf Anfrage  
ISCR Ucuna Uygundur. / Compatible with ISCR Insert. / Kompatibel mit ISCR Wendeplatten.

Sipariş Örneği/Ordering Example/Bestellbeispiel

1 ad./pcs./stück AEM90-ED10T3-D16-W16-L120-Z02

Kesme Hesabı : S 377/ Cutting Calculation : P 377 / Schnittberechnung : P 377



www.akko.com.tr

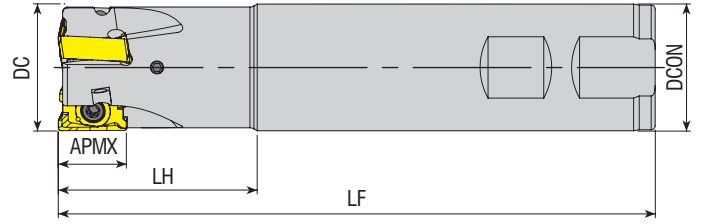

Takım Kodu Ordering Code Bestell-Bezeichnung	Stok Stock Lager	Takım Ölçüleri (mm) Dimension (mm) Abmessung (mm)						Kesici Uç Insert Wendeschneidplatte	Yedek Parçaları / Spare Parts / Ersatzteile		
		DC	ZEFP	DCON	LF	LH	APMX		Sıkma Vidası Screw Schraube	Tork Anahtar Torx Key Torx-Schlüssel	
AEM90-LN15T6-D25-W25-L150-Z02-H	●	25	2	25	150	50	15.5	LNGU 15T6..	4015-M4x12	80-T15	
AEM90-LN15T6-D32-W32-L150-Z03-H	●	32	3	32	150	50	15.5				
AEM90-LN15T6-D40-W32-L150-Z03-H	●	40	3	32	150	40	15.5				

KNMTL Ucuna Uygunur. / Compatible with KNMTL Insert. / Kompatibel mit KNMTL Wendeplatten.

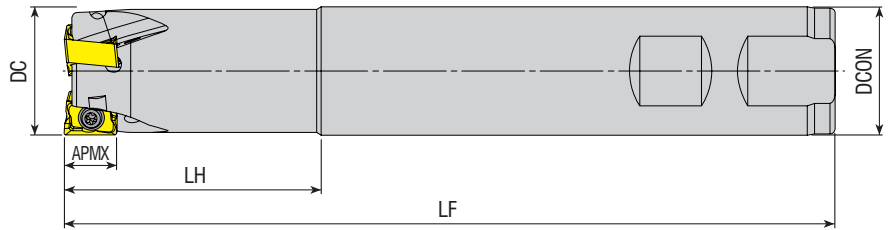

Takım Kodu Ordering Code Bestell-Bezeichnung	Stok Stock Lager	Takım Ölçüleri (mm) Dimension (mm) Abmessung (mm)						Kesici Uç Insert Wendeschneidplatte	Yedek Parçaları / Spare Parts / Ersatzteile		
		DC	ZEFP	DCON	LF	LH	APMX		Sıkma Vidası Screw Schraube	Tork Anahtar Torx Key Torx-Schlüssel	
AEM90-LN1006-D16-W16-L120-Z01-H	●	16	1	16	120	30	9	LN.X 1006..	4010-M3x8	82-T10	
AEM90-LN1006-D16-W16-L150-Z01	●	16	1	16	150	50	9				
AEM90-LN1006-D18-W16-L120-Z02-H	●	18	2	16	120	30	9				
AEM90-LN1006-D20-W20-L120-Z02-H	●	20	2	20	120	30	9				
AEM90-LN1006-D20-W20-L150-Z02	●	20	2	20	150	50	9				
AEM90-LN1006-D25-W25-L120-Z03-H	●	25	3	25	120	30	9				
AEM90-LN1006-D25-W25-L150-Z03	●	25	3	25	150	50	9				
AEM90-LN1006-D32-W32-L120-Z04-H	●	32	4	32	120	30	9				
AEM90-LN1006-D32-W32-L150-Z04	●	32	4	32	150	50	9				

R: Sağ / Right / Rechts/ L: Sol / Left / Links  
● Stokta / In Stock / Auf Lager ○ Stokta Yok / Non Stock Item / Kein Lagerartikel, Lieferzeit auf Anfrage  
KRYL Ucuna Uygunur. / Compatible with KRYL Insert. / Kompatibel mit KRYL Wendeplatten.

Sipariş Örneği/Ordering Example/Bestellbeispiel  
1 ad./pcs./stück AEM90-LN15T6-D25-W25-L150-Z02-H  
Kesme Hesabı : S 377/ Cutting Calculation : P 377 / Schnittberechnung : P 377

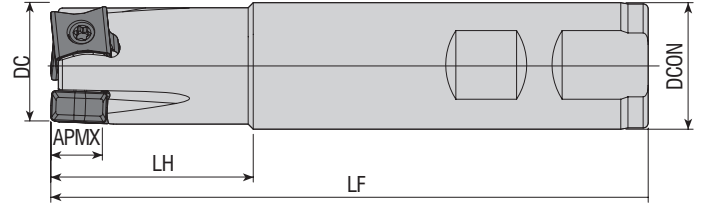

Takım Kodu Ordering Code Bestell-Bezeichnung	Stok Stock Lager	Takım Ölçüleri (mm) Dimension (mm) Abmessung (mm)						Kesici Uç Insert Wendeschneidplatte	Yedek Parçaları / Spare Parts / Ersatzteile	
		DC	ZEFP	DCON	LF	LH	APMX		Sıkma Vidası Screw Schraube	Tork Anahtar Torx Key Torx-Schlüssel
AEM90-LN1106-D25-W25-L150-Z03	●	25	3	25	150	40	10	LNMT 1106..	4015-M3.5x11	80-T15
AEM90-LN1106-D32-W32-L150-Z04	●	32	4	32	150	40	10			
AEM90-LN1106-D40-W32-L150-Z05	●	40	5	32	150	40	10			

ISCR-XTC-GSC Ucuna Uygunudur. / Compatible with ISCR-XTC-GSC Insert. / Kompatibel mit ISCR-XTC-GSC Wendepfetten.

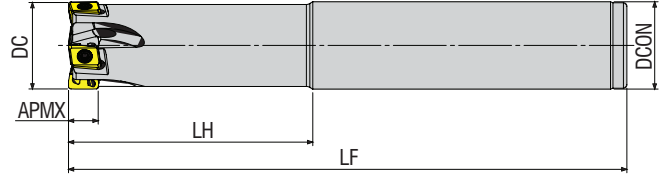

Takım Kodu Ordering Code Bestell-Bezeichnung	Stok Stock Lager	Takım Ölçüleri (mm) Dimension (mm) Abmessung (mm)						Kesici Uç Insert Wendeschneidplatte	Yedek Parçaları / Spare Parts / Ersatzteile	
		DC	ZEFP	DCON	LF	LH	APMX		Sıkma Vidası Screw Schraube	Tork Anahtar Torx Key Torx-Schlüssel
AEM90-L009-D16-C16-L160-Z02-H	○	16	2	16	160	60	8	LOGU 0904..	1110-M3x8.5	82-T08
AEM90-L009-D18-C16-L160-Z02-H	○	18	2	16	160	25	8			
AEM90-L009-D20-C20-L160-Z03-H	○	20	3	20	160	60	8			
AEM90-L009-D20-W20-L100-Z03-H	●	20	3	20	100	30	8			
AEM90-L009-D22-C20-L160-Z03-H	○	22	3	20	160	30	8			
AEM90-L009-D25-C25-L160-Z04-H	○	25	4	25	160	70	8			
AEM90-L009-D25-W25-L091-Z03-H	●	25	3	25	91	30	8			
AEM90-L009-D32-C32-L160-Z05-H	●	32	5	32	160	70	8			

R: Sağ / Right / Rechtsl L: Sol / Left / Links  
● Stokta / In Stock / Auf Lager ○ Stokta Yok / Non Stock Item / Kein Lagerartikel, Lieferzeit auf Anfrage  
MTSBH Ucuna Uygunudur. / Compatible with MTSBH Insert. / Kompatibel mit MTSBH Wendepfetten.

Sipariş Örneği/Ordering Example/Bestellbeispiel  
1 ad./pcs./stück AEM90-LN1106-D25-W25-L150-Z03  
Kesme Hesabı : S 377 / Cutting Calculation : P 377 / Schnittberechnung : P 377





KAPR=90°

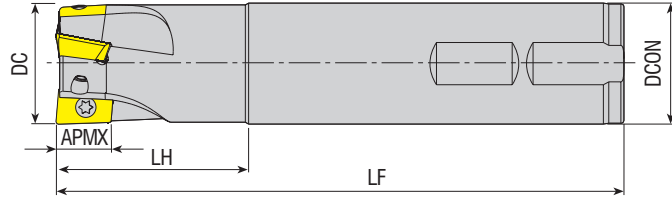

Takım Kodu Ordering Code Bestell-Bezeichnung	Stok Stock Lager	Takım Ölçüleri (mm) Dimension (mm) Abmessung (mm)						Kesici Uç Insert Wendeschneidplatte	Yedek Parçaları / Spare Parts / Ersatzteile		
		DC	ZEFP	DCON	LF	LH	APMX		Sıkma Vidası Screw Schraube	Tork Anahtar Torx Key Torx-Schlüssel	
AEM90-L010-D16-W16-L100-Z02	●	16	2	16	100	30	10	LOMU 1004..		1108-M3x6	
AEM90-L010-D16-W16-L160-Z02	●	16	2	16	160	50	10				
AEM90-L010-D20-W20-L130-Z03	●	20	3	20	130	40	10				
AEM90-L010-D25-W25-L150-Z03	●	25	3	25	150	50	10				
AEM90-L010-D32-W32-L150-Z04	●	32	4	32	150	50	10				

KYCR Ucuna Uygundur. / Compatible with KYCR Insert. / Kompatibel mit KYCR Wendeplatten.

KAPR=90°

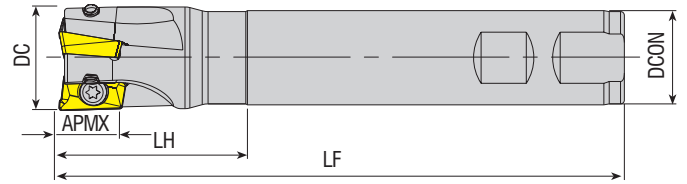

Takım Kodu Ordering Code Bestell-Bezeichnung	Stok Stock Lager	Takım Ölçüleri (mm) Dimension (mm) Abmessung (mm)						Kesici Uç Insert Wendeschneidplatte	Yedek Parçaları / Spare Parts / Ersatzteile		
		DC	ZEFP	DCON	LF	LH	APMX		Sıkma Vidası Screw Schraube	Tork Anahtar Torx Key Torx-Schlüssel	
AEM90-R390.11-D12-W12-L100-Z01	●	12	1	12	100	25	10	R390-11T3..		3008-M2.5x5	
AEM90-R390.11-D16-W16-L100-Z02-H	●	16	2	16	100	30	10				
AEM90-R390.11-D16-W16-L150-Z02	●	16	2	16	150	50	10				
AEM90-R390.11-D16-W16-L150-Z02-H	●	16	2	16	150	50	10				
AEM90-R390.11-D20-W20-L090-Z02-H	●	20	2	20	90	30	10				
AEM90-R390.11-D20-W20-L100-Z03-H	●	20	3	20	100	30	10				
AEM90-R390.11-D20-W20-L150-Z03	●	20	3	20	150	50	10				
AEM90-R390.11-D20-W20-L150-Z03-H	●	20	3	20	150	50	10				
AEM90-R390.11-D20-C20-L150-Z03	●	20	3	20	150	30	10				
AEM90-R390.11-D22-W20-L090-Z02-H	●	22	2	20	90	30	10				
AEM90-R390.11-D25-C20-L150-Z03	●	25	3	20	150	40	10				
AEM90-R390.11-D25-W25-L100-Z03-H	●	25	3	25	100	30	10				
AEM90-R390.11-D25-W25-L150-Z03	●	25	3	25	150	50	10				
AEM90-R390.11-D25-W25-L150-Z03-H	●	25	3	25	150	50	10				
AEM90-R390.11-D30-W25-L150-Z04-H	●	30	4	25	150	30	10				
AEM90-R390.11-D32-C25-L200-Z03	●	32	3	25	200	40	10				
AEM90-R390.11-D32-W32-L150-Z05-H	●	32	5	32	150	50	10				
AEM90-R390.17-D25-W25-L150-Z02	●	25	2	25	150	50	15.4				
AEM90-R390.17-D25-W25-L150-Z02-H	●	25	2	25	150	50	15.4				
AEM90-R390.17-D30-W25-L150-Z03	●	30	3	25	150	40	15.4				
AEM90-R390.17-D30-W25-L150-Z03-H	●	30	3	25	150	40	15.4				
AEM90-R390.17-D32-W32-L150-Z03-H	●	32	3	32	150	40	15.4				
AEM90-R390.18-D32-C32-L150-Z03	●	32	3	32	150	45	15.4				
AEM90-R390.18-D40-C32-L150-Z04-H	●	40	4	32	150	40	15.4				

R: Sağ / Right / Rechts! L: Sol / Left / Links

● Stokta / In Stock / Auf Lager ○ Stokta Yok / Non Stock Item / Kein Lagerartikel, Lieferzeit auf Anfrage  
SNDVK Ucuna Uygundur. / Compatible with SNDVK Insert. / Kompatibel mit SNDVK Wendeplatten.

Sipariş Örneği/Ordering Example/Bestellbeispiel

1 ad./pcs./stück AEM90-L010-D16-W16-L100-Z02

Kesme Hesabı : S 377/ Cutting Calculation : P 377 / Schnittberechnung : P 377

# S-SİSTEM YÜZEY PARMAK FREZELER

S-SYSTEM END MILLS

S-SYSTEM SCHAFTFRÄSER

KAPR=90°

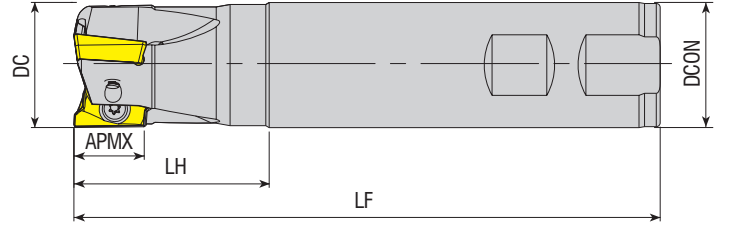

**Takım Kodu**  
**Ordering Code**  
**Bestell-Bezeichnung**

Stok  
Stock  
Lager

Takım Ölçüleri (mm)  
Dimension (mm)  
Abmessung (mm)

Kesici Uç  
Insert  
Wendeschneidplatte

Yedek Parçaları / Spare Parts / Ersatzteile

Sıkma Vidası  
Screw  
Schraube

Tork Anahtar  
Torx Key  
Torx-Schlüssel

Takım Kodu Ordering Code Bestell-Bezeichnung	Stok Stock Lager	DC	ZEFP	DCON	LF	LH	APMX	Kesici Uç Insert Wendeschneidplatte	Sıkma Vidası Screw Schraube	Tork Anahtar Torx Key Torx-Schlüssel			
AEM90-RT07-D10-W10-L120-Z02	●	10	2	10	120	30	7	RT 0702	3006-M2x4	82-T06			
AEM90-RT07-D12-C12-L120-Z02	●	12	2	12	120	30	7						
AEM90-RT07-D12-W12-L120-Z02	●	12	2	12	120	30	7						
AEM90-RT07-D14-W12-L120-Z02	●	14	2	12	120	30	7						
AEM90-RT10-D16-C15-L160-Z02	●	16	2	15	160	30	10						
AEM90-RT10-D16-W16-L120-Z02-H	●	16	2	16	120	30	10						
AEM90-RT10-D16-W16-L150-Z02	●	16	2	16	150	30	10						
AEM90-RT10-D16-C16-L200-Z02	●	16	2	16	200	100	10						
AEM90-RT10-D17-W16-L160-Z02	●	17	2	16	160	30	10						
AEM90-RT10-D17-C16-L200-Z02	●	17	2	16	200	30	10						
AEM90-RT10-D18-W16-L120-Z02-H	●	18	2	16	120	30	10	RT 1003	3008-M2.5x6	82-T08			
AEM90-RT10-D20-C19-L200-Z03	●	20	3	19	200	30	10						
AEM90-RT10-D20-C20-L110-Z03	●	20	3	20	110	30	10						
AEM90-RT10-D20-W20-L120-Z03-H	●	20	3	20	120	30	10						
AEM90-RT10-D20-W20-L150-Z03	●	20	3	20	150	50	10						
AEM90-RT10-D20-C20-L200-Z03	●	20	3	20	200	100	10						
AEM90-RT10-D21-W20-L200-Z03	●	21	3	20	200	30	10						
AEM90-RT10-D22-W20-L120-Z03-H	●	22	3	20	120	30	10						
AEM90-RT10-D22-C20-L150-Z03	●	22	3	20	150	30	10						
AEM90-RT10-D22-C20-L200-Z03	●	22	3	20	200	30	10						
AEM90-RT10-D25-W25-L120-Z04-H	●	25	4	25	120	40	10						
AEM90-RT10-D25-W25-L150-Z04	●	25	4	25	150	50	10						
AEM90-RT10-D25-C25-L200-Z04	●	25	4	25	200	100	10						
AEM90-RT10-D26-C25-L250-Z04	●	26	4	25	250	32	10						
AEM90-RT10-D32-W32-L120-Z05-H	●	32	5	32	120	50	10				RT 1304	3008-M3x8	
AEM90-RT10-D32-W32-L150-Z05	●	32	5	32	150	50	10						
AEM90-RT10-D32-C32-L200-Z05	●	32	5	32	200	100	10						
AEM90-RT10-D33-C32-L250-Z04	●	33	4	32	250	32	10						
AEM90-RT13-D32-C32-L250-Z04	●	32	4	32	250	50	13						
AEM90-RT16-D25-W25-L120-Z02-H	●	25	2	25	120	40	16	RT 1606	4015-M4x9	80-T15			
AEM90-RT16-D25-W25-L150-Z02	●	25	2	25	150	50	16						
AEM90-RT16-D25-C25-L200-Z02	●	25	2	25	200	100	16						
AEM90-RT16-D32-W32-L120-Z03-H	●	32	3	32	120	50	16						
AEM90-RT16-D32-W32-L150-Z03	●	32	3	32	150	50	16						
AEM90-RT16-D32-C32-L200-Z03	●	32	3	32	200	100	16						
AEM90-RT16-D32-C32-L250-Z03	●	32	3	32	250	100	16						
AEM90-RT16-D32-C32-L270-Z03	●	32	3	32	270	100	16						
AEM90-RT16-D40-W32-L120-Z04-H	●	40	4	32	120	50	16						
AEM90-RT16-D40-W32-L150-Z04	●	40	4	32	150	50	16						
AEM90-RT16-D40-C32-L200-Z04	●	40	4	32	200	100	16						
												4015-M4x11	

R: Sağ / Right / Rechtsl L: Sol / Left / Links

● Stokta / In Stock / Auf Lager ○ Stokta Yok / Non Stock Item / Kein Lagerartikel, Lieferzeit auf Anfrage  
SFTY Ucuna Uygundur. / Compatible with SFTY Insert. / Kompatibel mit SFTY Wendeplatten.

Sipariş Örneği/Ordering Example/Bestellbeispiel

1 ad./pcs./stück AEM90-RT07-D10-W10-L120-Z02

Kesme Hesabı : S 377 / Cutting Calculation : P 377 / Schnittberechnung : P 377



www.akkо.com.tr

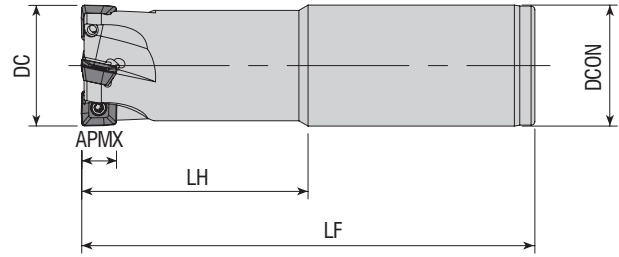

Takım Kodu Ordering Code Bestell-Bezeichnung	Stok Stock Lager	Takım Ölçüleri (mm) Dimension (mm) Abmessung (mm)						Kesici Uç Insert Wendeschneidplatte	Yedek Parçaları / Spare Parts / Ersatzteile		
		DC	ZEFP	DCON	LF	LH	APMX		Sıkma Vidası Screw Schraube	Tork Anahtar Torx Key Torx-Schlüssel	
AEM90-SE09-D25-C25-L120-Z03-H	●	25	3	25	120	60	6.7	SEET 09T3..		82-T08	
AEM90-SE09-D25-C25-L150-Z02	●	25	2	25	150	50	6.7				
AEM90-SE09-D32-C32-L120-Z04-H	●	32	4	32	120	60	6.7				
AEM90-SE09-D32-C32-L150-Z03	●	32	3	32	150	50	6.7				

ZCC Ucuna Uygun. / Compatible with ZCC Insert. / Kompatibel mit ZCC Wendeplatten.

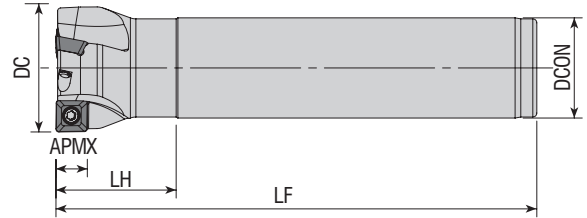

Takım Kodu Ordering Code Bestell-Bezeichnung	Stok Stock Lager	Takım Ölçüleri (mm) Dimension (mm) Abmessung (mm)						Kesici Uç Insert Wendeschneidplatte	Yedek Parçaları / Spare Parts / Ersatzteile		
		DC	ZEFP	DCON	LF	LH	APMX		Sıkma Vidası Screw Schraube	Tork Anahtar Torx Key Torx-Schlüssel	
AEM90-S00803-D20-C16-L110-Z02-H	●	20	2	16	110	25	7	SOMT 0803..		82-T08	
AEM90-S00803-D25-C20-L110-Z02-H	●	25	2	20	110	25	7				
AEM90-S00803-D32-C25-L120-Z03-H	●	32	3	25	120	30	7				

R: Sağ / Right / Rechts/ L: Sol / Left / Links

● Stokta / In Stock / Auf Lager ○ Stokta Yok / Non Stock Item / Kein Lagerartikel, Lieferzeit auf Anfrage  
SMTM Ucuna Uygun. / Compatible with SMTM Insert. / Kompatibel mit SMTM Wendeplatten.

Sipariş Örneği/Ordering Example/Bestellbeispiel  
1 ad./pcs./stück AEM90-SE09-D25-C25-L120-Z03-H  
Kesme Hesabı : S 377 / Cutting Calculation : P 377 / Schnittberechnung : P 377

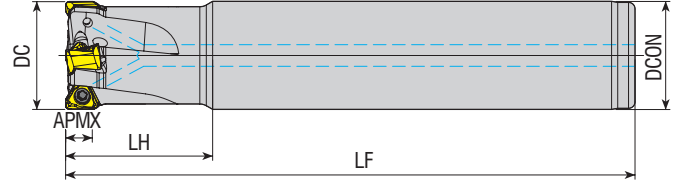

Takım Kodu Ordering Code Bestell-Bezeichnung	Stok Stock Lager	Takım Ölçüleri (mm) Dimension (mm) Abmessung (mm)						Kesici Uç Insert Wendeschneidplatte	Yedek Parçaları / Spare Parts / Ersatzteile				
		DC	ZAFP	DCON	LF	LH	APMX		Sıkma Vidası Screw Schraube	Tork Anahtar Torx Key Torx-Schlüssel			
<b>new</b> AEM90-TNG10-D20-W20-L90-Z02-H	●	20	2	20	90	32	5	TNGX 1004..	3008-M2.5x6	82-T08			
<b>new</b> AEM90-TNG10-D20-W20-L90-Z03-H	●	20	3	20	90	32	5						
AEM90-TNG10-D20-C20-L125-Z02-H	●	20	2	20	125	29	5						
AEM90-TNG10-D20-C20-L125-Z03-H	●	20	3	20	125	29	5						
AEM90-TNG10-D20-C20-L150-Z03-H	●	20	3	20	150	50	5						
AEM90-TNG10-D21-C20-L200-Z03-H	●	21	3	20	200	30	5						
AEM90-TNG10-D25-C25-L150-Z03-H	●	25	3	25	100	42	5						
<b>new</b> AEM90-TNG10-D25-W25-L100-Z03-H	●	25	4	25	100	42	5						
<b>new</b> AEM90-TNG10-D25-W25-L100-Z04-H	●	25	3	25	150	34	5						
AEM90-TNG10-D25-C25-L150-Z04-H	●	25	4	25	150	34	5						
AEM90-TNG10-D25-C25-L170-Z04-H	●	25	4	25	170	50	5						
AEM90-TNG10-D26-C25-L250-Z04-H	●	26	4	25	250	35	5						
<b>new</b> AEM90-TNG10-D28-W25-L100-Z04-H	●	28	4	25	100	29	5						
<b>new</b> AEM90-TNG10-D32-W32-L110-Z04-H	●	32	4	32	110	42	5						
<b>new</b> AEM90-TNG10-D32-W32-L110-Z05-H	●	32	5	32	110	42	5						
AEM90-TNG10-D32-C32-L170-Z04-H	●	32	4	32	170	37	5						
AEM90-TNG10-D32-C32-L170-Z05-H	●	32	5	32	170	37	5						
AEM90-TNG10-D33-C32-L250-Z05-H	●	33	5	32	250	35	5						
AEM90-TNG16-D25-C25-L170-Z02-H	●	25	2	25	170	34	10				TNGX 1606..	3015-M4x11	80-T15
AEM90-TNG16-D25-C25-L170-Z02-H-80	●	25	2	25	170	80	10						
AEM90-TNG16-D25-W25-L110-Z02-H	●	25	2	25	110	42	10						
AEM90-TNG16-D32-C32-L195-Z02-H	●	32	2	32	195	34	10						
AEM90-TNG16-D32-C32-L195-Z02-H-80	●	32	2	32	195	80	10						
AEM90-TNG16-D32-C32-L195-Z03-H	●	32	3	32	195	34	10						
AEM90-TNG16-D32-W32-L110-Z03-H	●	32	3	32	110	42	10						
AEM90-TNG16-D35-C32-L195-Z04-H	●	35	4	32	195	34	10						
AEM90-TNG16-D40-W32-L120-Z04-H	●	40	4	32	120	50	10						

R: Sağ / Right / Rechtsl L: Sol / Left / Links  
● Stokta / In Stock / Auf Lager ○ Stokta Yok / Non Stock Item / Kein Lagerartikel, Lieferzeit auf Anfrage  
PRMT Ucuna Uygunudur. / Compatible with PRMT Insert. / Kompatibel mit PRMT Wendeplatten.

Sipariş Örneği/Ordering Example/Bestellbeispiel  
1 ad./pcs./stück AEM90-TNG10-D20-W20-L90-Z02-H  
Kesme Hesabı : S 377/ Cutting Calculation : P 377 / Schnittberechnung : P 377

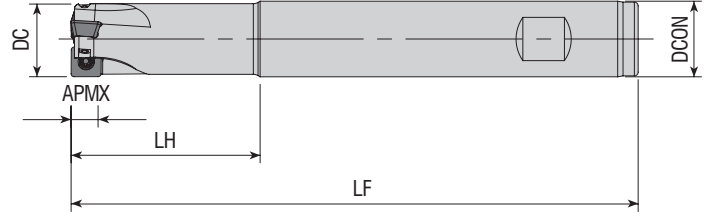

Takım Kodu Ordering Code Bestell-Bezeichnung	Stok Stock Lager	Takım Ölçüleri (mm) Dimension (mm) Abmessung (mm)						Kesici Uç Insert Wendeschneidplatte	Yedek Parçaları / Spare Parts / Ersatzteile	
		DC	ZEPF	DCON	LF	LH	APMX		Sıkma Vidası Screw Schraube	Tork Anahtar Torx Key Torx-Schlüssel
AEM90-SPGT0602-D16-W16-L150-Z02	●	16	2	16	150	50	5.5			
AEM90-SPGT07T3-D20-W20-L150-Z03	●	20	3	20	150	50	7			
AEM90-SPGT07T3-D25-W25-L150-Z03	●	25	3	25	150	50	7			
AEM90-SPGT0904-D30-W32-L150-Z03	●	30	3	32	150	50	9			

ZCC Ucuna Uygunur. / Compatible with ZCC Insert. / Kompatibel mit ZCC Wendeplatten Wendeplatten.

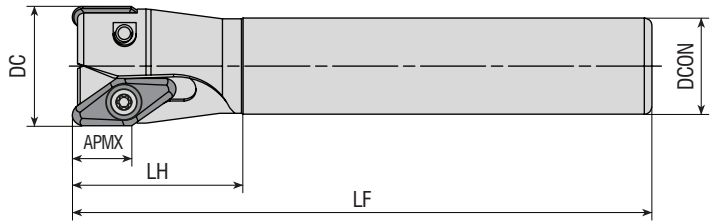

Takım Kodu Ordering Code Bestell-Bezeichnung	Stok Stock Lager	Takım Ölçüleri (mm) Dimension (mm) Abmessung (mm)						Kesici Uç Insert Wendeschneidplatte	Yedek Parçaları / Spare Parts / Ersatzteile	
		DC	ZEPF	DCON	LF	LH	APMX		Sıkma Vidası Screw Schraube	Tork Anahtar Torx Key Torx-Schlüssel
AEM90-VC2205-D32-C25-L150-Z02-H	●	32	2	25	150	50	15			
AEM90-VC2205-D40-C32-L150-Z03-H	●	40	3	32	150	50	15			

R: Sağ / Right / Rechts/ L: Sol / Left / Links

● Stokta / In Stock / Auf Lager ○ Stokta Yok / Non Stock Item / Kein Lagerartikel, Lieferzeit auf Anfrage  
ISO Ucuna Uygunur. / Compatible with ISO Insert. / Kompatibel mit ISO Wendeplatten.

Sipariş Örneği/Ordering Example/Bestellbeispiel  
1 ad./pcs./stück AEM90-SPGT0602-D16-W16-L150-Z02  
Kesme Hesabı : S 377/ Cutting Calculation : P 377 / Schnittberechnung : P 377

KAPR=90°

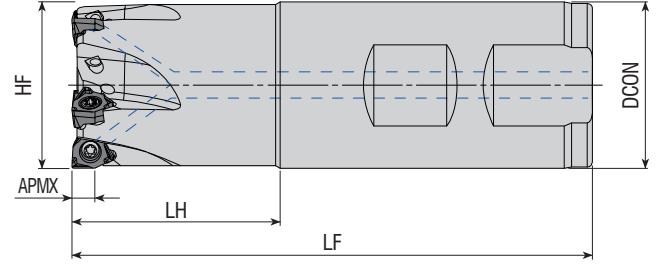

Takım Kodu Ordering Code Bestell-Bezeichnung	Stok Stock Lager	Takım Ölçüleri (mm) Dimension (mm) Abmessung (mm)						Kesici Uç Insert Wendeschneidplatte	Yedek Parçaları / Spare Parts / Ersatzteile		
		DC	ZEFP	DCON	LF	LH	APMX		Sıkma Vidası Screw Schraube	Tork Anahtar Torx Key Torx-Schlüssel	
new AEM90-WNG04-D20-W20-L81-Z02-H	●	20	2	20	81	31	4	WNGU 0403..	3008-M3x6	82-T08	
AEM90-WNG04-D20-W20-L81-Z03-H	●	20	3	20	81	31	4				
new AEM90-WNG04-D20-C20-L170-Z02-H	●	20	2	20	170	50	4				
AEM90-WNG04-D20-C20-L170-Z03-H	●	20	3	20	170	50	4				
AEM90-WNG04-D25-W25-L88-Z03-H	●	25	3	25	88	32	4				
AEM90-WNG04-D25-W25-L88-Z04-H	●	25	4	25	88	32	4				
new AEM90-WNG04-D25-C25-L170-Z02-H	●	25	2	25	170	50	4				
AEM90-WNG04-D25-C25-L170-Z03-H	●	25	3	25	170	50	4				
AEM90-WNG04-D32-W25-L100-Z05-H	●	32	5	25	100	35	4				
AEM90-WNG04-D32-W32-L100-Z05-H	●	32	5	32	100	40	4				
new AEM90-WNG04-D32-C32-L170-Z03-H	●	32	3	32	170	50	4				
AEM90-WNG04-D32-C25-L170-Z04-H	●	32	4	25	170	35	4				
AEM90-WNG04-D32-C32-L170-Z04-H	●	32	4	32	170	50	4				
new AEM90-WNG08-D32-C32-L170-Z02-H	●	32	2	32	170	50	7.5	WNGU 0806..	4015-M4x11	80-T15	
AEM90-WNG08-D40-W32-L100-Z03-H	●	40	3	32	100	35	7.5				
new AEM90-WNG08-D40-W40-L110-Z03-H	●	40	3	40	110	40	7.5				
AEM90-WNG08-D40-C32-L170-Z03-H	●	40	3	32	170	35	7.5				

XTC-GSC Ucuna Uygunur. / Compatible with XTC-GSC Insert. / Kompatibel mit XTC-GSC Wendeplatten.

KAPR=90°

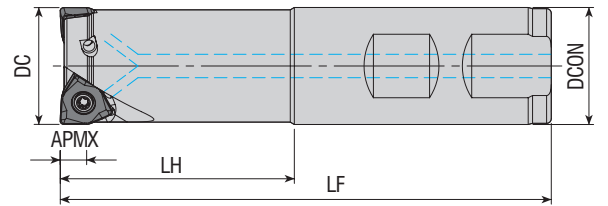

Takım Kodu Ordering Code Bestell-Bezeichnung	Stok Stock Lager	Takım Ölçüleri (mm) Dimension (mm) Abmessung (mm)						Kesici Uç Insert Wendeschneidplatte	Yedek Parçaları / Spare Parts / Ersatzteile		
		DC	ZEFP	DCON	LF	LH	APMX		Sıkma Vidası Screw Schraube	Tork Anahtar Torx Key Torx-Schlüssel	
AEM90L-WN0604Z-D25-C25-L200-Z02-H	●	25	2	25	200	100	5.7	WNHU 0604..	3008-M3x8	82-T08	
AEM90L-WN0604Z-D25-W25-L150-Z02-H	●	25	2	25	150	50	5.7				
AEM90L-WN0604Z-D32-W32-L150-Z03-H	●	32	3	32	150	50	5.7				
AEM90L-WN0604Z-D40-W32-L150-Z04-H	●	40	4	32	150	35	5.7				

R: Sağ / Right / Rechts | L: Sol / Left / Links



● Stokta / In Stock / Auf Lager ○ Stokta Yok / Non Stock Item / Kein Lagerartikel, Lieferzeit auf Anfrage  
ZCC Ucuna Uygunur. / Compatible with ZCC Insert. / Kompatibel mit ZCC Wendeplatten.

Sipariş Örneği/Ordering Example/Bestellbeispiel

1 ad./pcs./stück AEM90-WNG04-D20-W20-L81-Z02-H

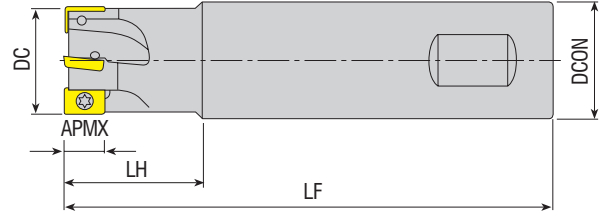
Kesme Hesabı : S 377 / Cutting Calculation : P 377 / Schnittberechnung : P 377



Takım Kodu Ordering Code Bestell-Bezeichnung	Stok Stock Lager	Takım Ölçüleri (mm) Dimension (mm) Abmessung (mm)						Kesici Uç Insert Wendeschneidplatte	Yedek Parçaları / Spare Parts / Ersatzteile		
		DC	ZEFP	DCON	LF	LH	APMX		Sıkma Vidası Screw Schraube	Tork Anahtar Torx Key Torx-Schlüssel	
AEM90-XD11T3-D16-W16-L150-Z02	●	16	2	16	150	30	10		3008-M2.5x5		
AEM90-XD11T3-D17-C16-L150-Z02	●	17	2	16	150	30	10				
AEM90-XD11T3-D20-W20-L150-Z03	●	20	3	20	150	50	10				
AEM90-XD11T3-D21-C20-L080-Z03-H	●	21	3	20	80	25	10		XD.T 11T3..		3008-M2.5x6
AEM90-XD11T3-D21-C20-L150-Z03	●	21	3	20	150	30	10				
AEM90-XD11T3-D25-W25-L150-Z04	●	25	4	25	150	50	10				
AEM90-XD11T3-D30-W25-L120-Z04	●	30	4	25	120	30	10				
AEM90-XD11T3-D32-W32-L150-Z04	●	32	4	32	150	50	10				
AEM90-XD11T3-D33-C20-L080-Z04-H	●	33	4	20	80	30	10				

CRTZT Ucuna Uygunur. / Compatible with CRTZT Insert. / Kompatibel mit CRTZT Wendeplatten.

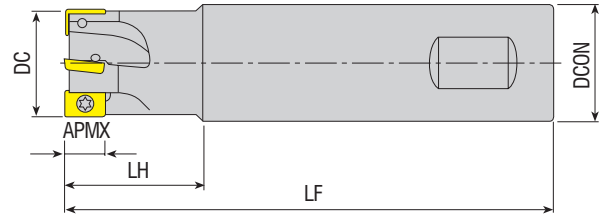

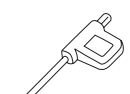
Takım Kodu Ordering Code Bestell-Bezeichnung	Stok Stock Lager	Takım Ölçüleri (mm) Dimension (mm) Abmessung (mm)						Kesici Uç Insert Wendeschneidplatte	Yedek Parçaları / Spare Parts / Ersatzteile		
		DC	ZEFP	DCON	LF	LH	APMX		Sıkma Vidası Screw Schraube	Tork Anahtar Torx Key Torx-Schlüssel	
AEM90-XC13-D20-W20-L150-Z02	●	20	2	20	150	60	13		3008-M3x6		
AEM90-XC13-D25-W25-L150-Z03	●	25	3	25	150	60	13		XCKX 13T3..		3008-M3x8
AEM90-XC13-D32-W32-L150-Z04	●	32	4	32	150	60	13				

R: Sağ / Right / Rechts/ L: Sol / Left / Links

● Stokta / In Stock / Auf Lager ○ Stokta Yok / Non Stock Item / Kein Lagerartikel, Lieferzeit auf Anfrage  
SC Ucuna Uygunur. / Compatible with SC Insert. / Kompatibel mit SC Wendeplatten.

Sipariş Örneği/Ordering Example/Bestellbeispiel

1 ad./pcs./stück AEM90-XD11T3-D16-W16-L150-Z02

Kesme Hesabı : S 377 / Cutting Calculation : P 377 / Schnittberechnung : P 377

## S-SİSTEM YÜZEY PARMAK FREZELER

S-SYSTEM END MILLS

S-SYSTEM SCHAFTFRÄSER

KAPR=90°

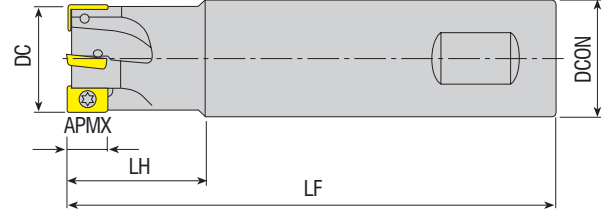

Takım Kodu Ordering Code Bestell-Bezeichnung	Stok Stock Lager	Takım Ölçüleri (mm) Dimension (mm) Abmessung (mm)						Kesici Uç Insert Wendeschneidplatte	Yedek Parçaları / Spare Parts / Ersatzteile		
		DC	ZEFP	DCON	LF	LH	APMX		Sıkma Vidası Screw Schraube	Tork Anahtar Torx Key Torx-Schlüssel	
AEM90-X006-D10-C12-L120-Z02	●	10	2	12	120	50	5	XO.. 0602..	3006-M1.8x4	82-T06	
AEM90-X006-D12-C12-L120-Z02	●	12	2	12	120	25	5				
AEM90-X009-D16-W16-L150-Z02	●	16	2	16	150	50	8	XO.. 0903..	3008-M2.5x5	82-T08	
AEM90-X009-D20-W20-L150-Z03	●	20	3	20	150	50	8				
AEM90-X012-D20-W20-L150-Z02	●	20	2	20	150	50	11	XO.. 1204..	3010-M3.5x7	82-T10	
AEM90-X012-D20-C20-L200-Z02	●	20	2	20	200	100	11				
AEM90-X012-D22-W20-L150-Z02	●	22	2	20	150	30	11				
AEM90-X012-D25-W25-L150-Z03	●	25	3	25	150	50	11				
AEM90-X012-D25-C25-L200-Z03	●	25	3	25	200	100	11				
AEM90-X012-D32-C25-L150-Z04	●	32	4	25	150	40	11				
AEM90-X012-D32-W32-L150-Z04	●	32	4	32	150	50	11				
AEM90-X012-D32-C32-L250-Z04	●	32	4	32	250	100	11				

SC Ucuna Uygundur. / Compatible with SC Insert. / Kompatibel mit SC Wendeplatten.

KAPR=90°

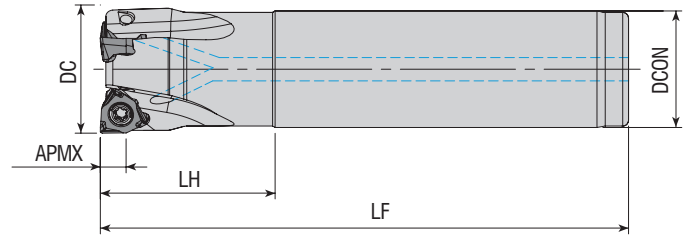

Takım Kodu Ordering Code Bestell-Bezeichnung	Stok Stock Lager	Takım Ölçüleri (mm) Dimension (mm) Abmessung (mm)						Kesici Uç Insert Wendeschneidplatte	Yedek Parçaları / Spare Parts / Ersatzteile		
		DC	ZEFP	DCON	LF	LH	APMX		Sıkma Vidası Screw Schraube	Tork Anahtar Torx Key Torx-Schlüssel	
AEM90-XN0403-D16-C16-L100-Z01-H	●	16	1	16	100	30	4	XNEX 0403..	3008-M2.5x6	82-T08	
AEM90-XN0403-D22-C20-L110-Z03-H	●	22	3	20	110	30	4				
AEM90-XN0806-D32-C32-L110-Z02-H	●	32	2	32	110	40	7.5	XNEX 0806..	4015-M4x11	80-T15	

R: Sağ / Right / Rechts/ L: Sol / Left / Links

● Stokta / In Stock / Auf Lager ○ Stokta Yok / Non Stock Item / Kein Lagerartikel, Lieferzeit auf Anfrage

SC Ucuna Uygundur. / Compatible with SC Insert. / Kompatibel mit SC Wendeplatten.

Sipariş Örneği/Ordering Example/Bestellbeispiel

1 ad./pcs./stück AEM90-X006-D10-C12-L120-Z02

Kesme Hesabı : S 377 / Cutting Calculation : P 377 / Schnittberechnung : P 377



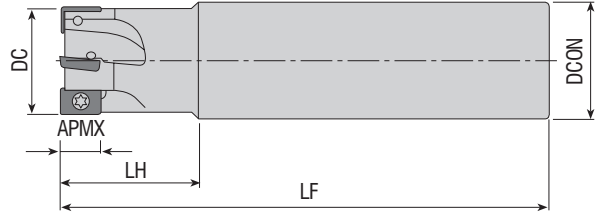

Takım Kodu Ordering Code Bestell-Bezeichnung	Stok Stock Lager	Takım Ölçüleri (mm) Dimension (mm) Abmessung (mm)						Kesici Uç Insert Wendeschneidplatte	Yedek Parçaları / Spare Parts / Ersatzteile	
		DC	ZEFP	DCON	LF	LH	APMX		Sıkma Vidası Screw Schraube	Tork Anahtar Torx Key Torx-Schlüssel
AEM90-ZC1003-D16-C14-L150-Z02	●	16	2	14	150	25	9	ZCMT 100308R	3008-M2.5x6	82-T08
AEM90-ZC1003-D16-C14-L200-Z02	●	16	2	14	200	25	9			
AEM90-ZC1003-D16-C15-L150-Z02	●	16	2	15	150	25	9			
AEM90-ZC1003-D16-C16-L150-Z02	●	16	2	16	150	25	9			
AEM90-ZC1003-D16-C16-L200-Z02	●	16	2	16	200	50	9			
AEM90-ZC1003-D17-C16-L150-Z02	●	17	2	16	150	25	9			
AEM90-ZC1003-D17-C16-L200-Z02	●	17	2	16	200	25	9			
AEM90-ZC1003-D20-C18-L150-Z03	●	20	3	18	150	25	9			
AEM90-ZC1003-D20-C18-L200-Z02	●	20	2	18	200	25	9			
AEM90-ZC1003-D20-C20-L150-Z03	●	20	3	20	150	40	9			
AEM90-ZC1003-D20-C18-L200-Z03	●	20	3	18	200	25	9			
AEM90-ZC1003-D21-C20-L150-Z02	●	21	2	20	150	30	9			
AEM90-ZC1003-D21-C20-L150-Z03	●	21	3	20	150	30	9			
AEM90-ZC1003-D21-C20-L200-Z03	●	21	3	20	200	30	9			
AEM90-ZC1003-D25-C20-L150-Z03	●	25	3	20	150	30	9			
AEM90-ZC1003-D25-C20-L200-Z03	●	25	3	20	200	30	9			
AEM90-ZC1003-D25-C25-L150-Z03	●	25	3	25	150	40	9			
AEM90-ZC1003-D26-C25-L170-Z03	●	26	3	25	170	25	9			
AEM90-ZC1003-D26-C25-L200-Z03	●	26	3	25	200	25	9			
AEM90-ZC1003-D32-C25-L180-Z04	●	32	4	25	180	30	9			
AEM90-ZC1003-D33-C32-L200-Z04	●	33	4	32	200	25	9			

DJT Ucuna Uygunudur. / Compatible with DJT Insert. / Kompatibel mit DJT Wendepplatten.

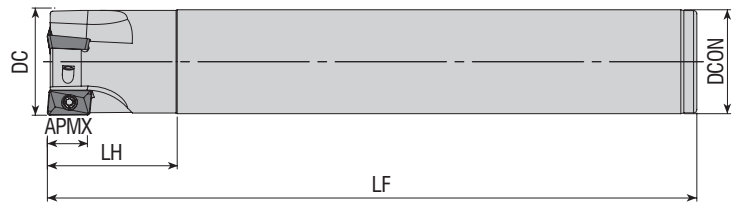

Takım Kodu Ordering Code Bestell-Bezeichnung	Stok Stock Lager	Takım Ölçüleri (mm) Dimension (mm) Abmessung (mm)						Kesici Uç Insert Wendeschneidplatte	Yedek Parçaları / Spare Parts / Ersatzteile	
		DC	ZEFP	DCON	LF	LH	APMX		Sıkma Vidası Screw Schraube	Tork Anahtar Torx Key Torx-Schlüssel
AEM90-ZP13T3-D26-C25-L200-Z02	●	26	2	25	200	35	13	ZPMT 13T3..	4010-M3x8	82-T10
AEM90-ZP13T3-D26-C25-L200-Z03	●	26	3	25	200	35	13			
AEM90-ZP13T3-D26-C25-L250-Z02	●	26	2	25	250	35	13			
AEM90-ZP13T3-D33-C32-L200-Z03	●	33	3	32	200	40	13			
AEM90-ZP13T3-D33-C32-L250-Z03	●	33	3	32	250	40	13			

R: Sağ / Right / Rechts | L: Sol / Left / Links

● Stokta / In Stock / Auf Lager ○ Stokta Yok / Non Stock Item / Kein Lagerartikel, Lieferzeit auf Anfrage

DJT Ucuna Uygunudur. / Compatible with DJT Insert. / Kompatibel mit DJT Wendepplatten.

Sipariş Örneği/Ordering Example/Bestellbeispiel

1 ad./pcs./stück AEM90-ZC1003-D16-C14-L150-Z02

Kesme Hesabı : S 377 / Cutting Calculation : P 377 / Schnittberechnung : P 377

## S-SİSTEM YÜZEY PARMAK FREZELER

S-SYSTEM END MILLS

S-SYSTEM SCHAFTFRÄSER

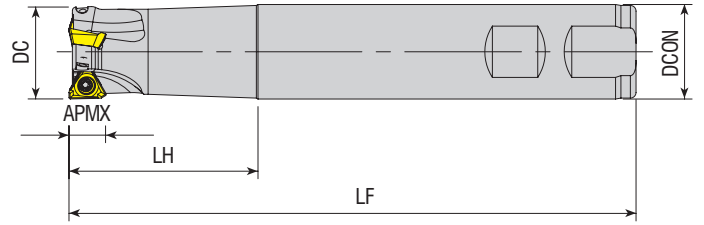

Takım Kodu Ordering Code Bestell-Bezeichnung	Stok Stock Lager	Takım Ölçüleri (mm) Dimension (mm) Abmessung (mm)						Kesici Uç Insert Wendeschneidplatte	Yedek Parçaları / Spare Parts / Ersatzteile	
		DC	ZEFP	DCON	LF	LH	APMX		Sıkma Vidası Screw Schraube	Tork Anahtar Torx Key Torx-Schlüssel
<b>new</b> AEM90-3P0603-D12-C12-L120-Z01-H	●	12	1	12	120	25	4.7	<b>3PKT 0603</b>	3006-M2x4	82-T06
AEM90-3P0603-D16-W16-L120-Z03-H	●	16	3	16	120	25	4.7			
AEM90-3P0603-D20-W20-L150-Z03-H	●	20	3	20	150	25	4.7			
AEM90-3P0603-D25-W25-L150-Z05-H	●	25	5	25	150	25	4.7			
AEM90-3P1004-D20-W20-L150-Z02	●	20	2	20	150	40	7	<b>3PKT 1004</b>	1108-M2.5x6	82-T08
AEM90-3P1004-D21-C20-L200-Z02	●	21	2	20	200	30	7			
<b>new</b> AEM90-3P1004-D22-W20-L150-Z02	●	22	2	20	150	30	7	<b>3PKT 1505</b>	1115-M4x10	80-T15
AEM90-3P1004-D25-W25-L150-Z03	●	25	3	25	150	40	7			
AEM90-3P1505-D32-W32-L150-Z03	●	32	3	32	150	50	11			
AEM90-3P1505-D38-W32-L150-Z03	●	38	3	32	150	35	11	<b>3PKT 1505</b>	1115-M4x10	80-T15
AEM90-3P1505-D40-W32-L150-Z04	●	40	4	32	150	35	11			

TGTC Ucuna Uygun. / Compatible with TGTC Insert. / Kompatibel mit TGTC Wendeplatten.

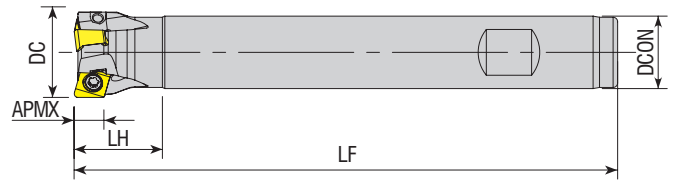

Takım Kodu Ordering Code Bestell-Bezeichnung	Stok Stock Lager	Takım Ölçüleri (mm) Dimension (mm) Abmessung (mm)						Kesici Uç Insert Wendeschneidplatte	Yedek Parçaları / Spare Parts / Ersatzteile	
		DC	ZEFP	DCON	LF	LH	APMX		Sıkma Vidası Screw Schraube	Tork Anahtar Torx Key Torx-Schlüssel
AEM90-4N06-D16-W16-L120-Z02-H	●	16	2	16	120	25	6	<b>4NKT 0603..</b>	1108-M3x6.8	82-T08
AEM90-4N06-D16-W16-L160-Z02	●	16	2	16	160	25	6			
AEM90-4N06-D20-W16-L120-Z03-H	●	20	3	16	120	20	6			
AEM90-4N06-D20-W16-L160-Z03	●	20	3	16	160	20	6			
<b>new</b> AEM90-4N06-D20-W20-L160-Z03	●	20	3	20	160	25	6			

TGTC Ucuna Uygun. / Compatible with TGTC Insert. / Kompatibel mit TGTC Wendeplatten.

R: Sağ / Right / Rechts | L: Sol / Left / Links

● Stokta / In Stock / Auf Lager ○ Stokta Yok / Non Stock Item / Kein Lagerartikel, Lieferzeit auf Anfrage

Sipariş Örneği/Ordering Example/Bestellbeispiel

1 ad./pcs./stück AEM90-3P0603-D12-C12-L120-Z01-H

Kesme Hesabı : S 377/ Cutting Calculation : P 377 / Schnittberechnung : P 377

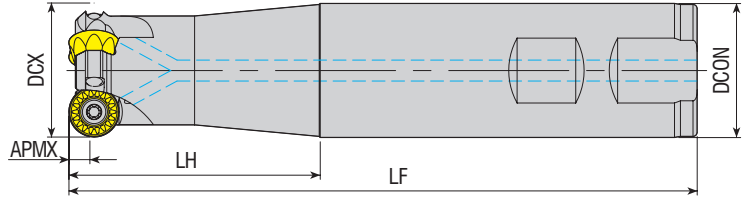

Takım Kodu Ordering Code Bestell-Bezeichnung	Stok Stock Lager	Takım Ölçüleri (mm) Dimension (mm) Abmessung (mm)						Kesici Uç Insert Wendeschneidplatte	Yedek Parçaları / Spare Parts / Ersatzteile			
		DCX	ZEFP	DCON	LF	LH	APMX		Sıkma Vidası Screw Schraube	Baskı Parçası Wedge Clamp Spannpratze	Baskı Vidası Clamp Screw Schraube	Tork Anahtar Torx Key Torx-Schlüssel
AEMR-RP08T2M-D20-W20-L150-Z02-H	●	20	2	20	150	60	4	RPMT 08T2..	3008-M2.5x6	-	-	82-T08
AEMR-RP08T2M-D25-W25-L200-Z03-H	●	25	3	25	200	100	4					
AEMR-RP10T3M-D25-W25-L200-Z02-H	●	25	2	25	200	100	5	RPMT 10T3..	4015-M3.5x9	-	-	
AEMR-RP10T3M-D32-W32-L200-Z03-H	●	32	3	32	200	100	5					
new AEMR-RP1204M-D25-C25-L180-Z02	●	25	2	25	180	50	6	RPMT 1204..	4015-M4x9	-	-	80-T15
new AEMR-RP1204M-D25-C25-L180-Z02-H	●	25	2	25	180	50	6					
AEMR-RP1204M-D32-W32-L150-Z03-H	●	32	3	32	150	60	6					
AEMR-RP1204M-D32-W32-L200-Z03-H	●	32	3	32	200	100	6					
new AEMR-RP1204M-D36-C25-L160-Z03	●	36	3	25	160	30	3	RPMT 1606..	1020-M5x11	-	-	80-T20
AEMR-RP1606M-D40-W32-L150-Z02-H	●	40	2	16	150	35	8					
AEMR-RP1606M-D40-W32-L200-Z02-H	●	40	2	16	200	35	8					

R: Sağ / Right / Rechts L: Sol / Left / Links

● Stokta / In Stock / Auf Lager ○ Stokta Yok / Non Stock Item / Kein Lagerartikel, Lieferzeit auf Anfrage  
MTSBH Ucuna Uygunudur. / Compatible with MTSBH Insert. / Kompatibel mit MTSBH Wendeplatten.

Sipariş Örneği/Ordering Example/Bestellbeispiel

1 ad./pcs./stück AEMR-RP08T2M-D20-W20-L150-Z02-H

Kesme Hesabı : S 377 / Cutting Calculation : P 377 / Schnittberechnung : P 377



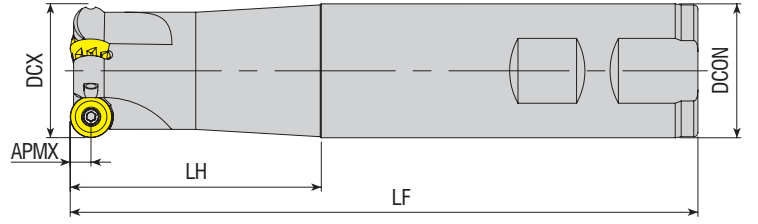

Takım Kodu Ordering Code Bestell-Bezeichnung	Stok Stock Lager	Takım Ölçüleri (mm) Dimension (mm) Abmessung (mm)						Kesici Uç Insert Wendeschneidplatte	Yedek Parçaları / Spare Parts / Ersatzteile			
		DCX	ZEFP	DCON	LF	LH	APMX		Sıkma Vidası Screw Schraube	Baskı Parçası Wedge Clamp Spannpratze	Baskı Vidası Clamp Screw Schraube	Tork Anahtar Torx Key Torx-Schlüssel
AEMR-RP10T3-D25-W25-L125-Z02	●	25	2	25	125	60	5	RPNX 10T3..	4010-M3x8	-	-	82-T10
AEMR-RP10T3-D25-W25-L150-Z02	●	25	2	25	150	60	5					
AEMR-RP10T3-D32-W32-L150-Z03	●	32	3	32	150	60	5					

CRTZT Ucuna Uygun. / Compatible with CRTZT Insert. / Kompatibel mit CRTZT Wendeplatten.

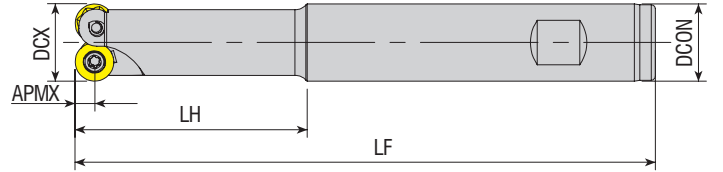

Takım Kodu Ordering Code Bestell-Bezeichnung	Stok Stock Lager	Takım Ölçüleri (mm) Dimension (mm) Abmessung (mm)						Kesici Uç Insert Wendeschneidplatte	Yedek Parçaları / Spare Parts / Ersatzteile		
		DCX	ZEFP	DCON	LF	LH	APMX		Sıkma Vidası Screw Schraube	Tork Anahtar Torx Key Torx-Schlüssel	
AEMR-RY08-D16-W16-L150-Z02	●	16	2	16	150	55	4	RYMX 0803..	4010-M3x6	82-T10	
AEMR-RY10-D20-W20-L150-Z02	●	20	2	20	150	60	5	RYMX 1004..	4015-M3.5x8	80-T15	
AEMR-RY10-D20-C20-L200-Z02	●	20	2	20	200	100	5				
AEMR-RY10-D21-W20-L200-Z02-H	●	21	2	20	200	30	5				
AEMR-RY10-D25-W25-L150-Z02	●	25	2	25	150	60	5	RYMX 1205..	4015-M4x11		
AEMR-RY10-D26-W25-L200-Z02-H	●	26	2	25	200	60	5				
AEMR-RY10-D32-W32-L160-Z04-H	●	32	4	32	160	60	5				
AEMR-RY12-D32-C25-L160-Z03	●	32	3	25	160	30	6				

R: Sağ / Right / Rechts/ L: Sol / Left / Links

● Stokta / In Stock / Auf Lager ○ Stokta Yok / Non Stock Item / Kein Lagerartikel, Lieferzeit auf Anfrage  
 TGTC Ucuna Uygun. / Compatible with TGTC Insert. / Kompatibel mit TGTC Wendeplatten.

Sipariş Örneği/Ordering Example/Bestellbeispiel

1 ad./pcs./stück AEMR-RP10T3-D25-W25-L125-Z02

Kesme Hesabı : S 377/ Cutting Calculation : P 377 / Schnittberechnung : P 377

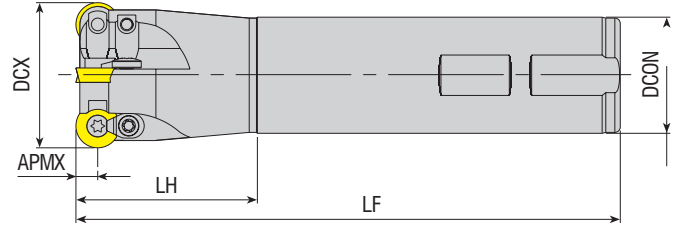

**Takım Kodu**  
**Ordering Code**  
**Bestell-Bezeichnung**

Takım Kodu Ordering Code Bestell-Bezeichnung	Stok Stock Lager	Takım Ölçüleri (mm) Dimension (mm) Abmessung (mm)						Kesici Uç Insert Wendeschneidplatte	Yedek Parçaları / Spare Parts / Ersatzteile								
		DCX	ZEP	DCON	LF	LH	APMX		Sıkma Vidası Screw Schraube	Baskı Parçası Wedge Clamp Spannpratze	Baskı Vidası Clamp Screw Schraube	Tork Anahtar Torx Key Torx-Schlüssel					
AEMR-RD0501-D08-W10-L100-Z01-H	●	8	1	10	100	20	2.5	RD.. 0501	3006-M2x3.6			82-T06					
AEMR-RD0501-D10-W12-L100-Z02-H	●	10	2	12	100	20	2.5										
AEMR-RD0501-D12-W12-L120-Z02-H	●	12	2	12	120	20	2.5										
AEMR-RD0803-D16-W16-L150-Z02	●	16	2	16	150	60	4	RD.. 0803	3008-M3x6	-	-	82-T08					
AEMR-RD0803-D16-C20-L200-Z02	●	16	2	20	200	60	4										
AEMR-RD0803-D20-W20-L150-Z03	●	20	3	20	150	60	4	RD.. 08T2	3008-M2.5x6								
AEMR-RD08T2-D16-W16-L150-Z02	●	16	2	16	150	60	4										
AEMR-RD08T2-D20-W20-L150-Z02	●	20	2	20	150	60	4	RD.. 1003									
AEMRC-RD1003-D20-W20-L150-Z02	●	20	2	20	150	60	5										
AEMRC-RD1003-D20-C20-L160-Z02	●	20	2	20	160	70	5										
AEMRC-RD1003-D20-C20-L250-Z02	●	20	2	20	250	150	5										
AEMRC-RD1003-D21-C20-L160-Z02	●	21	2	20	160	70	5										
AEMRC-RD1003-D25-W25-L150-Z02	●	25	2	25	150	60	5										
AEMRC-RD1003-D25-C25-L160-Z02	●	25	2	25	160	70	5										
AEMRC-RD1003-D25-C25-L200-Z02	●	25	2	25	200	100	5										
AEMRC-RD1003-D25-C25-L200-Z02	●	25	2	25	200	100	5										
AEMRC-RD1003-D25-C25-L250-Z02	●	25	2	25	250	150	5										
AEMRC-RD1003-D26-C25-L160-Z02	●	26	2	25	160	70	5										
AEMRC-RD1003-D32-W32-L150-Z03	●	32	3	32	150	60	5										
AEMRC-RD1003-D32-C32-L250-Z02	●	32	2	32	250	150	5										
AEMRC-RD1003-D33-C32-L160-Z03	●	33	3	32	160	70	5										
AEMRC-RD1003-D40-W32-L150-Z04	●	40	4	32	150	35	5										
AEMRC-RD1003-D40-C32-L250-Z02	●	40	2	32	250	50	5										
new AEMR-RD10T3-D20-C20-L180-Z02-H	●	20	2	20	180	60	5						RD.. 10T3	4015-M3.5x9	ACK-15	4015-M3.5x11	80-T15
AEMRC-RD10T3-D20-C20-L150-Z02	●	20	2	20	150	60	5										
AEMRC-RD10T3-D20-W20-L150-Z02	●	20	2	20	150	60	5										
new AEMRC-RD10T3-D21-C20-L200-Z02-H	●	21	2	20	200	80	5										
AEMRC-RD10T3-D25-C25-L150-Z02	●	25	2	25	150	60	5										
AEMRC-RD10T3-D25-C25-L200-Z02-H	●	25	2	25	200	100	5										
new AEMRC-RD10T3-D25-C32-L150-Z03	●	25	3	32	150	50	5										
AEMRC-RD10T3-D25-W25-L150-Z02	●	25	2	25	150	60	5										
new AEMRC-RD10T3-D26-C25-L200-Z02-H	●	26	2	25	200	35	5										
AEMRC-RD10T3-D32-C25-L250-Z03-H	●	32	3	25	250	35	5										
AEMRC-RD10T3-D32-W32-L150-Z03	●	32	3	32	150	60	5										
new AEMRC-RD10T3-D32-C32-L150-Z04	●	32	4	32	150	60	5										
AEMRC-RD12T3-D25-W25-L150-Z02	●	25	2	25	150	60	6	RD.. 12T3									
AEMRC-RD12T3-D25-W25-L200-Z02	●	25	2	25	200	100	6										
AEMRC-RD12T3-D25-C25-L250-Z02	●	25	2	25	250	150	6										
AEMRC-RD12T3-D25-C25-L300-Z02	●	25	2	25	300	200	6										
AEMRC-RD12T3-D32-W32-L150-Z03	●	32	3	32	150	60	6										
AEMRC-RD12T3-D32-C32-L250-Z02	●	32	2	32	250	150	6										
AEMRC-RD12T3-D40-W32-L150-Z04	●	40	4	32	150	50	6										
AEMRC-RD12T3-D40-C32-L250-Z02	●	40	2	32	250	50	6										
new AEMRC-RD1204-D32-C32-L200-Z02	●	32	2	32	200	100	6	RD.. 1204									
AEMRC-RD1204-D32-C32-L160-Z03	●	32	3	32	160	70	6										
AEMRC-RD1204-D32-W32-L160-Z03	●	32	3	32	160	70	6										
AEMRC-RD1204-D33-C32-L160-Z03	●	33	3	32	160	70	6										
new AEMRC-RD1204-D32-C32-L160-Z03-H	●	32	3	32	160	70	6	RD.. 1604	4015-M4.5x11	ACK-05	4015-M4x11						
AEMRC-RD1604-D40-W32-L150-Z02	●	40	2	32	150	35	8										

R: Sağ / Right / Rechts/ L: Sol / Left / Links

● Stokta / In Stock / Auf Lager ○ Stokta Yok / Non Stock Item / Kein Lagerartikel, Lieferzeit auf Anfrage  
ISO Ucuuna Uygundur. / Compatible with ISO Insert. / Kompatibel mit ISO Wendeplatten.

Sipariş Örneği/Ordering Example/Bestellbeispiel

1 ad./pcs./шт. AEMR-RD0501-D08-W10-L100-Z01-H

Kesme Hesabı : S 377/ Cutting Calculation : P 377 / Schnittberechnung : P 377

**S-SİSTEM YÜZEY ve KOPYA PARMAK FREZELER**  
**S-SYSTEM FACE and COPY END MILLS**  
**S-SYSTEM KOPIER- UND SCHAFTFRÄSER**

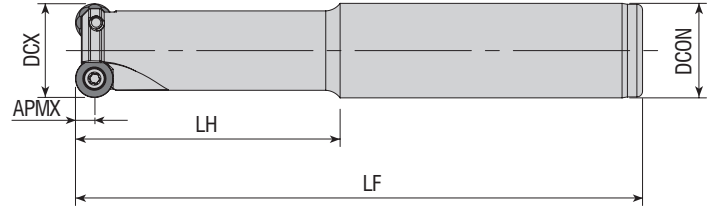

Takım Kodu Ordering Code Bestell-Bezeichnung	Stok Stock Lager	Takım Ölçüleri (mm) Dimension (mm) Abmessung (mm)						Kesici Uç Insert Wendeschneidplatte	Yedek Parçaları / Spare Parts / Ersatzteile			
		DCX	ZEFP	DCON	LF	LH	APMX		Sıkma Vidası Screw Schraube	Baskı Parçası Wedge Clamp Spannpratze	Baskı Vidası Clamp Screw Schraube	Tork Anahtar Torx Key Torx-Schlüssel
AEMR-QP10T3-D20-C20-L150-Z01-H	●	20	1	20	150	70	5	QP. 10T3..	4015-M3.5x9	-	-	80-T15
AEMR-QP10T3-D25-C25-L120-Z02-H	●	25	2	25	120	40	5					
AEMR-QP10T3-D25-C25-L150-Z02-H	●	25	2	25	150	70	5					
AEMR-QP10T3-D25-C25-L170-Z02	●	25	2	25	170	90	5					
AEMR-QP10T3-D32-C32-L150-Z03-H	●	32	3	32	150	70	5					
AEMR-QP10T3-D32-C32-L170-Z03	●	32	3	32	170	90	5					
AEMR-QP1204-D25-C25-L150-Z02-H	●	25	2	25	150	70	6	QP. 1204..	4015-M4x9	-	-	

SMTM Ucuna Uygundur. / Compatible with SMTM Insert. / Kompatibel mit SMTM Wendeplatten.

**S-SİSTEM HIZLI İLERLEMELİ PARMAK FREZELER**  
**S-SYSTEM HIGHFEED END MILLS**  
**S-SYSTEM HOCHVORSCHUB- SCHAFTFRÄSER**

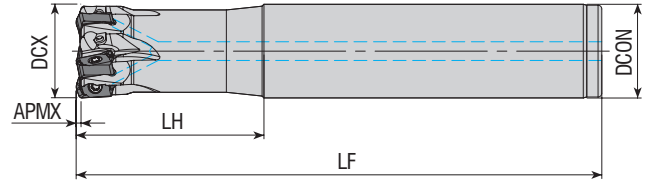

Takım Kodu Ordering Code Bestell-Bezeichnung	Stok Stock Lager	Takım Ölçüleri (mm) Dimension (mm) Abmessung (mm)						Kesici Uç Insert Wendeschneidplatte	Yedek Parçaları / Spare Parts / Ersatzteile	
		DCX	ZEFP	DCON	LF	LH	APMX		Sıkma Vidası Screw Schraube	Tork Anahtar Torx Key Torx-Schlüssel
AHFM-BN10T3-D16-C16-L100-Z02-H	●	16	2	16	100	30	1	BNGX 10T3..	3008-M2.5x6	82-T08
AHFM-BN10T3-D16-C16-L150-Z02-H	●	16	2	16	150	50	1			
AHFM-BN10T3-D20-C20-L130-Z03-H	●	20	3	20	130	40	1			
AHFM-BN10T3-D20-C20-L130-Z04-H	●	20	4	20	130	40	1			
AHFM-BN10T3-D20-C20-L160-Z03-H	●	20	3	20	160	80	1			
AHFM-BN10T3-D25-C25-L140-Z04-H	●	25	4	25	140	50	1			
AHFM-BN10T3-D25-W25-L140-Z04-H	●	25	4	25	140	50	1			
AHFM-BN10T3-D25-C25-L140-Z05-H	●	25	5	25	140	50	1			
AHFM-BN10T3-D25-C25-L180-Z04-H	●	25	4	25	180	100	1			
AHFM-BN10T3-D32-C32-L150-Z05-H	●	32	5	32	150	70	1			
AHFM-BN10T3-D32-C32-L150-Z06-H	●	32	6	32	150	70	1			
AHFM-BN10T3-D35-C32-L200-Z06-H	●	35	6	32	200	50	1			

R: Sağ / Right / Rechts/ L: Sol / Left / Links

● Stokta / In Stock / Auf Lager ○ Stokta Yok / Non Stock Item / Kein Lagerartikel, Lieferzeit auf Anfrage

PRMT Ucuna Uygundur. / Compatible with PRMT Insert. / Kompatibel mit PRMT Wendeplatten.

Sipariş Örneği/Ordering Example/Bestellbeispiel



1 ad./pcs./stück AEMR-QP10T3-D20-C20-L150-Z01-H

Kesme Hesabı : S 377/ Cutting Calculation : P 377 / Schnittberechnung : P 377



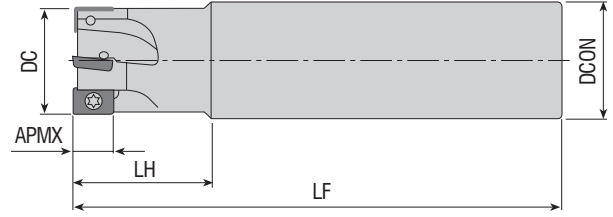

www.akkо.com.tr

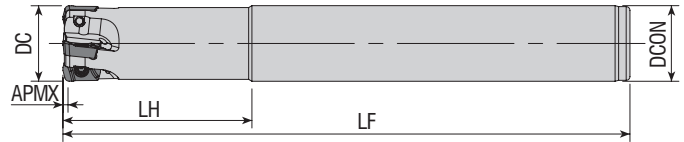

Takım Kodu Ordering Code Bestell-Bezeichnung	Stok Stock Lager	Takım Ölçüleri (mm) Dimension (mm) Abmessung (mm)						Kesici Uç Insert Wendeschneidplatte	Yedek Parçaları / Spare Parts / Ersatzteile		
		DC	ZEFP	DCON	LF	LH	APMX		Sıkma Vidası Screw Schraube	Tork Anahtar Torx Key Torx-Schlüssel	
AHFM-E00602-D10-C10-L080-Z02	●	10	2	10	80	20	-	 <b>EO.. 0602..</b> <b>ZOMT 0602..</b>	 3006-M1.8x4	 82-T06	
AHFM-E00602-D10-C09-L120-Z02	●	10	2	9	120	15	-				
AHFM-E00602-D10-C10-L120-Z02	●	10	2	10	120	60	-				
AHFM-E00602-D12-C12-L080-Z02	●	12	2	12	80	20	-				
AHFM-E00602-D12-C12-L080-Z03	●	12	3	12	80	20	-				
AHFM-E00602-D12-C11-L120-Z02	●	12	2	11	120	15	-				
AHFM-E00602-D12-C11-L120-Z03	●	12	3	11	120	15	-				
AHFM-E00602-D12-C12-L120-Z02	●	12	2	12	120	60	-				
AHFM-E00602-D12-C12-L120-Z03	●	12	3	12	120	60	-				
AHFM-E00602-D16-C16-L150-Z04	●	16	4	16	150	60	-				

DJT Ucuna Uygundur. / Compatible with DJT Insert. / Kompatibel mit DJT Wendeplatten.

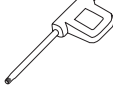

Takım Kodu Ordering Code Bestell-Bezeichnung	Stok Stock Lager	Takım Ölçüleri (mm) Dimension (mm) Abmessung (mm)						Kesici Uç Insert Wendeschneidplatte	Yedek Parçaları / Spare Parts / Ersatzteile		
		DC	ZEFP	DCON	LF	LH	APMX		Sıkma Vidası Screw Schraube	Tork Anahtar Torx Key Torx-Schlüssel	
<b>new</b> AHFM-EP1003-D16-C16-L80-Z02-H	●	16	2	16	80	20	1	 <b>EP. 1003..</b> <b>ZPMT 1003..</b> <b>YPHW 1003..</b>	 3008-M2.5x5	 82-T08	
AHFM-EP1003-D16-C16-L150-Z02-H	●	16	2	16	150	50	1				
AHFM-EP1003-D17-C16-L150-Z02-H	●	17	2	16	150	20	1				
AHFM-EP1003-D20-C20-L150-Z04-H	●	20	4	20	150	50	1				
AHFM-EP1003-D21-C20-L150-Z04-H	●	21	4	20	150	20	1				
AHFM-EP1003-D25-C25-L200-Z04-H	●	25	4	25	200	100	1				
AHFM-EP1003-D25-C25-L250-Z04-H	●	25	4	25	250	100	1				

R: Sağ / Right / Rechts! L: Sol / Left / Links

● Stokta / In Stock / Auf Lager ○ Stokta Yok / Non Stock Item / Kein Lagerartikel, Lieferzeit auf Anfrage

DJT Ucuna Uygundur. / Compatible with DJT Insert. / Kompatibel mit DJT Wendeplatten.



Sipariş Örneği/Ordering Example/Bestellbeispiel

1 ad./pcs./stück AHFM-E00602-D10-C10-L080-Z02

Kesme Hesabı : S 377/ Cutting Calculation : P 377 / Schnittberechnung : P 377

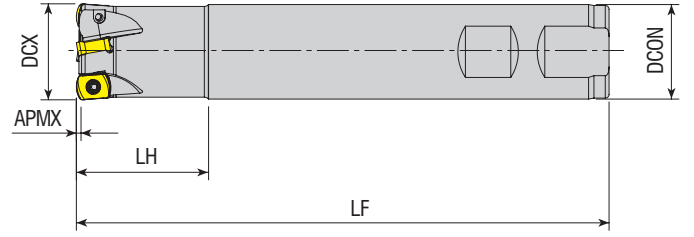
**S-SİSTEM HIZLI İLERLEMELİ PARMAK FREZELER**  
**S-SYSTEM HIGHFEED END MILLS**  
**S-SYSTEM HOCHVORSCHUB- SCHAFTFRÄSER**



Takım Kodu Ordering Code Bestell-Bezeichnung	Stok Stock Lager	Takım Ölçüleri (mm) Dimension (mm) Abmessung (mm)						Kesici Uç Insert Wendeschneidplatte	Yedek Parçaları / Spare Parts / Ersatzteile		
		DCX	ZEFP	DCON	LF	LH	APMX		Sıkma Vidası Screw Schraube	Tork Anahtar Torx Key Torx-Schlüssel	
AHFM-BL0603-D16-C15-L150-Z02	●	16	2	15	150	20	1				
AHFM-BL0603-D16-C16-L100-Z02-H	●	16	2	16	100	30	1				
AHFM-BL0603-D16-C16-L150-Z02	●	16	2	16	150	50	1				
AHFM-BL0603-D17-C16-L150-Z02	●	17	2	16	150	20	1				
AHFM-BL0603-D17-W16-L170-Z02	●	17	2	16	170	20	1				
AHFM-BL0603-D17-W16-L170-Z02-H	●	17	2	16	170	20	1				
AHFM-BL0603-D17-C16-L200-Z02	●	17	2	16	200	30	1				
AHFM-BL0603-D18-C16-L150-Z02	●	18	2	16	150	20	1				
AHFM-BL0603-D18-W16-L150-Z02-H	●	18	2	16	150	20	1				
AHFM-BL0603-D20-C20-L130-Z03	●	20	3	20	130	50	1				
AHFM-BL0603-D20-C20-L160-Z03	●	20	3	20	160	50	1				
AHFM-BL0603-D21-C20-L200-Z03	●	21	3	20	200	25	1				
AHFM-BL0603-D21-W20-L200-Z03	●	21	3	20	200	25	1				
AHFM-BL0603-D22-W20-L150-Z03	●	22	3	20	150	20	1				
AHFM-BL0603-D25-C25-L250-Z04	●	25	4	25	250	40	1				
<b>new</b> AHFM-BL0603-D26-C25-L150-Z04	●	26	4	25	150	35	1				
AHFM-BL0603-D26-C25-L200-Z04	●	26	4	25	200	35	1				
AHFM-BL0603-D26-W25-L200-Z04	●	26	4	25	200	35	1				
AHFM-BL0603-D26-C25-L250-Z04	●	26	4	25	250	35	1				
AHFM-BL0603-D32-C32-L150-Z05	●	32	5	32	150	70	1				
AHFM-BL0603-D32-C32-L200-Z05	●	32	5	32	200	120	1				
AHFM-BL0603-D33-C32-L150-Z05	●	33	5	32	150	40	1				
AHFM-BL0603-D33-C32-L200-Z05	●	33	5	32	200	40	1				
AHFM-BL0603-D33-C32-L250-Z05	●	33	5	32	250	40	1				
<b>new</b> AHFM-BL0904-D28-W25-L180-Z03	●	28	3	25	180	30	1.5	<b>BLMP 0904..</b>	3010-M3.5x9	82-T10	

R: Sağ / Right / Rechtsl L: Sol / Left / Links  
● Stokta / In Stock / Auf Lager ○ Stokta Yok / Non Stock Item / Kein Lagerartikel, Lieferzeit auf Anfrage  
TGTC Ucuna Uygunudur. / Compatible with TGTC Insert. / Kompatibel mit TGTC Wendeplatten.

Sipariş Örneği/Ordering Example/Bestellbeispiel  
1 ad./pcs./stück AHFM-BL0603-D16-C15-L150-Z02  
Kesme Hesabı : S 377/ Cutting Calculation : P 377 / Schnittberechnung : P 377



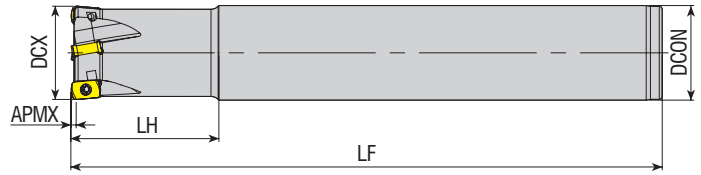

Takım Kodu Ordering Code Bestell-Bezeichnung	Stok Stock Lager	Takım Ölçüleri (mm) Dimension (mm) Abmessung (mm)						Kesici Uç Insert Wendeschneidplatte	Yedek Parçaları / Spare Parts / Ersatzteile		
		DCX	ZEFP	DCON	LF	LH	APMX		Sıkma Vidası Screw Schraube	Tork Anahtar Torx Key Torx-Schlüssel	
AHFM-EN1004-D16-C15-L150-Z02	●	16	2	15	150	25	1	ENMU 1004..	3008-M2.5x6	82-T08	
AHFM-EN1004-D16-C16-L150-Z02	●	16	2	16	150	25	1				
AHFM-EN1004-D16-C16-L250-Z02	●	16	2	16	250	70	1				
AHFM-EN1004-D17-C16-L150-Z02-H	●	17	2	16	150	25	1				
AHFM-EN1004-D17-C16-L150-Z02	●	17	2	16	150	25	1				
AHFM-EN1004-D17-C16-L200-Z02	●	17	2	16	200	25	1				
AHFM-EN1004-D18-C16-L150-Z02	●	18	2	16	150	25	1				
AHFM-EN1004-D20-C20-L150-Z03	●	20	3	20	150	40	1				
AHFM-EN1004-D20-C20-L250-Z03	●	20	3	20	250	70	1				
AHFM-EN1004-D21-C20-L150-Z02	●	21	2	20	150	30	1				
AHFM-EN1004-D21-C20-L150-Z03	●	21	3	20	150	30	1				
AHFM-EN1004-D21-C20-L150-Z03-H	●	21	3	20	150	30	1				
AHFM-EN1004-D21-C20-L200-Z03	●	21	3	20	200	30	1				
AHFM-EN1004-D22-C20-L150-Z03	●	22	3	20	150	30	1				
AHFM-EN1004-D25-C25-L150-Z03	●	25	3	25	150	40	1				
AHFM-EN1004-D25-C25-L150-Z04	●	25	4	25	150	40	1				
AHFM-EN1004-D26-C25-L150-Z03	●	26	3	25	150	30	1				
AHFM-EN1004-D26-C25-L150-Z04	●	26	4	25	150	30	1				
AHFM-EN1004-D26-C25-L200-Z03	●	26	3	25	200	30	1				
AHFM-EN1004-D26-C25-L200-Z03-H	●	26	3	25	200	30	1				
AHFM-EN1004-D26-C25-L250-Z03-H	●	26	3	25	250	30	1				
AHFM-EN1004-D28-C25-L200-Z04	●	28	4	25	200	30	1				
AHFM-EN1004-D32-C32-L200-Z04	●	32	4	32	200	50	1				
AHFM-EN1004-D33-C32-L200-Z04	●	33	4	32	200	30	1				
AHFM-EN1004-D33-C32-L200-Z04-H	●	33	4	32	200	30	1				

R: Sağ / Right / Rechts! L: Sol / Left / Links

● Stokta / In Stock / Auf Lager ○ Stokta Yok / Non Stock Item / Kein Lagerartikel, Lieferzeit auf Anfrage

DJT Ucuna Uygun. / Compatible with DJT Insert. / Kompatibel mit DJT Wendepalten.

Sipariş Örneği/Ordering Example/Bestellbeispiel

1 ad./pcs./stück AHFM-EN1004-D16-C15-L150-Z02

Kesme Hesabı : S 377/ Cutting Calculation : P 377 / Schnittberechnung : P 377



**S-SİSTEM HIZLI İLERLEMELİ PARMAK FREZELER**  
**S-SYSTEM HIGHFEED END MILLS**  
**S-SYSTEM HOCHVORSCHUB- SCHAFTFRÄSER**

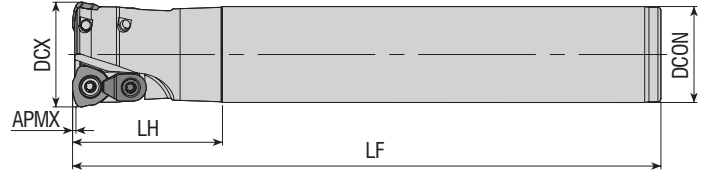

Takım Kodu Ordering Code Bestell-Bezeichnung	Stok Stock Lager	Takım Ölçüleri (mm) Dimension (mm) Abmessung (mm)						Kesici Uç Insert Wendeschneidplatte	Yedek Parçaları / Spare Parts / Ersatzteile			
		DCX	ZEFP	DCON	LF	LH	APMX		Sıkma Vidası Screw Schraube	Baskı Parçası Wedge Clamp Spannpratze	Baskı Vidası Clamp Screw Schraube	Tork Anahtar Torx Key Torx-Schlüssel
AHFMC-JD1204-D32-C32-L150-Z02	●	32	2	32	150	50	1	JDMW 1204..	4615-M4x11	ACK-05	4015-M4x11	80-T15
AHFMC-JD1204-D32-C32-L200-Z02	●	32	2	32	200	50	1					
AHFMC-JD1204-D35-C32-L200-Z02	●	35	2	32	200	50	1					
AHFMC-JD1204-D35-C32-L250-Z02	●	35	2	32	250	50	1					

MTSBH Ucuna Uygunur. / Compatible with MTSBHInsert. / Kompatibel mit MTSBH Wendeplatten.

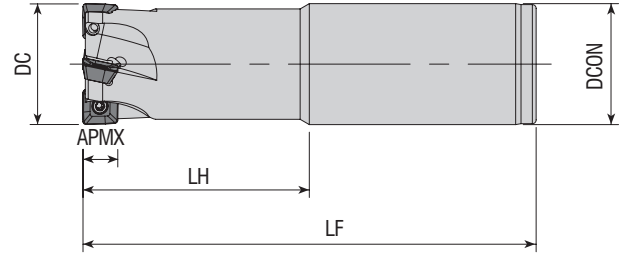

Takım Kodu Ordering Code Bestell-Bezeichnung	Stok Stock Lager	Takım Ölçüleri (mm) Dimension (mm) Abmessung (mm)						Kesici Uç Insert Wendeschneidplatte	Yedek Parçaları / Spare Parts / Ersatzteile	
		DCX	ZEFP	DCON	LF	LH	APMX		Sıkma Vidası Screw Schraube	Tork Anahtar Torx Key Torx-Schlüssel
AHFM-SP0735-D16-C16-L160-Z02-H	●	16	2	16	160	30	1.2	SPMX 073505	3108-M3x6	82-T08
AHFM-SP0735-D17-C16-L160-Z02-H	●	17	2	16	160	30	1.2			
AHFM-SP0735-D20-C20-L160-Z03-H	●	20	2	20	160	30	1.2			
AHFM-SP0735-D21-C20-L160-Z03-H	●	21	2	20	160	30	1.2			

R: Sağ / Right / Rechts! L: Sol / Left / Links  
● Stokta / In Stock / Auf Lager ○ Stokta Yok / Non Stock Item / Kein Lagerartikel, Lieferzeit auf Anfrage  
MTSBH Ucuna Uygunur. / Compatible with MTSBH Insert. / Kompatibel mit MTSBH Wendeplatten.

Sipariş Örneği/Ordering Example/Bestellbeispiel  
1 ad./pcs./stück AHFMC-JD1204-D32-C32-L150-Z02  
Kesme Hesabı : S 377/ Cutting Calculation : P 377 / Schnittberechnung : P 377

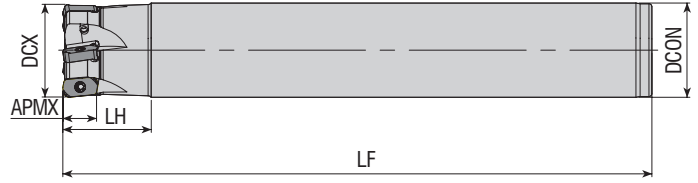

Takım Kodu Ordering Code Bestell-Bezeichnung	Stok Stock Lager	Takım Ölçüleri (mm) Dimension (mm) Abmessung (mm)						Kesici Uç Insert Wendeschneidplatte	Yedek Parçaları / Spare Parts / Ersatzteile		
		DCX	ZEFP	DCON	LF	LH	APMX		Sıkma Vidası Screw Schraube	Tork Anahtar Torx Key Torx-Schlüssel	
AHFM-LN0303-D16-C15-L150-Z02	●	16	2	15	150	30	12	LNMU 0303..	3008-M2.5x6	82-T08	
AHFM-LN0303-D16-W16-L150-Z02-H	●	16	2	16	150	50	12				
<b>new</b> AHFM-LN0303-D17-C16-L150-Z02-H	●	17	2	16	150	30	12				
AHFM-LN0303-D20-W20-L150-Z03-H	●	20	3	20	150	50	12				
AHFM-LN0303-D21-C20-L150-Z03	●	21	3	20	150	30	12				
AHFM-LN0303-D25-W25-L150-Z04-H	●	25	4	25	150	50	12				
AHFM-LN0303-D26-C25-L150-Z04	●	26	4	25	150	30	12				
<b>new</b> AHFM-LN0303-D28-C25-L180-Z03	●	28	3	25	180	30	12				
AHFM-LN0303-D33-C32-L200-Z05	●	33	5	32	200	30	12				

TNGLY Ucuna Uygun. / Compatible with TNGLY Insert. / Kompatibel mit TNGLY Wendeplatten.

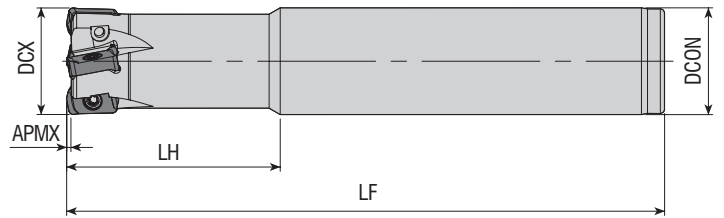

Takım Kodu Ordering Code Bestell-Bezeichnung	Stok Stock Lager	Takım Ölçüleri (mm) Dimension (mm) Abmessung (mm)						Kesici Uç Insert Wendeschneidplatte	Yedek Parçaları / Spare Parts / Ersatzteile		
		DCX	ZEFP	DCON	LF	LH	APMX		Sıkma Vidası Screw Schraube	Tork Anahtar Torx Key Torx-Schlüssel	
AHFM-L003-D16-C15-L160-Z02	●	16	2	15	160	30	1	LOGU 0303..	1108-M3x6.8	82-T08	
AHFM-L003-D16-C16-L100-Z02-F	●	16	2	16	100	30	1				
AHFM-L003-D16-C16-L100-Z02	●	16	2	16	100	30	1				
AHFM-L003-D16-C16-L130-Z02-H	●	16	2	16	130	40	1				
AHFM-L003-D16-C16-L160-Z02	●	16	2	16	160	50	1				
AHFM-L003-D16-C16-L160-Z02-H	●	16	2	16	160	100	1				
AHFM-L003-D17-C16-L180-Z02	●	17	2	16	180	30	1				
AHFM-L003-D20-C20-L130-Z03	●	20	3	20	130	40	1				
AHFM-L003-D20-C20-L130-Z03-H	●	20	3	20	130	40	1				
AHFM-L003-D20-C20-L160-Z03	●	20	3	20	160	80	1				
AHFM-L003-D20-C20-L160-Z03-H	●	20	3	20	160	100	1				
AHFM-L003-D21-C20-L150-Z03-H	●	21	3	20	150	30	1				
AHFM-L003-D21-C20-L200-Z03	●	21	3	20	200	30	1				
AHFM-L003-D21-C20-L200-Z03-H	●	21	3	20	200	30	1				
AHFM-L003-D25-C25-L140-Z04-F	●	25	4	25	140	50	1				
AHFM-L003-D25-C25-L140-Z04	●	25	4	25	140	50	1				
AHFM-L003-D25-C25-L180-Z04	●	25	4	25	180	100	1				
AHFM-L003-D26-C25-L250-Z04	●	26	4	25	250	40	1				
AHFM-L003-D32-C32-L200-Z05	●	32	5	32	200	120	1				
AHFM-L003-D33-C32-L250-Z05	●	33	5	32	250	40	1				

R: Sağ / Right / Rechts/ L: Sol / Left / Links

● Stokta / In Stock / Auf Lager ○ Stokta Yok / Non Stock Item / Kein Lagerartikel, Lieferzeit auf Anfrage

KYCR Ucuna Uygun. / Compatible with KYCR Insert. / Kompatibel mit KYCR Wendeplatten.

F: Eksenel ve Radyal Salgı Değeri 0,02 mm içindedir. / F: Axial and Radial Runout Value is within 0,02 mm.

F: Der axiale und radiale Rundlaufwert liegt innerhalb von 0,02 mm.

Sipariş Örneği/Ordering Example/Bestellbeispiel

1 ad./pcs./stück AHFM-LN0303-D16-C15-L150-Z02

Kesme Hesabı : S 377/ Cutting Calculation : P 377 / Schnittberechnung : P 377

# S-SİSTEM HIZLI İLERLEMELİ PARMAK FREZELER

S-SYSTEM HIGHFEED END MILLS

S-SYSTEM HOCHVORSCHUB- SCHAFTFRÄSER

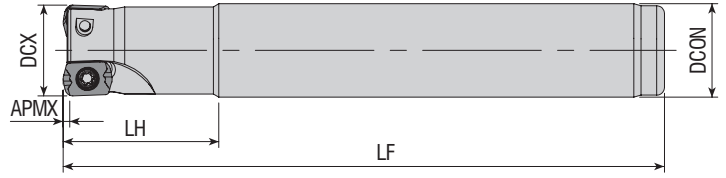

Takım Kodu Ordering Code Bestell-Bezeichnung	Stok Stock Lager	Takım Ölçüleri (mm) Dimension (mm) Abmessung (mm)						Kesici Uç Insert Wendeschneidplatte	Yedek Parçaları / Spare Parts / Ersatzteile		
		DCX	ZEFP	DCON	LF	LH	APMX		Sıkma Vidası Screw Schraube	Tork Anahtar Torx Key Torx-Schlüssel	
AHFM-LP0102-D10-C09-L120-Z02	●	10	2	9	120	20	0.5	LPGT 0102..	3006-M1.8x4	82-T06	
AHFM-LP0102-D10-C10-L120-Z02	●	10	2	10	120	20	0.5				
AHFM-LP0102-D12-C11-L120-Z02	●	12	2	11	120	20	0.5				
AHFM-LP0102-D12-C12-L120-Z02	●	12	2	12	120	20	0.5				

KYCR Ucuna Uygunur. / Compatible with KYCR Insert. / Kompatibel mit KYCR Wendeplatten.

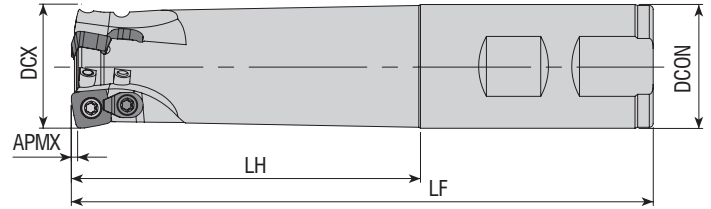

Takım Kodu Ordering Code Bestell-Bezeichnung	Stok Stock Lager	Takım Ölçüleri (mm) Dimension (mm) Abmessung (mm)						Kesici Uç Insert Wendeschneidplatte	Yedek Parçaları / Spare Parts / Ersatzteile			
		DCX	ZEFP	DCON	LF	LH	APMX		Sıkma Vidası Screw Schraube	Baskı Parçası Wedge Clamp Spannpratze	Baskı Vidası Clamp Screw Schraube	Tork Anahtar Torx Key Torx-Schlüssel
AHFM-SD06T2-D16-C16-L100-Z02-H	●	16	2	16	100	50	0.8	SD.. 06T2..	3007-M2.2x4.6	-	-	82-T07
AHFM-SD06T2-D16-C16-L150-Z02-H	●	16	2	16	150	50	0.8					
AHFM-SD06T2-D16-C16-L200-Z02	●	16	2	16	200	100	0.8					
AHFM-SD06T2-D17-C16-L150-Z02-H	●	17	2	16	150	50	0.8					
AHFM-SD06T2-D20-C20-L150-Z03-H	●	20	3	20	150	50	0.8					
AHFM-SD06T2-D20-C20-L200-Z03	●	20	3	20	200	100	0.8					
AHFM-SD06T2-D21-C20-L150-Z03-H	●	21	3	20	150	50	0.8					
AHFM-SD06T2-D25-C25-L150-Z04-H	●	25	4	25	150	60	0.8					
AHFM-SD06T2-D26-C25-L150-Z04-H	●	26	4	25	150	60	0.8					
AHFMC-SD09T3-D22-W20-L150-Z02	●	22	2	20	150	30	1.4					
AHFMC-SD09T3-D25-C25-L150-Z02	●	25	2	25	150	94	1.4					
AHFMC-SD09T3-D25-W25-L150-Z02	●	25	2	25	150	94	1.4					
AHFMC-SD09T3-D28-C25-L150-Z02	●	28	2	25	150	30	1.4					
AHFMC-SD09T3-D32-C32-L150-Z03	●	32	3	32	150	100	1.4					
AHFMC-SD09T3-D32-W32-L150-Z03	●	32	3	32	150	90	1.4					
AHFMC-SD09T3-D25-C25-L150-Z03	●	25	3	25	150	60	1.4					
AHFMC-SD09T3-D32-C32-L150-Z04	●	32	4	25	150	60	1.4					

R: Sağ / Right / Rechts L: Sol / Left / Links

● Stokta / In Stock / Auf Lager ○ Stokta Yok / Non Stock Item / Kein Lagerartikel, Lieferzeit auf Anfrage  
ZCC Ucuna Uygunur. / Compatible with ZCC Insert. / Kompatibel mit ZCC Wendeplatten.

Sipariş Örneği/Ordering Example/Bestellbeispiel

1 ad./pcs./stück AHFM-LP0102-D10-C09-L120-Z02

Kesme Hesabı : S 377/ Cutting Calculation : P 377 / Schnittberechnung : P 377



www.akkо.com.tr

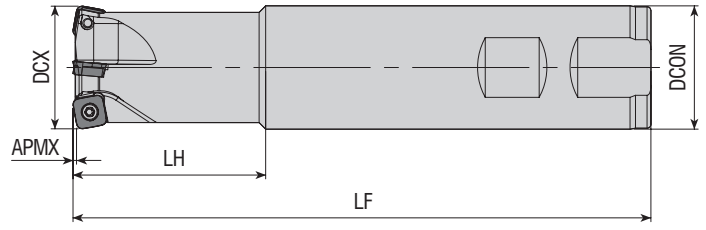

Takım Kodu Ordering Code Bestell-Bezeichnung	Stok Stock Lager	Takım Ölçüleri (mm) Dimension (mm) Abmessung (mm)						Kesici Uç Insert Wendeschneidplatte	Yedek Parçaları / Spare Parts / Ersatzteile		
		DCX	ZEFP	DCON	LF	LH	APMX		Sıkma Vidası Screw Schraube	Tork Anahtar Torx Key Torx-Schlüssel	
AHFM-S00803-D20-W20-L150-Z02	●	20	2	20	150	50	-	SOMW 0803..		4010-M3x8	
AHFM-S00803-D25-W25-L150-Z03	●	25	3	25	150	50	-				
AHFM-S00803-D32-W32-L150-Z04	●	32	4	32	150	50	-				

KPTK Ucuna Uygun. / Compatible with KPTK Insert. / Kompatibel mit KPTK Wendepfatten.

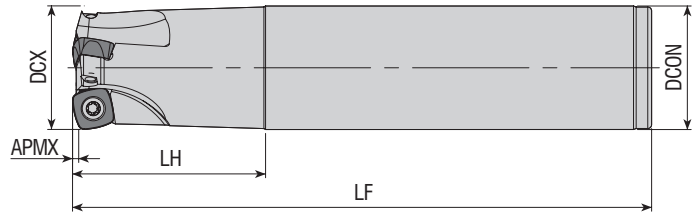

Takım Kodu Ordering Code Bestell-Bezeichnung	Stok Stock Lager	Takım Ölçüleri (mm) Dimension (mm) Abmessung (mm)						Kesici Uç Insert Wendeschneidplatte	Yedek Parçaları / Spare Parts / Ersatzteile		
		DCX	ZEFP	DCON	LF	LH	APMX		Sıkma Vidası Screw Schraube	Tork Anahtar Torx Key Torx-Schlüssel	
AHFM-SP1004-D25-C25-L150-Z02	●	25	2	25	150	50	1.5	SPNW 1004..		3015-M3.5x9	
AHFM-SP1004-D32-C32-L150-Z03	●	32	3	32	150	50	1.5				

R: Sağ / Right / Rechts/ L: Sol / Left / Links

● Stokta / In Stock / Auf Lager ○ Stokta Yok / Non Stock Item / Kein Lagerartikel, Lieferzeit auf Anfrage  
DJT Ucuna Uygun. / Compatible with DJT Insert. / Kompatibel mit DJT Wendepfatten.

Sipariş Örneği/Ordering Example/Bestellbeispiel

1 ad./pcs./stück AHFM-S00803-D20-W20-L150-Z02

Kesme Hesabı : S 377/ Cutting Calculation : P 377 / Schnittberechnung : P 377

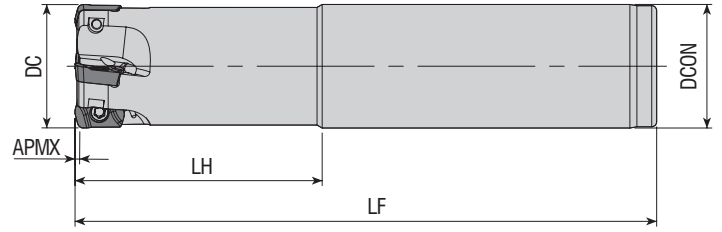

Takım Kodu Ordering Code Bestell-Bezeichnung	Stok Stock Lager	Takım Ölçüleri (mm) Dimension (mm) Abmessung (mm)						Kesici Uç Insert Wendeschneidplatte	Yedek Parçaları / Spare Parts / Ersatzteile	
		DC	ZEFP	DCON	LF	LH	APMX		Sıkma Vidası Screw Schraube	Tork Anahtar Torx Key Torx-Schlüssel
AHFM-YP1003-D16-C15-L150-Z02-F	●	16	2	15	150	20	1	EP. 1003.. YPHW 1003.. ZPMT 1003..	3008-M2.5x5	82-T08
AHFM-YP1003-D16-C15-L200-Z02-F	●	16	2	15	200	20	1			
AHFM-YP1003-D16-C16-L150-Z02-F	●	16	2	16	150	50	1			
AHFM-YP1003-D17-C16-L150-Z02-F	●	17	2	16	150	20	1			
AHFM-YP1003-D17-C16-L200-Z02-F	●	17	2	16	200	20	1			
AHFM-YP1003-D20-C18-L150-Z03-F	●	20	3	18	150	25	1			
AHFM-YP1003-D20-C18-L200-Z03-F	●	20	3	18	200	25	1			
AHFM-YP1003-D20-C20-L150-Z03-F	●	20	3	20	150	50	1			
AHFM-YP1003-D21-C20-L150-Z03-F	●	21	3	20	150	20	1			
AHFM-YP1003-D21-C20-L150-Z03-H	●	21	3	20	150	20	1			
AHFM-YP1003-D21-C20-L150-Z04-F	●	21	4	20	150	20	1			
AHFM-YP1003-D21-C20-L200-Z03	●	21	3	20	200	20	1			
AHFM-YP1003-D21-C20-L200-Z03-F	●	21	3	20	200	20	1			
AHFM-YP1003-D25-C20-L150-Z04-F	●	25	4	20	150	25	1			
AHFM-YP1003-D25-C20-L200-Z04-F	●	25	4	20	200	25	1			
AHFM-YP1003-D25-C25-L150-Z04-F	●	25	4	25	150	50	1			
AHFM-YP1003-D26-C25-L150-Z04	●	26	4	25	150	30	1			
<b>new</b> AHFM-YP1003-D25-C25-L150-Z04-H	●	25	4	25	150	50	1			
AHFM-YP1003-D26-C25-L150-Z04-F	●	26	4	25	150	30	1			
<b>new</b> AHFM-YP1003-D26-C25-L250-Z04-F	●	26	4	25	250	30	1			
AHFM-YP1003-D26-C25-L200-Z03-F	●	26	3	25	200	30	1			
AHFM-YP1003-D26-C25-L200-Z04-F	●	26	4	25	200	30	1			
<b>new</b> AHFM-YP1003-D33-C32-L200-Z04-F	●	33	4	32	200	30	1			
<b>new</b> AHFM-YP1003-D33-C32-L250-Z04-F	●	33	4	32	250	30	1			
<b>new</b> AHFM-YP1003-D33-C32-L300-Z04-F	●	33	4	32	300	30	1			

R: Sağ / Right / Rechts/ L: Sol / Left / Links

● Stokta / In Stock / Auf Lager ○ Stokta Yok / Non Stock Item / Kein Lagerartikel, Lieferzeit auf Anfrage

DJT Ucuna Uygunur. / Compatible with DJT Insert. / Kompatibel mit DJT Wendepplatten.

Çap Ölçüsü - 0,02 mm Olarak üretiliyor. F: ± 0,02 mm Demektir. Ör: Ø16 Takım 15,98 ± 0,02 mm yani 16,00 mm - 15,96 mm Olmalıdır.

Diameter Size is produced as - 0,02 mm. F: means ± 0,02 mm. For example: Ø16 tool 15,98 ± 0,02 mm, it means that it should be 16,00 mm - 15,96 mm.

Durchmesser - Es wird mit -0,02 mm hergestellt. Das heißt F: ± 0,02 mm. Zum Beispiel: Der Ø16-Satz sollte 15,98 ± 0,02 mm, 16,00 mm - 15,96 mm betragen.

Sipariş Örneği/Ordering Example/Bestellbeispiel

1 ad./pcs./stück AHFM-YP1003-D16-C15-L150-Z02-F

Kesme Hesabı : S 377/ Cutting Calculation : P 377 / Schnittberechnung : P 377



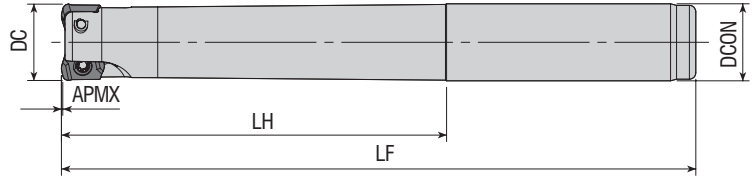

Takım Kodu Ordering Code Bestell-Bezeichnung	Stok Stock Lager	Takım Ölçüleri (mm) Dimension (mm) Abmessung (mm)						Kesici Uç Insert Wendeschneidplatte	Yedek Parçaları / Spare Parts / Ersatzteile		
		DC	ZEFP	DCON	LF	LH	APMX		Sıkma Vidası Screw Schraube	Tork Anahtar Torx Key Torx-Schlüssel	
AHFM-YO0602-D10-C09-L120-Z02-F	●	10	2	9	120	15	0.3	YOHW 0602..	3006-M1.8X4	82-T06	
AHFM-YO0602-D10-C10-L080-Z02-F	●	10	2	10	80	20	0.3				
AHFM-YO0602-D10-C10-L120-Z02-F	●	10	2	10	120	60	0.3				
AHFM-YO0602-D10-C10-L120-Z02-H-F	●	10	2	10	120	60	0.3				
AHFM-YO0602-D10-C10-L120-Z02-H	●	10	2	10	120	60	0.3				
AHFM-YO0602-D12-C11-L120-Z02-F	●	12	2	11	120	15	0.3				
AHFM-YO0602-D12-C11-L120-Z02-H-F	●	12	2	11	120	15	0.3				
AHFM-YO0602-D12-C11-L120-Z02-H	●	12	2	11	120	15	0.3				
AHFM-YO0602-D12-C11-L120-Z03-F	●	12	3	11	120	15	0.3				
AHFM-YO0602-D12-C12-L080-Z02-F	●	12	2	12	80	20	0.3				
AHFM-YO0602-D12-C12-L080-Z03-F	●	12	3	12	80	20	0.3				
AHFM-YO0602-D12-C12-L120-Z02-F	●	12	2	12	120	60	0.3				
AHFM-YO0602-D12-C12-L120-Z02-H	●	12	2	12	120	60	0.3				
AHFM-YO0602-D12-C12-L120-Z03-F	●	12	3	12	120	60	0.3				
AHFM-YO0602-D12-C12-L120-Z03-H	●	12	3	12	120	60	0.3				

DJT Ucuna Uygunudur. / Compatible with DJT Insert. / Kompatibel mit DJT Wendeplatten.

F: Eksenel ve Radyal Salgı Değeri 0,02 mm içindedir. / F: Axial and radial runout value is within 0,02mm // F: Der axiale und radiale Rundlaufwert liegt innerhalb von 0,02 mm.

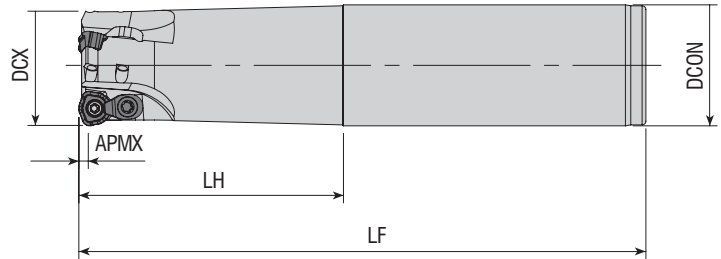

Takım Kodu Ordering Code Bestell-Bezeichnung	Stok Stock Lager	Takım Ölçüleri (mm) Dimension (mm) Abmessung (mm)						Kesici Uç Insert Wendeschneidplatte	Yedek Parçaları / Spare Parts / Ersatzteile			
		DCX	ZEFP	DCON	LF	LH	APMX		Sıkma Vidası Screw Schraube	Baskı Parçası Wedge Clamp Spannpratze	Baskı Vidası Clamp Screw Schraube	Tork Anahtar Torx Key Torx-Schlüssel
AHFM-WD0603-D16-C16-L150-Z02	●	16	2	16	150	70	2	WDMT 0603..	3008-M2.5x6	-	-	82-T08
AHFM-WD0603-D20-C20-L150-Z03	●	20	3	20	150	70	2	WDMT 0603..	3008-M2.5x6	-	-	82-T08
AHFMC-WD0804-D25-C25-L150-Z02	●	25	2	25	150	70	1.5	WDMT 0804..	4010-M3X8	ACK-15	4010-M3x8	82-T10
AHFMC-WD0804-D32-C32-L150-Z03	●	32	3	32	150	70	1.5	WDMT 0804..	4010-M3X8	ACK-15	4010-M3x8	82-T10
AHFMC-WD1205-D32-C32-L150-Z02	●	32	2	32	150	70	3	WDMT 1205..	1415-M4x11	ACK-05	4015-M4x11	80-T15

R: Sağ / Right / Rechts L: Sol / Left / Links

● Stokta / In Stock / Auf Lager ○ Stokta Yok / Non Stock Item / Kein Lagerartikel, Lieferzeit auf Anfrage

SMTM Ucuna Uygunudur. / Compatible with SMTM Insert. / Kompatibel mit SMTM Wendeplatten.

Sipariş Örneği/Ordering Example/Bestellbeispiel

1 ad./pcs./stück AHFM-YO0602-D10-C09-L120-Z02-F

Kesme Hesabı : S 377/ Cutting Calculation : P 377 / Schnittberechnung : P 377

# S-SİSTEM HIZLI İLERLEMELİ PARMAK FREZELER

S-SYSTEM HIGHFEED END MILLS

S-SYSTEM HOCHVORSCHUB- SCHAFTFRÄSER

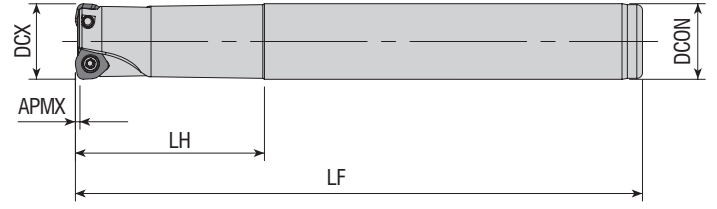

Takım Kodu Ordering Code Bestell-Bezeichnung	Stok Stock Lager	Takım Ölçüleri (mm) Dimension (mm) Abmessung (mm)						Kesici Uç Insert Wendeschneidplatte	Yedek Parçaları / Spare Parts / Ersatzteile			
		DCX	ZEFP	DCON	LF	LH	APMX		Sıkma Vidası Screw Schraube	Baskı Parçası Wedge Clamp Spannpratze	Baskı Vidası Clamp Screw Schraube	Tork Anahtar Torx Key Torx-Schlüssel
AHFM-WD0503D-D20-C20-L150-Z02	●	20	2	20	150	50	1.25	WD.W 0503..	4010-M3x6	-	-	82-T10
AHFM-WD0503D-D21-C20-L150-Z02	●	21	2	20	150	30	1.25					
AHFMC-WD06T3D-D26-C25-L200-Z02	●	26	2	25	200	30	1.5	WD.W 06T3..	3015-M3.5x9	ACK-15	4015-M3.5x11	80-T15
AHFMC-WD06T3D-D33-C32-L200-Z03	●	33	3	32	200	32	1.5					

DJT Ucuna Uygundur. / Compatible with DJT Insert. / Kompatibel mit DJT Wendeplatten.

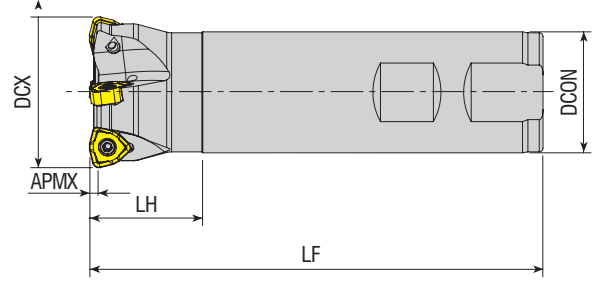

Takım Kodu Ordering Code Bestell-Bezeichnung	Stok Stock Lager	Takım Ölçüleri (mm) Dimension (mm) Abmessung (mm)						Kesici Uç Insert Wendeschneidplatte	Yedek Parçaları / Spare Parts / Ersatzteile	
		DCX	ZEFP	DCON	LF	LH	APMX		Sıkma Vidası Screw Schraube	Tork Anahtar Torx Key Torx-Schlüssel
AHFM-WN0603-D16-C16-L110-Z02-H	●	16	2	16	110	30	1	WNMX 0603..	3008-M2.5x6	82-T08
AHFM-WN0603-D16-C16-L150-Z02-H	●	16	2	16	150	70	1			
AHFM-WN0603-D17-C16-L150-Z02-H	●	17	2	16	150	20	1			
AHFM-WN0603-D20-C20-L150-Z02-H	●	20	2	20	150	70	1			
AHFM-WN0603-D20-C20-L200-Z02-H	●	20	2	20	200	100	1			
AHFM-WN0603-D21-C20-L150-Z02-H	●	21	2	20	150	20	1			
AHFM-WN09T3-D25-W25-L120-Z02-H	●	25	2	25	120	40	1.5	WNMX 09T3..	4010-M3x8	82-T10
AHFML-WN09T3-D25-W25-L120-Z02-H	●	25	2	25	120	40	1.5			
AHFM-WN09T3-D25-C25-L200-Z02	●	25	2	25	200	120	1.5			
AHFM-WN09T3-D32-W32-L120-Z03-H	●	32	3	32	120	30	1.5			
AHFM-WN09T3-D32-W32-L200-Z03-H	○	32	3	32	200	100	1.5			
AHFM-WN09T3-D35-W32-L200-Z04-H	●	35	4	32	200	50	1.5			
AHFM-WN09T3-D40-W32-L120-Z04-H	●	40	4	32	120	30	1.5	WNMX 1305..	4015-M4x11	80-T15
AHFM-WN09T3-D40-C32-L200-Z04	●	40	4	32	200	30	1.5			
AHFM-WN1305-D32-C32-L150-Z02-H	○	32	2	32	150	70	2			
AHFM-WN1305-D32-C32-L200-Z02-H	●	32	2	32	200	120	2			
AHFM-WN1305-D40-C32-L200-Z03-H	●	40	3	32	200	30	2			

R: Sağ / Right / Rechts/ L: Sol / Left / Links

● Stokta / In Stock / Auf Lager ○ Stokta Yok / Non Stock Item / Kein Lagerartikel, Lieferzeit auf Anfrage

KRYL Ucuna Uygundur. / Compatible with KRYL Insert. / Kompatibel mit KRYL Wendeplatten.

Sipariş Örneği/Ordering Example/Bestellbeispiel

1 ad./pcs./stück AHFM-WD0503D-D20-C20-L150-Z02

Kesme Hesabı : S 377/ Cutting Calculation : P 377 / Schnittberechnung : P 377



www.akko.com.tr



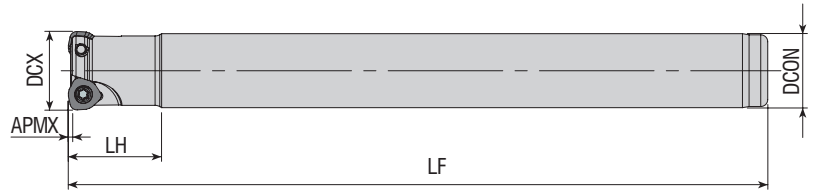

Takım Kodu Ordering Code Bestell-Bezeichnung	Stok Stock Lager	Takım Ölçüleri (mm) Dimension (mm) Abmessung (mm)						Kesici Uç Insert Wendeschneidplatte	Yedek Parçaları / Spare Parts / Ersatzteile		
		DCX	ZEPF	DCON	LF	LH	APMX		Sıkma Vidası Screw Schraube	Tork Anahtar Torx Key Torx-Schlüssel	
AHFM-W004T2D-D16-C16-L150-Z02	●	16	2	16	150	20	0.8	WOMW 04T2..		3008-M2.5x6	
AHFM-W004T2D-D17-C16-L150-Z02	●	17	2	16	150	20	0.8				

DJT Ucuna Uygun. / Compatible with DJT Insert. / Kompatibel mit DJT Wendeplatten.

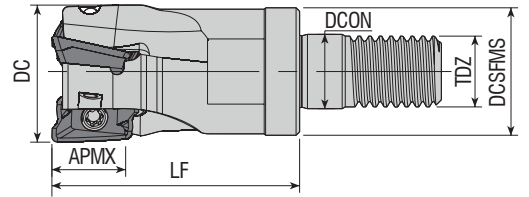

Takım Kodu Ordering Code Bestell-Bezeichnung	Stok Stock Lager	Takım Ölçüleri (mm) Dimension (mm) Abmessung (mm)							Kesici Uç Insert Wendeschneidplatte	Yedek Parçaları / Spare Parts / Ersatzteile		
		DC	Z	DCSFMS	TDZ	LF	DCON	APMX		Sıkma Vidası Screw Schraube	Tork Anahtar Torx Key Torx-Schlüssel	
AEM90-A01236-D16-M08-L30-Z02	●	16	2	14.8	M08	30	8.5	10	A0.. 1236..			
AEM90-A01236-D20-M10-L35-Z03	●	20	3	18	M10	35	10.5	10				

R: Sağ / Right / Rechtsl L: Sol / Left / Links

● Stokta / In Stock / Auf Lager ○ Stokta Yok / Non Stock Item / Kein Lagerartikel, Lieferzeit auf Anfrage  
MTSBH Ucuna Uygun. / Compatible with MTSBH Insert. / Kompatibel mit MTSBH Wendeplatten.

Sipariş Örneği/Ordering Example/Bestellbeispiel

1 ad./pcs./stück AHFM-W004T2D-D16-C16-L150-Z02

Kesme Hesabı : S 377 / Cutting Calculation : P 377 / Schnittberechnung : P 377

Sıkma Tork Değeri : S 376 / Tightening Torque : P 376 / Anzugsmoment : P 376

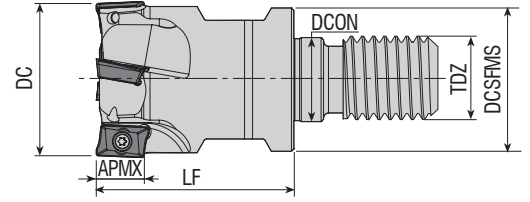

Takım Kodu Ordering Code Bestell-Bezeichnung	Stok Stock Lager	Takım Ölçüleri (mm) Dimension (mm) Abmessung (mm)							Kesici Uç Insert Wendeschneidplatte	Yedek Parçaları / Spare Parts / Ersatzteile	
		DC	ZEP	DCSFMS	TDZ	LF	DCON	APMX		Sıkma Vidası Screw Schraube	Tork Anahtar Torx Key Torx-Schlüssel
AEM90-AD1505D-D25-M12-L43-Z02-H	●	25	2	21	M12	43	12.5	14.3	ADKT 150508	4015-M4x9	80-T15
AEM90-AD1505D-D32-M16-L43-Z03-H	●	32	3	29	M16	43	17	14.3		4015-M4x11	

DJT Ucuna Uygun. / Compatible with DJT Insert. / Kompatibel mit DJT

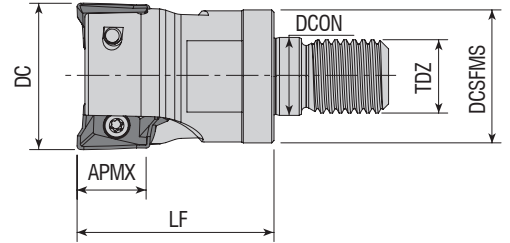

Takım Kodu Ordering Code Bestell-Bezeichnung	Stok Stock Lager	Takım Ölçüleri (mm) Dimension (mm) Abmessung (mm)							Kesici Uç Insert Wendeschneidplatte	Yedek Parçaları / Spare Parts / Ersatzteile	
		DC	ZEP	DCSFMS	TDZ	LF	DCON	APMX		Sıkma Vidası Screw Schraube	Tork Anahtar Torx Key Torx-Schlüssel
AEM90-AX1235-D16-M08-L30-Z02-H	●	16	2	14.75	M08	30	8.5	10	AX.T 1235..	3108-M3x6	82-T08
AEM90-AX1235-D20-M10-L30-Z03-H	●	20	3	18	M10	30	10.5	10		4015-M4x9	
AEM90-AX1235-D25-M12-L35-Z04-H	●	25	4	21	M12	35	12.5	10	AX.T 1705..	4015-M4x9	80-T15
AEM90-AX1705-D25-M12-L43-Z02-H	●	25	2	21	M12	43	12.5	14			
AEM90-AX1705-D32-M16-L43-Z02-H	●	32	2	29	M16	43	17	14			

R: Sağ / Right / Rechts/ L: Sol / Left / Links

● Stokta / In Stock / Auf Lager ○ Stokta Yok / Non Stock Item / Kein Lagerartikel, Lieferzeit auf Anfrage  
SMTM Ucuna Uygun. / Compatible with SMTM Insert. / Kompatibel mit SMTM Wendeplatten.

Sipariş Örneği/Ordering Example/Bestellbeispiel

1 ad./pcs./stück AEM90-AD1505D-D25-M12-L43-Z02-H

Kesme Hesabı : S 377/ Cutting Calculation : P 377 / Schnittberechnung : P 377  
Sıkma Tork Değeri : S 376 / Tightening Torque : P 376 / Anzugsmoment : P 376



KAPR=90°

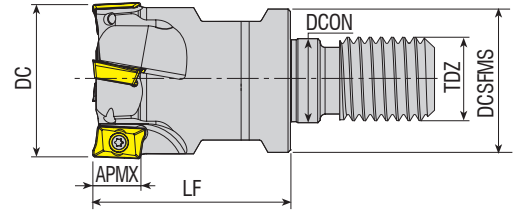

Takım Kodu Ordering Code Bestell-Bezeichnung	Stok Stock Lager	Takım Ölçüleri (mm) Dimension (mm) Abmessung (mm)							Kesici Uç Insert Wendeschneidplatte	Yedek Parçaları / Spare Parts / Ersatzteile	
		DC	ZEFP	DCSFMS	TDZ	LF	DCON	APMX		Sıkma Vidası Screw Schraube	Tork Anahtar Torx Key Torx-Schlüssel
AEM90-AP0903-D20-M12-L35-Z03	●	20	3	18	M12	35	12.5	9	APMT 0903.. KRYL UCUNA UYGUNDUR. FOR KRYL INSERT. Kompatibel mit KRYL.	3008-M2.5x6	82-T08
AEM90-AP0903-D25-M12-L35-Z03	●	25	3	21	M12	35	12.5	9			
AEM90-AP10-D16-M08-L30-Z02-H	●	16	2	14.75	M08	30	8.5	10	AP. 1003.. ISO UCUNA UYGUNDUR. FOR ISO INSERT. Kompatibel mit ISO	3008-M2.5x6	82-T08
AEM90-AP10-D20-M10-L30-Z03-H	●	20	3	18	M10	30	10.5	10			
AEM90-AP10-D25-M12-L35-Z03-H	●	25	3	21	M12	35	12.5	10			
AEM90-AP10-D32-M16-L35-Z04-H	●	32	4	29	M16	35	17	10			
AEM90-AP10-D32-M16-L40-Z04-H	●	32	4	29	M16	40	17	10			
AEM90-AP10-D40-M16-L43-Z05-H	●	40	5	29	M16	43	17	10			
AEM90-AP10-D42-M16-L43-Z05-H	●	42	5	29	M16	43	17	10			
AEM90-AP10D-D16-M08-L30-Z02-H	●	16	2	14.75	M08	30	8.5	10			
AEM90-AP10D-D20-M10-L30-Z03-H	●	20	3	18	M10	30	10.5	10	AP. 1003.. DJT UCUNA UYGUNDUR. FOR DJT INSERT. Kompatibel mit DJT	3008-M2.5x6	82-T08
AEM90-AP10D-D25-M12-L35-Z03-H	●	25	3	21	M12	35	12.5	10			
AEM90-AP11-D16-M08-L30-Z02-H	●	16	2	14.75	M08	30	8.5	11	AP. 11T3.. ZCC UCUNA UYGUNDUR. FOR ZCC INSERT. Kompatibel mit ZCC Wendeplatten.	3008-M2.5x6	82-T08
AEM90-AP11-D20-M10-L30-Z03-H	●	20	3	18	M10	30	10.5	11			
AEM90-AP11-D25-M12-L35-Z03-H	●	25	3	21	M12	35	12.5	11			
AEM90-AP11-D32-M16-L35-Z04-H	●	32	4	29	M16	35	17	11			
AEM90-AP11-D40-M16-L43-Z05-H	●	40	5	29	M16	43	17	11	AP. 1604.. ISO UCUNA UYGUNDUR. FOR ISO INSERT. Kompatibel mit ISO	4015-M4x9	80-T15
AEM90-AP16-D25-M12-L43-Z02-H	●	25	2	21	M12	43	12.5	16			
AEM90-AP16-D32-M16-L43-Z03-H	●	32	3	29	M16	43	17	16			
AEM90-AP16-D40-M16-L43-Z04-H	●	40	4	29	M16	43	17	16			
AEM90-AP16-D42-M16-L43-Z04-H	●	42	4	29	M16	43	17	16	AP. 1604.. DJT UCUNA UYGUNDUR. FOR DJT INSERT. Kompatibel mit DJT	4015-M4x9	80-T15
AEM90-AP16DJ-D25-M12-L43-Z02-H	●	25	2	21	M12	43	12.5	16			
AEM90-AP16DJ-D32-M16-L43-Z03-H	●	32	3	29	M16	43	17	16			
AEM90-AP16DJ-D40-M16-L43-Z04-H	●	40	4	29	M16	43	17	16	AP. 1604.. LMN UCUNA UYGUNDUR. FOR LMN INSERT. Kompatibel mit LMN	4015-M4x9	80-T15
AEM90-AP16L-D25-M12-L43-Z02-H	●	25	2	21	M12	43	12.5	16			
AEM90-AP16L-D32-M16-L43-Z03-H	●	32	3	29	M16	43	17	16			
AEM90-AP16L-D40-M16-L43-Z04-H	●	40	4	29	M16	43	17	16	AP. 1604.. LMN UCUNA UYGUNDUR. FOR LMN INSERT. Kompatibel mit LMN	4015-M4x9	80-T15

R: Sağ / Right / Rechtsl L: Sol / Left / Links

● Stokta / In Stock / Auf Lager ○ Stokta Yok / Non Stock Item / Kein Lagerartikel, Lieferzeit auf Anfrage

Sipariş Örneği/Ordering Example/Bestellbeispiel

1 ad./pcs./stück AEM90-AP0903-D20-M12-L35-Z03

Kesme Hesabı : S 377/ Cutting Calculation : P 377 / Schnittberechnung : P 377

Sıkma Tork Değeri : S 376 / Tightening Torque : P 376 / Anzugsmoment : P 376

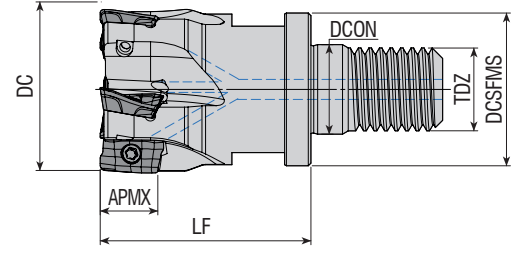

Takım Kodu Ordering Code Bestell-Bezeichnung	Stok Stock Lager	Takım Ölçüleri (mm) Dimension (mm) Abmessung (mm)							Kesici Uç Insert Wendeschneidplatte	Yedek Parçaları / Spare Parts / Ersatzteile	
		DC	ZEFP	DCSFMS	TDZ	LF	DCON	APMX		Sıkma Vidası Screw Schraube	Tork Anahtar Torx Key Torx-Schlüssel
AEM90-BD11T3-D16-M08-L25-Z02-H	●	16	2	14.75	M08	25	8.5	10	BDMT 11T3..	3008-M2.5x6	82-T08
AEM90-BD11T3-D25-M12-L35-Z04-H	●	25	4	21	M12	35	12.5	10			
AEM90-BD11T3-D32-M16-L40-Z05-H	●	32	5	29	M16	40	17	10			

KYCR Ucuna Uygun. / Compatible with KYCR Insert. / Kompatibel mit KYCR Wendeplatten.

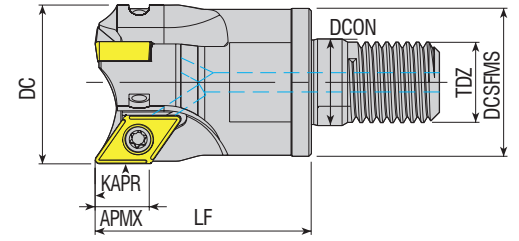

Takım Kodu Ordering Code Bestell-Bezeichnung	Stok Stock Lager	Takım Ölçüleri (mm) Dimension (mm) Abmessung (mm)							Kesici Uç Insert Wendeschneidplatte	Yedek Parçaları / Spare Parts / Ersatzteile	
		DC	ZEFP	DCSFMS	TDZ	LF	DCON	APMX		Sıkma Vidası Screw Schraube	Tork Anahtar Torx Key Torx-Schlüssel
AEM90-DC07-D20-M10-L30-Z02-H	●	20	2	18	M10	30	10.5	7	DC.T 0702..	3008-M2.5x6	82-T08
AEM90-DC07-D25-M12-L35-Z03-H	●	25	3	21	M12	35	12.5	7			
AEM90-DC07-D32-M16-L43-Z04-H	●	32	4	29	M16	43	17	7			
AEM90-DC07-D40-M16-L43-Z05-H	●	40	5	29	M16	43	17	7			
AEM90-DC11-D32-M16-L43-Z03-H-F	●	32	3	29	M16	43	17	11	DC.T 11T3..	4015-M3.5x9	80-T15
AEM90-DC11-D40-M16-L43-Z03-H-F	●	40	3	29	M16	43	17	11			

R: Sağ / Right / Rechts L: Sol / Left / Links

● Stokta / In Stock / Auf Lager ○ Stokta Yok / Non Stock Item / Kein Lagerartikel, Lieferzeit auf Anfrage

ISO Ucuna Uygun. / Compatible with ISO Insert. / Kompatibel mit ISO Wendeplatten.

F: Eksenel ve Radyal Salgı Değeri 0,02 mm içindedir. / F: Axial and Radial Runout Value is within 0,02 mm. / F: Der axiale und radiale Rundlaufwert liegt innerhalb von 0,02 mm.

Sipariş Örneği/Ordering Example/Bestellbeispiel

1 ad./pcs./stück AEM90-BD11T3-D16-M08-L25-Z02-H

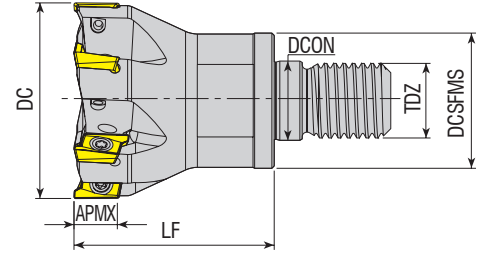

Takım Kodu Ordering Code Bestell-Bezeichnung	Stok Stock Lager	Takım Ölçüleri (mm) Dimension (mm) Abmessung (mm)							Kesici Uç Insert Wendeschneidplatte	Yedek Parçaları / Spare Parts / Ersatzteile	
		DC	ZEFP	DCSFMS	TDZ	LF	DCON	APMX		Sıkma Vidası Screw Schraube	Tork Anahtar Torx Key Torx-Schlüssel
AEM90-RT10-D16-M08-L20-Z02-H	●	16	2	14.75	M08	20	8.5	10			
AEM90-RT10-D20-M10-L25-Z03-H	●	20	3	18	M10	25	10.5	10			
AEM90-RT10-D25-M12-L30-Z04-H	●	25	4	21	M12	30	12.5	10			
AEM90-RT10-D32-M16-L43-Z05-H	●	32	5	29	M16	43	17	10			
AEM90-RT10-D42-M16-L43-Z06-H	●	42	6	29	M16	43	17	10			

SFTY Ucuna Uygundur. / Compatible with SFTY Insert. / Kompatibel mit SFTY Wendeplatten.

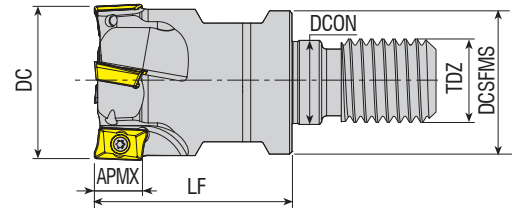

Takım Kodu Ordering Code Bestell-Bezeichnung	Stok Stock Lager	Takım Ölçüleri (mm) Dimension (mm) Abmessung (mm)							Kesici Uç Insert Wendeschneidplatte	Yedek Parçaları / Spare Parts / Ersatzteile	
		DC	ZEFP	DCSFMS	TDZ	LF	DCON	APMX		Sıkma Vidası Screw Schraube	Tork Anahtar Torx Key Torx-Schlüssel
AEM90-R390.11-D16-M08-L30-Z02-H	●	16	2	14.75	M08	30	8.5	10		3008-M2.5x5	
AEM90-R390.11-D20-M10-L30-Z03-H	●	20	3	18	M10	30	10.5	10			
AEM90-R390.11-D25-M12-L35-Z03-H	●	25	3	21	M12	35	12.5	10			
AEM90-R390.11-D32-M16-L43-Z04-H	●	32	4	29	M16	43	17	10			
										R390-11T3..	

R: Sağ / Right / Rechts/ L: Sol / Left / Links

● Stokta / In Stock / Auf Lager ○ Stokta Yok / Non Stock Item / Kein Lagerartikel, Lieferzeit auf Anfrage  
SNDVK Ucuna Uygundur. / Compatible with SNDVK Insert. / Kompatibel mit SNDVK Wendeplatten.

Sipariş Örneği/Ordering Example/Bestellbeispiel  
1 ad./pcs./stück AEM90-RT10-D16-M08-L20-Z02-H

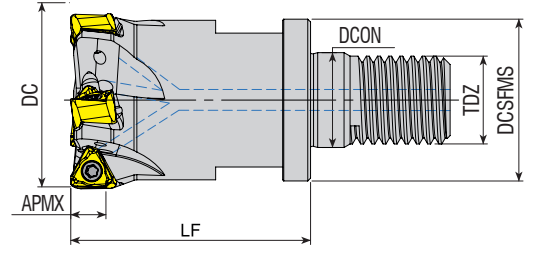

Takım Kodu Ordering Code Bestell-Bezeichnung	Stok Stock Lager	Takım Ölçüleri (mm) Dimension (mm) Abmessung (mm)							Kesici Uç Insert Wendeschneidplatte	Yedek Parçaları / Spare Parts / Ersatzteile	
		DC	ZEFP	DCSFMS	TDZ	LF	DCON	APMX		Sıkma Vidası Screw Schraube	Tork Anahtar Torx Key Torx-Schlüssel
• new • AEM90-TNG10-D20-M10-L26-Z02-H	●	20	2	18	M10	26	10.5	5	TNGX 1004..	3008-M2.5x6	82-T08
• new • AEM90-TNG10-D20-M10-L26-Z03-H	●	20	3	18	M10	26	10.5	5			
AEM90-TNG10-D21-M10-L25-Z03-H	●	21	3	18	M10	25	10.5	5			
• new • AEM90-TNG10-D25-M12-L33-Z03-H	●	25	3	21	M12	33	12.5	5			
• new • AEM90-TNG10-D25-M12-L33-Z04-H	●	25	4	21	M12	33	12.5	5			
AEM90-TNG10-D26-M12-L30-Z04-H	●	26	4	21	M12	30	12.5	5			
• new • AEM90-TNG10-D32-M16-L43-Z04-H	●	32	4	29	M16	43	17	5			
• new • AEM90-TNG10-D32-M16-L43-Z05-H	●	32	5	29	M16	43	17	5			
AEM90-TNG10-D33-M16-L43-Z05-H	●	33	5	29	M16	43	17	5			
AEM90-TNG10-D35-M16-L43-Z05-H	●	35	5	29	M16	43	17	5			

PRMT Ucuna Uygun. / Compatible with PRMT Insert. / Kompatibel mit PRMT Wendeplatten.

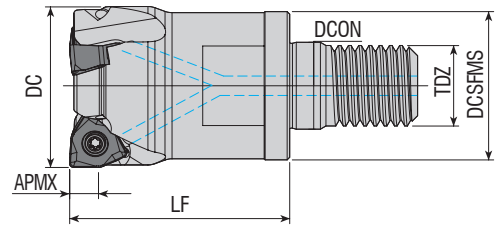

Takım Kodu Ordering Code Bestell-Bezeichnung	Stok Stock Lager	Takım Ölçüleri (mm) Dimension (mm) Abmessung (mm)							Kesici Uç Insert Wendeschneidplatte	Yedek Parçaları / Spare Parts / Ersatzteile	
		DC	ZEFP	DCSFMS	TDZ	LF	DCON	APMX		Sıkma Vidası Screw Schraube	Tork Anahtar Torx Key Torx-Schlüssel
AEM90-WN0604Z-D25-M12-L35-Z02-H	●	25	2	21	M12	35	12.5	5.7	WNHU 0604..	3008-M3x8	82-T08
AEM90-WN0604Z-D32-M16-L43-Z03-H	●	32	3	29	M16	43	17	5.7			
AEM90-WN0604Z-D40-M16-L43-Z04-H	●	40	4	29	M16	43	17	5.7			

R: Sağ / Right / Rechts/ L: Sol / Left / Links

● Stokta / In Stock / Auf Lager ○ Stokta Yok / Non Stock Item / Kein Lagerartikel, Lieferzeit auf Anfrage  
ZCC Ucuna Uygun. / Compatible with ZCC Insert. / Kompatibel mit ZCC Wendeplatten.

Sipariş Örneği/Ordering Example/Bestellbeispiel

1 ad./pcs./stück AEM90-TNG10-D20-M10-L26-Z02-H

Kesme Hesabı : S 377/ Cutting Calculation : P 377 / Schnittberechnung : P 377

Sıkma Tork Değeri : S 376 / Tightening Torque : P 376 / Anzugsmoment : P 376

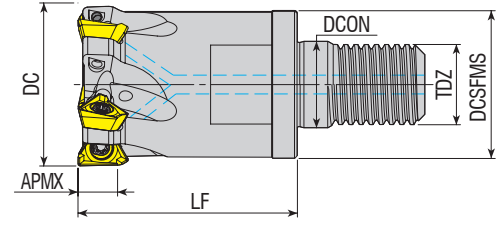

Takım Kodu Ordering Code Bestell-Bezeichnung	Stok Stock Lager	Takım Ölçüleri (mm) Dimension (mm) Abmessung (mm)							Kesici Uç Insert Wendeschneidplatte	Yedek Parçaları / Spare Parts / Ersatzteile	
		DC	ZEFP	DCSFMS	TDZ	LF	DCON	APMX		Sıkma Vidası Screw Schraube	Tork Anahtar Torx Key Torx-Schlüssel
AEM90-3P1004-D20-M10-L35-Z02	●	20	2	18	10	35	10.5	7	3PT 1004	1108-M2.5x6	82-T08
AEM90-3P1004-D32-M16-L43-Z05-H	●	32	5	29	16	43	17	7			

TGTC Ucuna Uygunur. / Compatible with TGTC Insert. / Kompatibel mit TGTC Wendepplatten.

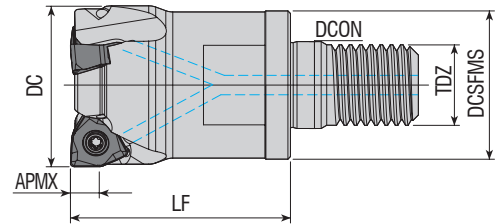

Takım Kodu Ordering Code Bestell-Bezeichnung	Stok Stock Lager	Takım Ölçüleri (mm) Dimension (mm) Abmessung (mm)							Kesici Uç Insert Wendeschneidplatte	Yedek Parçaları / Spare Parts / Ersatzteile	
		DC	ZEFP	DCSFMS	TDZ	LF	DCON	APMX		Sıkma Vidası Screw Schraube	Tork Anahtar Torx Key Torx-Schlüssel
AEM90-XN0403-D32-M16-L43-Z05-H	●	32	5	29	M16	43	17	4	XNEX 0403..	3008-M2.5x6	82-T08
AEM90-XN0403-D42-M16-L43-Z06-H	●	42	6	29	M16	43	17	4			

R: Sağ / Right / Rechtsl L: Sol / Left / Links

● Stokta / In Stock / Auf Lager ○ Stokta Yok / Non Stock Item / Kein Lagerartikel, Lieferzeit auf Anfrage

SC Ucuna Uygunur. / Compatible with SC Insert. / Kompatibel mit SC Wendepplatten.

Sipariş Örneği/Ordering Example/Образец заказа  
1 ad./pcs./шт. AEM90-3P1004-D20-M10-L35-Z02  
Kesme Hesabı : S 377 / Cutting Calculation : P 377 / Schnittberechnung : P 377

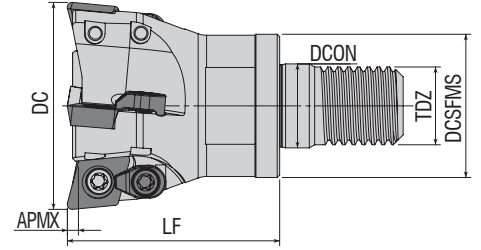

Takım Kodu Ordering Code Bestell-Bezeichnung	Stok Stock Lager	Takım Ölçüleri (mm) Dimension (mm) Abmessung (mm)						Kesici Uç Insert Wendeschneidplatte	Yedek Parçaları / Spare Parts / Ersatzteile				
		DC	ZEFP	DCSFMS	TDZ	LF	DCON		APMX	Sıkma Vidası Screw Schraube	Baskı Parçası Wedge Clamp Spannpratze	Baskı Vidası Clamp Screw Schraube	Tork Anahtar Torx Key Torx-Schlüssel
AEM95-XD0206-D16-M08-L23-Z02-H	●	16	2	14.75	M08	23	8.5	1	XDHW 0206..	3008-M2.5x5	-	-	82-T08
AEM95-XD0206-D16-M08-L23-Z02-H-F	●	16	2	14.75	M08	23	8.5	1					
AEM95-XD0206-D20-M10-L30-Z03-H	●	20	3	18	M10	30	10.5	1					
AEM95-XD0206-D20-M10-L30-Z03-H-F	●	20	3	18	M10	30	10.5	1					
AEM95-XD0206-D25-M12-L35-Z03-H	●	25	3	21	M12	35	12.5	1					
AEM95-XD0206-D25-M12-L35-Z03-H-F	●	25	3	21	M12	35	12.5	1					
AEM95C-XD0310-D35-M16-L43-Z03-H	●	35	3	29	M16	43	17	1.5	XDHW 0310..	3015-M3.5x9	ACK-15	4015-M3.5x11	80-T15
AEM95C-XD0310-D35-M16-L43-Z03-H-F	●	35	3	29	M16	43	17	1.5					
AEM95C-XD0310-D42-M16-L43-Z04-H	●	42	4	29	M16	43	17	1.5					
AEM95C-XD0310-D42-M16-L43-Z04-H-F	●	42	4	29	M16	43	17	1.5					

DJT Ucuna Uygun. / Compatible with DJT Insert. / Kompatibel mit DJT Wendeplatten.

Çap Ölçüsü - 0,02 mm Olarak üretiliyor. F: ± 0,02 mm Demektir. Ör: Ø16 Takım 15,98 ± 0,02 mm yani 16,00 mm - 15,96 mm Olmalıdır.

Diameter Size is produced as - 0.02 mm. F: means ± 0,02 mm. For example: Ø16 tool 15,98 ± 0,02 mm, it means that it should be 16,00 mm - 15,96 mm.

Durchmesser - Es wird mit -0,02 mm hergestellt. Das heißt F: ± 0,02 mm. Zum Beispiel: Der Ø16-Satz sollte 15,98 ± 0,02 mm, 16,00 mm - 15,96 mm betragen.

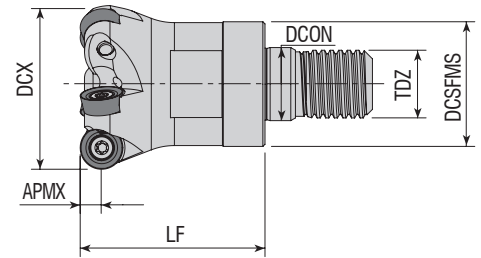

Takım Kodu Ordering Code Bestell-Bezeichnung	Stok Stock Lager	Takım Ölçüleri (mm) Dimension (mm) Abmessung (mm)						Kesici Uç Insert Wendeschneidplatte	Yedek Parçaları / Spare Parts / Ersatzteile		
		DCX	ZEFP	DCSFMS	TDZ	LF	DCON		APMX	Sıkma Vidası Screw Schraube	Tork Anahtar Torx Key Torx-Schlüssel
AEMR-RC10T3-D25-M12-L35-Z03-H	●	25	3	21	M12	35	12.5	5	RC.. 10T3..	4015-M4x9	80-T15
AEMR-RC10T3-D32-M16-L43-Z04-H	●	32	4	29	M16	43	17	5			
AEMR-RC10T3-D40-M16-L43-Z05-H	●	40	5	29	M16	43	17	5			

ZCC Ucuna Uygun. / Compatible with ZCC Insert. / Kompatibel mit ZCC Wendeplatten.

Sipariş Örneği/Ordering Example/Bestellbeispiel

1 ad./pcs./stück AEM95-XD0206-D16-M08-L23-Z02-H

Kesme Hesabı : S 367 / Cutting Calculation : P 367 / Schnittberechnung : P 367

Sıkma Tork Değeri : S 376 / Tightening Torque : P 376 / Anzugsmoment : P 376



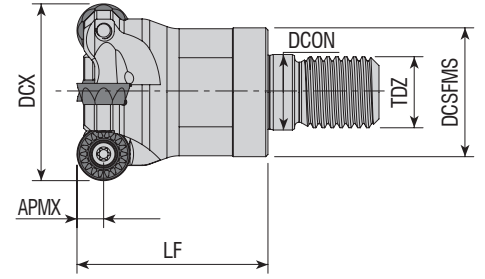

Takım Kodu Ordering Code Bestell-Bezeichnung	Stok Stock Lager	Takım Ölçüleri (mm) Dimension (mm) Abmessung (mm)							Kesici Uç Insert Wendeschneidplatte	Yedek Parçaları / Spare Parts / Ersatzteile	
		DCX	ZEFP	DCSFMS	TDZ	LF	DCON	APMX		Sıkma Vidası Screw Schraube	Tork Anahtar Torx Key Torx-Schlüssel
AEMR-RP08T2M-D20-M10-L30-Z02-H	●	20	2	18	M10	30	10.5	4		3008-M2.5x6	82-T08
AEMR-RP10T3M-D25-M12-L35-Z02-H	●	25	2	21	M12	35	12.5	5	RPMT 10T3..	4015-M3.5x9	80-T15
AEMR-RP10T3M-D32-M16-L43-Z03-H	●	32	3	29	M16	43	17	5			
AEMR-RP1204M-D32-M16-L43-Z03-H	●	32	3	29	M16	43	17	6	RPMT 1204..	4015-M4x9	
AEMR-RP1204M-D40-M16-L43-Z04-H	●	40	4	29	M16	43	17	6			

MTSBH Ucuna Uygunur. / Compatible with MTSBH Insert. / Kompatibel mit MTSBH Wendeplatten.

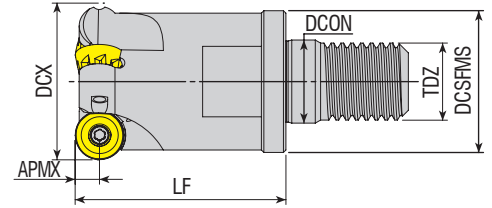

Takım Kodu Ordering Code Bestell-Bezeichnung	Stok Stock Lager	Takım Ölçüleri (mm) Dimension (mm) Abmessung (mm)							Kesici Uç Insert Wendeschneidplatte	Yedek Parçaları / Spare Parts / Ersatzteile	
		DCX	ZEFP	DCSFMS	TDZ	LF	DCON	APMX		Sıkma Vidası Screw Schraube	Tork Anahtar Torx Key Torx-Schlüssel
AEMR-RP10T3-D25-M12-L35-Z02-H	●	25	2	21	M12	35	12.5	5	RPNX 10T3..	4010-M3x8	82-T10
AEMR-RP10T3-D32-M16-L43-Z03-H	●	32	3	29	M16	43	17	5			RPNX 1204..
AEMR-RP1204-D32-M16-L43-Z03-H	●	32	3	29	M16	43	17	6			

R: Sağ / Right / Rechts/ L: Sol / Left / Links

● Stokta / In Stock / Auf Lager ○ Stokta Yok / Non Stock Item / Kein Lagerartikel, Lieferzeit auf Anfrage  
CRTZT Ucuna Uygunur. / Compatible with CRTZT Insert. / Kompatibel mit CRTZT Wendeplatten.

Sipariş Örneği/Ordering Example/Bestellbeispiel

1 ad./pcs./stück AEMR-RP08T2M-D20-M10-L30-Z02-H

Kesme Hesabı : S 367 / Cutting Calculation : P 367 / Schnittberechnung : P 367

Sıkma Tork Değeri : S 367 / Tightening Torque : P 367 / Anzugsmoment : P 367

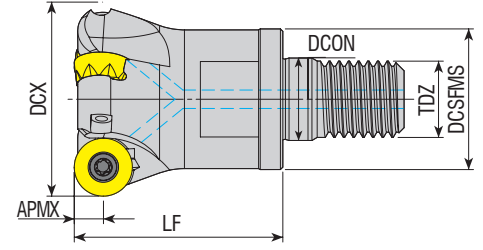

Takım Kodu Ordering Code Bestell-Bezeichnung	Stok Stock Lager	Takım Ölçüleri (mm) Dimension (mm) Abmessung (mm)							Kesici Uç Insert Wendeschneidplatte	Yedek Parçaları / Spare Parts / Ersatzteile		
		DCX	ZEFP	DCSFMS	TDZ	LF	DCON	APMX		Sıkma Vidası Screw Schraube	Baskı Parçası Wedge Clamp Spannpratze	Baskı Vidası Clamp Screw Schraube
<b>new</b> AEMR-RY10-D25-M12-L43-Z03-H	●	25	3	21	M12	43	12.5	5	RYMX 1004..	4015-M3.5x9	80-T15	
AEMR-RY10-D32-M16-L43-Z04-H	●	32	4	29	M16	43	17	5				
AEMR-RY10-D40-M16-L43-Z05-H	●	40	5	29	M16	43	17	5				
AEMR-RY12-D32-M16-L43-Z03-H	●	32	3	29	M16	43	17	6	RYMX 1205..	4015-M4x9	80-T15	
AEMR-RY12-D40-M16-L43-Z03-H	●	40	3	29	M16	43	17	6				

TGTC Ucuna Uygun. / Compatible with TGTC Insert. / Kompatibel mit TGTC Wendeplatten.

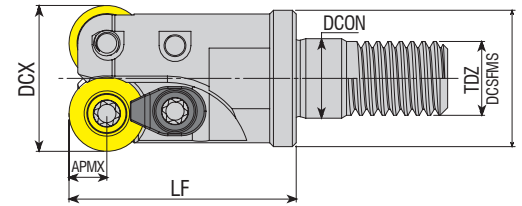
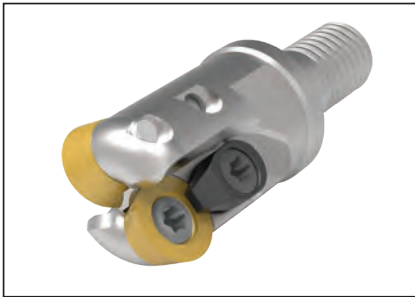

Takım Kodu Ordering Code Bestell-Bezeichnung	Stok Stock Lager	Takım Ölçüleri (mm) Dimension (mm) Abmessung (mm)							Kesici Uç Insert Wendeschneidplatte	Yedek Parçaları / Spare Parts / Ersatzteile			
		DCX	ZEFP	DCSFMS	TDZ	LF	DCON	APMX		Sıkma Vidası Screw Schraube	Baskı Parçası Wedge Clamp Spannpratze	Baskı Vidası Clamp Screw Schraube	Tork Anahtar Torx Key Torx-Schlüssel
AEMRC-RD10T3-D20-M10-L30-Z02	●	20	2	18	M10	30	10.5	5	RD.. 10T3	4015-M3.5x9	ACK-15	4015-M3.5x11	80-T15
AEMRC-RD10T3-D32-M16-L43-Z03-H	●	32	3	29	M16	43	17	5					

R: Sağ / Right / Rechts L: Sol / Left / Links

● Stokta / In Stock / Auf Lager ○ Stokta Yok / Non Stock Item / Kein Lagerartikel, Lieferzeit auf Anfrage  
ISO Ucuna Uygun. / Compatible with ISO Insert. / Kompatibel mit ISO Wendeplatten.

Sipariş Örneği/Ordering Example/Bestellbeispiel

1 ad./pcs./stück AEMR-RY10-D25-M12-L43-Z03-H

Kesme Hesabı : S 377/ Cutting Calculation : P 377 / Schnittberechnung : P 377

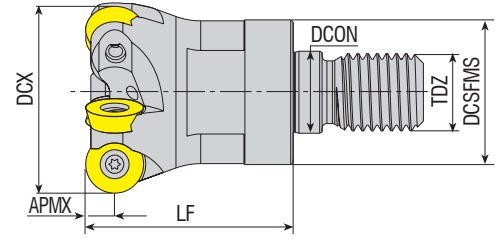

Takım Kodu Ordering Code Bestell-Bezeichnung	Stok Stock Lager	Takım Ölçüleri (mm) Dimension (mm) Abmessung (mm)							Kesici Uç Insert Wendeschneidplatte	Yedek Parçaları / Spare Parts / Ersatzteile		
		DCX	ZEFP	DCSFMS	TDZ	LF	DCON	APMX		Sıkma Vidası Screw Schraube	Tork Anahtar Torx Key Torx-Schlüssel	
AEMR-RD0702-D15-M08-L23-Z02-H	●	15	2	13	M08	23	8.5	3.5	RD.. 0702	3008-M2.5x6	82-T08	
AEMR-RD0702-D16-M08-L23-Z02-H	●	16	2	14.75	M08	23	8.5	3.5				
AEMR-RD0702-D20-M10-L30-Z04-H	●	20	4	18	M10	30	10.5	3.5				
AEMR-RD0702-D25-M12-L35-Z05-H	●	25	5	21	M12	35	12.5	3.5				
AEMR-RD0702-D30-M16-L42-Z05-H	●	30	5	29	M16	42	17	3.5				
AEMR-RD0702-D32-M16-L43-Z05-H	●	32	5	29	M16	43	17	3.5				
AEMR-RD0702-D35-M16-L42-Z06-H	●	35	6	29	M16	42	17	3.5				
AEMR-RD0702-D42-M16-L43-Z05-H	●	42	5	29	M16	43	17	3.5				
AEMR-RD0702-D42-M16-L43-Z07-H	●	42	7	29	M16	43	17	3.5				
AEMR-RD08T2-D16-M08-L23-Z02-H	●	16	2	13	M08	23	8.5	4	RD.. 08T2	3008-M2.5x6	82-T08	
AEMR-RD08T2-D16-M10-L23-Z02-H	●	16	2	13	M10	23	8.5	4				
AEMR-RD08T2-D20-M10-L30-Z03-H	●	20	3	18	M10	30	10.5	4				
AEMR-RD08T2-D25-M12-L35-Z04-H	●	25	4	21	M12	35	12.5	4	RD.. 0802	3008-M3x6	80-T15	
AEMR-RD0802-D16-M08-L23-Z02-H	●	16	2	13	M08	23	8.5	4	RD.. 0803	3008-M3x8		
AEMR-RD0803-D16-M08-L23-Z02-H	●	16	2	13	M08	23	8.5	4				
AEMR-RD0803-D20-M10-L30-Z03-H	●	20	3	18	M10	30	10.5	4	RD.. 1003	4015-M3.5x9	80-T15	
AEMR-RD0803-D25-M12-L35-Z04-H	●	25	4	21	M12	35	12.5	4				
AEMR-RD1003-D20-M10-L30-Z02-H	●	20	2	18	M10	30	10.5	5				
AEMR-RD1003-D25-M12-L35-Z02-H	●	25	2	21	M12	35	12.5	5				
AEMR-RD1003-D25-M12-L35-Z03-H	●	25	3	21	M12	35	12.5	5				
AEMR-RD1003-D30-M16-L43-Z04-H	●	30	4	29	M16	43	17	5				
AEMR-RD1003-D32-M16-L43-Z04-H	●	32	4	29	M16	43	17	5				
AEMR-RD1003-D35-M16-L43-Z04-H	●	35	4	29	M16	43	17	5				
AEMR-RD1003-D40-M16-L43-Z05-H	●	40	5	29	M16	43	17	5				
AEMR-RD1003-D42-M16-L43-Z05-H	●	42	5	29	M16	43	17	5				
AEMR-RD10T3-D25-M12-L35-Z03-H	●	25	3	21	M12	35	12.5	5	RD.. 10T3	4015-M3.5x9	80-T15	
AEMR-RD10T3-D32-M16-L45-Z04-H	●	32	4	29	M16	45	17	5				
AEMR-RD10T3-D35-M16-L43-Z04-H	●	35	4	29	M16	43	17	5				
AEMR-RD10T3-D42-M16-L43-Z05-H	●	42	5	29	M16	43	17	5	RD.. 1004	4515-M4x8	80-T15	
AEMR-RD1004-D25-M12-L35-Z03-H	●	25	3	21	M12	35	12.5	5				
AEMR-RD1004-D32-M16-L43-Z04-H	●	32	4	29	M16	43	17	5				
AEMR-RD1004-D42-M16-L43-Z05-H	●	42	5	29	M16	43	17	5				
AEMR-RD12T3-D24-M12-L35-Z02-H	●	24	2	21	M12	35	12.5	6	RD.. 12T3	4015-M3.5x9	80-T15	
AEMR-RD12T3-D25-M12-L35-Z02-H	●	25	2	21	M12	35	12.5	6				
AEMR-RD12T3-D32-M16-L43-Z03-H	●	32	3	29	M16	43	17	6				
AEMR-RD12T3-D35-M16-L43-Z03-H	●	35	3	29	M16	43	17	6				
AEMR-RD12T3-D35-M16-L43-Z04-H	●	35	4	29	M16	43	17	6				
AEMR-RD12T3-D40-M16-L43-Z04-H	●	40	4	29	M16	43	17	6				
AEMR-RD12T3-D42-M16-L43-Z05-H	●	42	5	29	M16	43	17	6				
AEMR-RD1204-D25-M12-L35-Z02-H	●	25	2	21	M12	35	12.5	6				RD.. 1204
AEMR-RD1204-D32-M16-L43-Z03-H	●	32	3	29	M16	43	17	6				
AEMR-RD1204-D40-M16-L43-Z04-H	●	40	4	29	M16	43	17	6				
AEMR-RD1204-D42-M16-L43-Z04-H	●	42	4	29	M16	43	17	6	RD.. 1604	4015-M4.5x11	80-T15	
AEMR-RD1604-D32-M16-L43-Z02-H	●	32	2	29	M16	43	17	8				
AEMR-RD1604-D40-M16-L43-Z02-H	●	40	2	29	M16	43	17	8				
AEMR-RD1604-D42-M16-L43-Z03-H	●	42	3	29	M16	43	17	8				

R: Sağ / Right / Rechts/ L: Sol / Left / Links

● Stokta / In Stock / Auf Lager ○ Stokta Yok / Non Stock Item / Kein Lagerartikel, Lieferzeit auf Anfrage  
ISO Uçuna Uygundur. / Compatible with ISO Insert. / Kompatibel mit ISO Wendepplatten.

Sipariş Örneği/Ordering Example/Bestellbeispiel

1 ad./pcs./stück AEMR-RD0702-D15-M08-L23-Z02-H

Kesme Hesabı : S 377/ Cutting Calculation : P 377 / Schnittberechnung : P 377

Sıkma Tork Değeri : S 376 / Tightening Torque : P 376 / Anzugsmoment : P 376

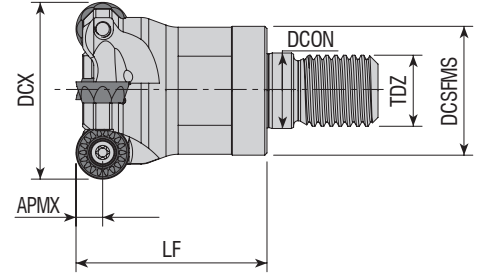

Takım Kodu Ordering Code Bestell-Bezeichnung	Stok Stock Lager	Takım Ölçüleri (mm) Dimension (mm) Abmessung (mm)							Kesici Uç Insert Wendeschneidplatte	Yedek Parçaları / Spare Parts / Ersatzteile	
		DCX	ZEFP	DCSFMS	TDZ	LF	DCON	APMX		Sıkma Vidası Screw Schraube	Tork Anahtar Torx Key Torx-Schlüssel
AEMR-RP10T3A-D32-M16-L43-Z04-H	●	32	4	29	M16	43	17	5			
AEMR-RP10T3A-D42-M16-L43-Z05-H	●	42	5	29	M16	43	17	5			

ACHTK Ucuna Uygunur. / Compatible with ACHTK Insert. / Kompatibel mit ACHTK Wendeplatten.

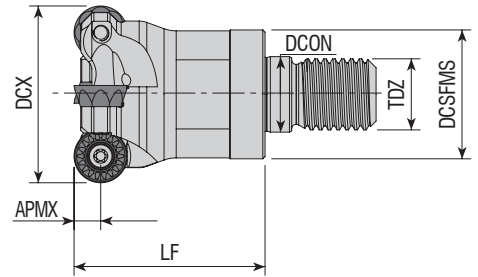

Takım Kodu Ordering Code Bestell-Bezeichnung	Stok Stock Lager	Takım Ölçüleri (mm) Dimension (mm) Abmessung (mm)							Kesici Uç Insert Wendeschneidplatte	Yedek Parçaları / Spare Parts / Ersatzteile	
		DCX	ZEFP	DCSFMS	TDZ	LF	DCON	APMX		Sıkma Vidası Screw Schraube	Tork Anahtar Torx Key Torx-Schlüssel
AEMR-RP10T3K-D32-M16-L43-Z04-H	●	32	4	29	M16	43	17	5			
AEMR-RP10T3K-D42-M16-L43-Z05-H	●	43	5	29	M16	43	17	5			

R: Sağ / Right / Rechts/ L: Sol / Left / Links

● Stokta / In Stock / Auf Lager ○ Stokta Yok / Non Stock Item / Kein Lagerartikel, Lieferzeit auf Anfrage



KYCR Ucuna Uygunur. / Compatible with KYCR Insert. / Kompatibel mit KYCR Wendeplatten.

Sipariş Örneği/Ordering Example/Bestellbeispiel

1 ad./pcs./stück AEMR-RP10T3A-D32-M16-L43-Z04-H

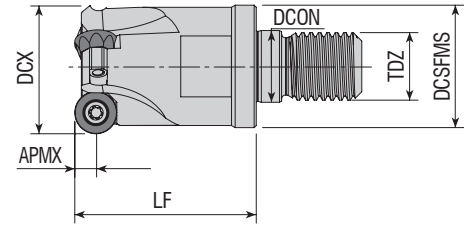

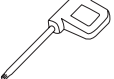

Kesme Hesabı : S 377/ Cutting Calculation : P 377 / Schnittberechnung : P 377

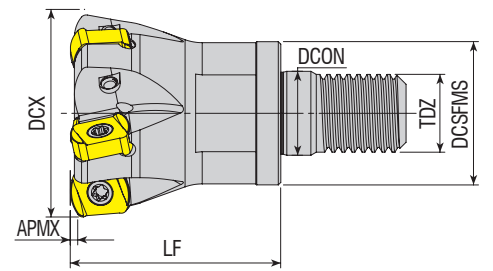

Takım Kodu Ordering Code Bestell-Bezeichnung	Stok Stock Lager	Takım Ölçüleri (mm) Dimension (mm) Abmessung (mm)							Kesici Uç Insert Wendeschneidplatte	Yedek Parçaları / Spare Parts / Ersatzteile		
		DCX	ZEFP	DCSFMS	TDZ	LF	DCON	APMX		Sıkma Vidası Screw Schraube	Tork Anahtar Torx Key Torx-Schlüssel	
AEMR-QP10T3-D25-M12-L35-Z02-H	●	25	2	21	M12	35	12.5	5				
AEMR-QP10T3-D32-M16-L43-Z03-H	●	32	3	29	M16	43	17	5				<b>QP. 10T3..</b>

SMTM Ucuna Uygun. / Compatible with SMTM Insert. / Kompatibel mit SMTM Wendeplatten.

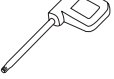

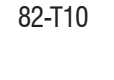
Takım Kodu Ordering Code Bestell-Bezeichnung	Stok Stock Lager	Takım Ölçüleri (mm) Dimension (mm) Abmessung (mm)							Kesici Uç Insert Wendeschneidplatte	Yedek Parçaları / Spare Parts / Ersatzteile		
		DCX	ZEFP	DCSFMS	TDZ	LF	DCON	APMX		Sıkma Vidası Screw Schraube	Tork Anahtar Torx Key Torx-Schlüssel	
AHFM-BL0603-D20-M10-L30-Z03-H	●	20	3	18	M10	30	10.5	1				
<b>new</b> AHFM-BL0603-D25-M12-L35-Z04-H	●	25	4	21	M12	35	12.5	1				<b>BLMP 0603..</b>
AHFM-BL0603-D32-M16-L40-Z05-H	●	32	5	29	M16	40	17	1	<b>BLMP 0904..</b>			
AHFM-BL0904-D32-M16-L40-Z04-H	●	32	4	29	M16	40	17	1.5				
AHFM-BL0904-D32-M16-L43-Z04-H	●	32	4	29	M16	43	17	1.5				
AHFM-BL0904-D42-M16-L43-Z05-H	●	42	5	29	M16	43	17	1.5		3010-M3.5x9	82-T10	

R: Sağ / Right / Rechts L: Sol / Left / Links

● Stokta / In Stock / Auf Lager ○ Stokta Yok / Non Stock Item / Kein Lagerartikel, Lieferzeit auf Anfrage

TGTC Ucuna Uygun. / Compatible with TGTC Insert. / Kompatibel mit TGTC Wendeplatten.

Sipariş Örneği/Ordering Example/Bestellbeispiel

1 ad./pcs./stück AEMR-QP10T3-D25-M12-L35-Z02-H

Kesme Hesabı : S 377 / Cutting Calculation : P 377 / Schnittberechnung : P 377

Sıkma Tork Değeri : S 376 / Tightening Torque : P 376 / Anzugsmoment : P 376

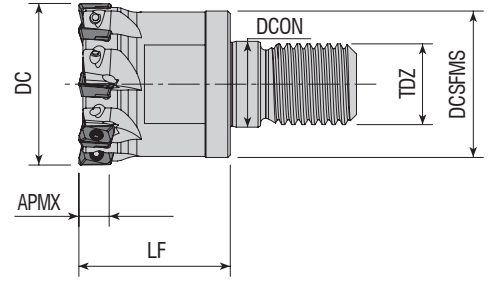

Takım Kodu Ordering Code Bestell-Bezeichnung	Stok Stock Lager	Takım Ölçüleri (mm) Dimension (mm) Abmessung (mm)							Kesici Uç Insert Wendeschneidplatte	Yedek Parçaları / Spare Parts / Ersatzteile	
		DC	ZEFP	DCSFMS	TDZ	LF	DCON	APMX		Sıkma Vidası Screw Schraube	Tork Anahtar Torx Key Torx-Schlüssel
AHFM-ED0702-D12-M06-L20-Z03	●	12	3	10	M06	20	6.5	6	EDMT 0702 JDMT 070204	3006-M1.8x4	82-T06
AHFM-ED0702-D16-M08-L25-Z04-H	●	16	4	14.75	M08	25	8.5	6			
AHFM-ED0702-D20-M10-L30-Z05-H	●	20	5	18	M10	30	10.5	6			
AHFM-ED0702-D25-M12-L30-Z06-H	●	25	6	21	M12	30	12.5	6			
AHFM-ED0702-D32-M16-L30-Z08-H	●	32	8	29	M16	30	17	6			

HTCH Ucuna Uygundur. / Compatible with HTCH Insert. / Kompatibel mit HTCH Wendeplatten.

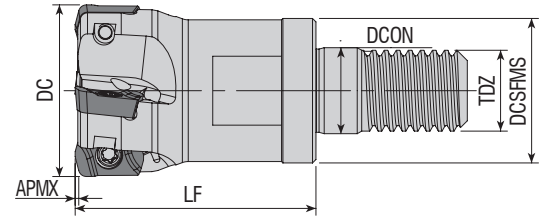

Takım Kodu Ordering Code Bestell-Bezeichnung	Stok Stock Lager	Takım Ölçüleri (mm) Dimension (mm) Abmessung (mm)							Kesici Uç Insert Wendeschneidplatte	Yedek Parçaları / Spare Parts / Ersatzteile	
		DC	ZEFP	DCSFMS	TDZ	LF	DCON	APMX		Sıkma Vidası Screw Schraube	Tork Anahtar Torx Key Torx-Schlüssel
new AHFM-EP1003-D16-M08-L23-Z02	●	16	2	14.75	M08	23	8.5	1	EP. 1003.. ZPMT 1003.. YPHW 1003..	3008-M2.5x5	82-T08
AHFM-EP1003-D16-M08-L23-Z02-H	●	16	2	14.75	M08	23	8.5	1			
new AHFM-EP1003-D20-M10-L30-Z03	●	20	3	18	M10	30	10.5	1		3008-M2.5x6	
AHFM-EP1003-D20-M10-L30-Z04-H	●	20	4	18	M10	30	10.5	1			
AHFM-EP1003-D25-M12-L35-Z04-H	●	25	4	21	M12	35	12.5	1			
AHFM-EP1003-D32-M16-L43-Z05-H	●	32	5	29	M16	43	17	1			
AHFM-EP1003-D35-M16-L43-Z05-H	●	35	5	29	M16	43	17	1			
AHFM-EP1003-D42-M16-L43-Z06-H	●	42	6	29	M16	43	17	1			

R: Sağ / Right / Rechts L: Sol / Left / Links

● Stokta / In Stock / Auf Lager ○ Stokta Yok / Non Stock Item / Kein Lagerartikel, Lieferzeit auf Anfrage

DJT Ucuna Uygundur. / Compatible with DJT Insert. / Kompatibel mit DJT Wendeplatten.

Sipariş Örneği/Ordering Example/ Bestellbeispiel

1 ad./pcs./stück AHFM-ED0702-D12-M06-L20-Z03

Kesme Hesabı : S 377 / Cutting Calculation : P 377 / Schnittberechnung : P 377

Sıkma Tork Değeri : S 376 / Tightening Torque : P 376 / Anzugsmoment : P 376

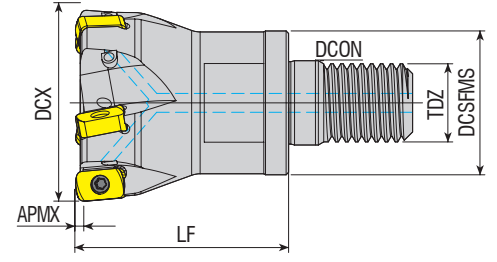

Takım Kodu Ordering Code Bestell-Bezeichnung	Stok Stock Lager	Takım Ölçüleri (mm) Dimension (mm) Abmessung (mm)						Kesici Uç Insert Wendeschneidplatte	Yedek Parçaları / Spare Parts / Ersatzteile				
		DCX	ZEFP	DCSFMS	TDZ	LF	DCON		APMX	Sıkma Vidası Screw Schraube	Baskı Parçası Wedge Clamp Spannpratze	Baskı Vidası Clamp Screw Schraube	Tork Anahtar Torx Key Torx-Schlüssel
AHFM-EN1004-D16-M08-L23-Z02-H	●	16	2	14.75	M08	23	8.5	1	ENMU 1004..	3008-M2.5x5			82-T08
AHFM-EN1004-D20-M10-L30-Z03-H	●	20	3	18	M10	30	10.5	1					
AHFM-EN1004-D25-M12-L35-Z03-H	●	25	3	21	M12	35	12.5	1					
AHFM-EN1004-D25-M12-L35-Z04-H	●	25	4	21	M12	35	12.5	1					
AHFM-EN1004-D32-M16-L43-Z05-H	●	32	5	29	M16	43	17	1					
AHFM-EN1004-D35-M16-L43-Z05-H	●	35	5	29	M16	43	17	1					
AHFM-EN1004-D40-M16-L43-Z05-H	●	40	5	29	M16	43	17	1					
AHFM-EN1004-D42-M16-L43-Z05-H	●	42	5	29	M16	43	17	1					

DJT Ucuna Uygun. / Compatible with DJT Insert. / Kompatibel mit DJT Wendeplatten.

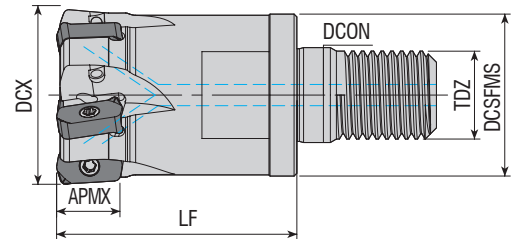

Takım Kodu Ordering Code Bestell-Bezeichnung	Stok Stock Lager	Takım Ölçüleri (mm) Dimension (mm) Abmessung (mm)						Kesici Uç Insert Wendeschneidplatte	Yedek Parçaları / Spare Parts / Ersatzteile				
		DCX	ZEFP	DCSFMS	TDZ	LF	DCON		APMX	Sıkma Vidası Screw Schraube	Baskı Parçası Wedge Clamp Spannpratze	Baskı Vidası Clamp Screw Schraube	Tork Anahtar Torx Key Torx-Schlüssel
AHFM-LN0303-D25-M12-L35-Z04-H	●	25	4	21	M12	35	12.5	12	LNMU 0303..	3008-M2.5x6			82-T08
AHFM-LN0303-D32-M16-L43-Z05-H	●	32	5	29	M16	43	17	12					
AHFM-LN0303-D42-M16-L43-Z06-H	●	42	6	29	M16	43	17	12					

R: Sağ / Right / Rechts L: Sol / Left / Links

● Stokta / In Stock / Auf Lager ○ Stokta Yok / Non Stock Item / Kein Lagerartikel, Lieferzeit auf Anfrage

TNGLY Ucuna Uygun. / Compatible with TNGLY Insert. / Kompatibel mit TNGLY Wendeplatten.

Sipariş Örneği/Ordering Example/Bestellbeispiel

1 ad./pcs./stück AHFM-EN1004-D16-M08-L23-Z02-H

Kesme Hesabı : S 377 / Cutting Calculation : P 377 / Schnittberechnung : P 377

Sıkma Tork Değeri : S 376 / Tightening Torque : P 376 / Anzugmoment : P 376

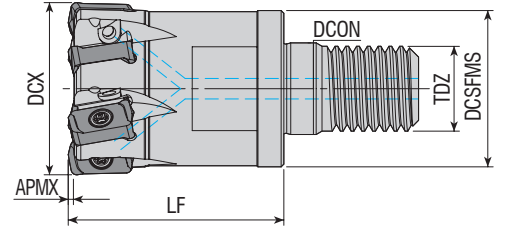

Takım Kodu Ordering Code Bestell-Bezeichnung	Stok Stock Lager	Takım Ölçüleri (mm) Dimension (mm) Abmessung (mm)						Kesici Uç Insert Wendeschneidplatte	Yedek Parçaları / Spare Parts / Ersatzteile				
		DCX	ZEPF	DCSFMS	TDZ	LF	DCON		APMX	Sıkma Vidası Screw Schraube	Baskı Parçası Wedge Clamp Spannpratze	Baskı Vidası Clamp Screw Schraube	Tork Anahtar Torx Key Torx-Schlüssel
AHFM-L003-D20-M10-L30-Z04-H-F	●	20	4	18	M10	30	10.5	1	LOGU 0303..	1108-M3x6.8	-	-	82-T08
AHFM-L003-D25-M12-L35-Z04-H-F	●	25	4	21	M12	35	12.5	1					
AHFM-L003-D25-M12-L35-Z04-H	●	25	4	21	M12	35	12.5	1					
AHFM-L003-D32-M16-L40-Z05-H-F	●	32	5	29	M16	40	17	1					
AHFM-L003-D32-M16-L40-Z05-H	●	32	5	29	M16	40	17	1					
AHFM-L003-D32-M16-L40-Z06-H-F	●	32	6	29	M16	40	17	1					
AHFM-L003-D32-M16-L40-Z06-H	●	32	6	29	M16	40	17	1					
AHFM-L003-D35-M16-L40-Z05-H	●	35	5	29	M16	40	17	1					
AHFM-L003-D35-M16-L40-Z06-H	●	35	6	29	M16	40	17	1					
AHFM-L003-D42-M16-L40-Z05-H	●	42	5	29	M16	40	17	1					
AHFM-L003-D42-M16-L40-Z06-H	●	42	6	29	M16	40	17	1					

R: Sağ / Right / Rechts / L: Sol / Left / Links

● Stokta / In Stock / Auf Lager ○ Stokta Yok / Non Stock Item / Kein Lagerartikel, Lieferzeit auf Anfrage  
KYCR Ucuna Uygundur. / Compatible with KYCR Insert. / Kompatibel mit KYCR Wendepatten.

F: Eksenel ve Radyal Salgı Değeri 0,02 mm içindedir. / F: Axial and Radial Runout Value is within 0,02 mm.

F: Der axiale und radiale Rundlaufwert liegt innerhalb von 0,02 mm.

Kesme Hesabı : S 367 / Cutting Calculation : P 367 / Schnittberechnung : P 367

Sıkma Tork Değeri : S 367 / Tightening Torque : P 367 / Anzugsmoment : P 367

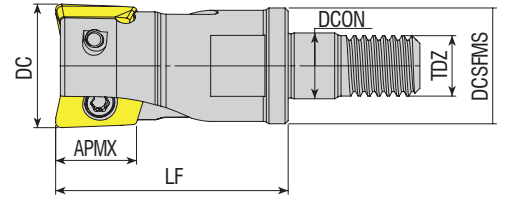

Takım Kodu Ordering Code Bestell-Bezeichnung	Stok Stock Lager	Takım Ölçüleri (mm) Dimension (mm) Abmessung (mm)						Kesici Uç Insert Wendeschneidplatte	Yedek Parçaları / Spare Parts / Ersatzteile		
		DC	ZEPF	DCSFMS	TDZ	LF	DCON		APMX	Sıkma Vidası Screw Schraube	Tork Anahtar Torx Key Torx-Schlüssel
AHFM-JD1003-D16-M08-L30-Z02-H	●	16	2	14.75	M08	30	8.5	9	JDMT 1003..	3008-M2.5x6	82-T08
AHFM-JD1003-D20-M10-L30-Z03-H	●	20	3	18	M10	30	10.5	9			

HTCH Ucuna Uygundur. / Compatible with HTCH Insert. / Kompatibel mit HTCH Wendepatten.

Sipariş Örneği/Ordering Example/Bestellbeispiel

1 ad./pcs./stück AHFM-L003-D20-M10-L30-Z04-H-F



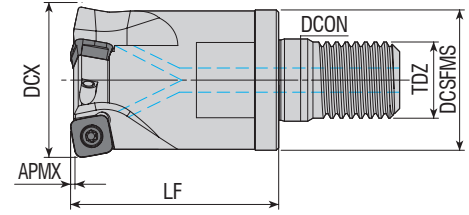

Takım Kodu Ordering Code Bestell-Bezeichnung	Stok Stock Lager	Takım Ölçüleri (mm) Dimension (mm) Abmessung (mm)							Kesici Uç Insert Wendeschneidplatte	Yedek Parçaları / Spare Parts / Ersatzteile		
		DCX	ZEFP	DCSFMS	TDZ	LF	DCON	APMX		Sıkma Vidası Screw Schraube	Tork Anahtar Torx Key Torx-Schlüssel	
AHFM-SD1205-D32-M16-L40-Z03-H	●	32	3	29	M16	40	17	2				
AHFM-SD1205-D35-M16-L40-Z03-H	●	35	3	29	M16	40	17	2				
AHFM-SD1205-D40-M16-L43-Z03-H	●	40	3	29	M16	43	17	2				
AHFM-SD1205-D42-M16-L43-Z03-H	●	42	3	29	M16	43	17	2				

HTCH Ucuna Uygundur. / Compatible with HTCH Insert. / Kompatibel mit HTCH Wendeplatten.

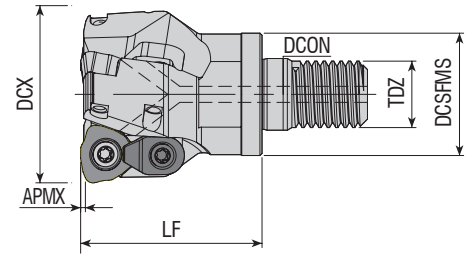

Takım Kodu Ordering Code Bestell-Bezeichnung	Stok Stock Lager	Takım Ölçüleri (mm) Dimension (mm) Abmessung (mm)							Kesici Uç Insert Wendeschneidplatte	Yedek Parçaları / Spare Parts / Ersatzteile			
		DCX	ZEFP	DCSFMS	TDZ	LF	DCON	APMX		Sıkma Vidası Screw Schraube	Baskı Parçası Wedge Clamp Spannpratze	Baskı Vidası Clamp Screw Schraube	Tork Anahtar Torx Key Torx-Schlüssel
AHFMC-JD1204-D32-M16-L43-Z02-H	●	32	2	29	M16	43	17	1.5					
AHFMC-JD1204-D42-M16-L43-Z03-H	●	42	3	29	M16	43	17	1.5					

R: Sağ / Right / Rechts L: Sol / Left / Links

● Stokta / In Stock / Auf Lager ○ Stokta Yok / Non Stock Item / Kein Lagerartikel, Lieferzeit auf Anfrage

MTSBH Ucuna Uygundur. / Compatible with MTSBH Insert. / Kompatibel mit MTSBH Wendeplatten.

Sipariş Örneği/Ordering Example/Bestellbeispiel  
1 ad./pcs./stück AHFM-SD1205-D32-M16-L40-Z03-H

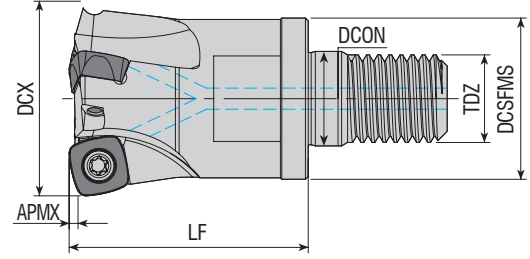

Takım Kodu Ordering Code Bestell-Bezeichnung	Stok Stock Lager	Takım Ölçüleri (mm) Dimension (mm) Abmessung (mm)							Kesici Uç Insert Wendeschneidplatte	Yedek Parçaları / Spare Parts / Ersatzteile	
		DCX	ZEFP	DC SFMS	TDZ	LF	DCON	APMX		Sıkma Vidası Screw Schraube	Tork Anahtar Torx Key Torx-Schlüssel
AHFM-SP0735-D16-M08-L23-Z02-H	●	16	2	14.75	M08	23	8.5	1.2	SPMX 073505	3108-M3x6	82-T08
AHFM-SP0735-D20-M10-L30-Z03-H	●	20	3	18	M10	30	10.5	1.2			
AHFM-SP0735-D25-M12-L35-Z04-H	●	25	4	21	M12	35	12.5	1.2			

MTSBH Ucuna Uygunur. / Compatible with MTSBH Insert. / Kompatibel mit MTSBH Wendeplatten.

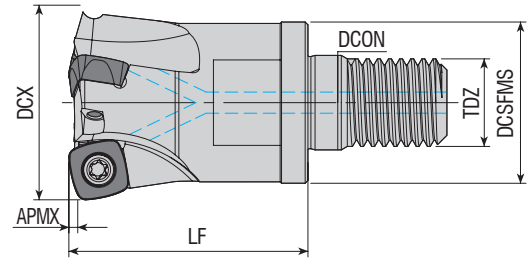

Takım Kodu Ordering Code Bestell-Bezeichnung	Stok Stock Lager	Takım Ölçüleri (mm) Dimension (mm) Abmessung (mm)							Kesici Uç Insert Wendeschneidplatte	Yedek Parçaları / Spare Parts / Ersatzteile	
		DCX	ZEFP	DC SFMS	TDZ	LF	DCON	APMX		Sıkma Vidası Screw Schraube	Tork Anahtar Torx Key Torx-Schlüssel
AHFM-SP0945-D32-M16-L43-Z04-H	●	32	4	29	M16	43	17	1.4	SPMX 094506	4115-M4x8	80-T15
AHFM-SP0945-D35-M16-L43-Z04-H	●	35	4	29	M16	43	17	1.4			
AHFM-SP0945-D42-M16-L43-Z05-H	●	42	5	29	M16	43	17	1.4			

R: Sağ / Right / Rechts L: Sol / Left / Links

● Stokta / In Stock / Auf Lager ○ Stokta Yok / Non Stock Item / Kein Lagerartikel, Lieferzeit auf Anfrage

MTSBH Ucuna Uygunur. / Compatible with MTSBH Insert. / Kompatibel mit MTSBH Wendeplatten.

Sipariş Örneği/Ordering Example/Bestellbeispiel

1 ad./pcs./stück AHFM-SP0735-D16-M08-L23-Z02-H

Kesme Hesabı : S 367 / Cutting Calculation : P 367 / Schnittberechnung : P 367

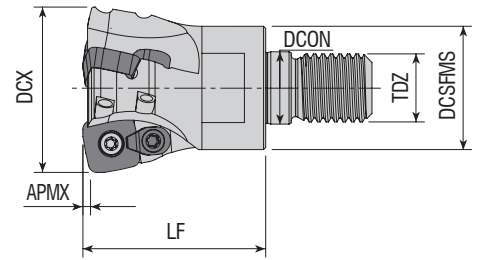

Takım Kodu Ordering Code Bestell-Bezeichnung	Stok Stock Lager	Takım Ölçüleri (mm) Dimension (mm) Abmessung (mm)						Kesici Uç Insert Wendeschneidplatte	Yedek Parçaları / Spare Parts / Ersatzteile				
		DCX	ZEFP	DCSFMS	TDZ	LF	DCON		APMX	Sıkma Vidası Screw Schraube	Baskı Parçası Wedge Clamp Spannpratze	Baskı Vidası Clamp Screw Schraube	Tork Anahtar Torx Key Torx-Schlüssel
AHFM-SD06T2-D16-M08-L23-Z02-H	●	16	2	14.75	M08	23	8.5	0.8	SD.. 06T2..	3007-M2.2x4.6	-	-	82-T07
AHFM-SD06T2-D20-M10-L30-Z03-H	●	20	3	18	M10	30	10.5	0.8					
AHFM-SD06T2-D25-M12-L35-Z04-H	●	25	4	21	M12	35	12.5	0.8					
AHFMC-SD09T3-D25-M12-L30-Z02-H	●	25	2	22	M12	30	12.5	1.4	SD.. 09T3..	3010-M3.5x9	ACK-15	1510-M3.5x9	82-T10
AHFMC-SD09T3-D32-M16-L43-Z03-H	●	32	3	29	M16	43	17	1.4					
AHFMC-SD09T3-D35-M16-L43-Z03-H	●	35	3	29	M16	43	17	1.4					
AHFMC-SD09T3-D40-M16-L43-Z04-H	●	40	4	29	M16	43	17	1.4	SD.. 1204..	4015-M4x9		4015-M3.5X11	80-T15
AHFMC-SD1204-D32-M16-L43-Z02-H	●	32	2	29	M16	43	17	1.8					
AHFMC-SD1204-D40-M16-L43-Z03-H	●	40	3	29	M16	43	17	1.8					

ZCC Ucuna Uygun. / Compatible with ZCC Insert. / Kompatibel mit ZCC Wendepplatten.

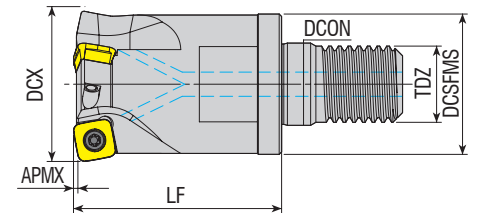

Takım Kodu Ordering Code Bestell-Bezeichnung	Stok Stock Lager	Takım Ölçüleri (mm) Dimension (mm) Abmessung (mm)						Kesici Uç Insert Wendeschneidplatte	Yedek Parçaları / Spare Parts / Ersatzteile				
		DCX	ZEFP	DCSFMS	TDZ	LF	DCON		APMX	Sıkma Vidası Screw Schraube	Baskı Parçası Wedge Clamp Spannpratze	Baskı Vidası Clamp Screw Schraube	Tork Anahtar Torx Key Torx-Schlüssel
AHFM-S00803-D20-M10-L30-Z02-H	●	20	2	18	M10	30	10.5	1	SOMW 0803..	4010-M3X8	-	-	82-T10
AHFM-S00803-D25-M12-L35-Z03-H	●	25	3	22	M12	35	12.5	1					
AHFM-S00803-D32-M16-L43-Z03-H	●	32	3	29	M16	43	17	1					
AHFM-S00803-D32-M16-L43-Z04-H	●	32	4	29	M16	43	17	1					
AHFM-S00803-D40-M16-L43-Z04-H	●	40	4	29	M16	43	17	1					

R: Sağ / Right / Rechts/ L: Sol / Left / Links

● Stokta / In Stock / Auf Lager ○ Stokta Yok / Non Stock Item / Kein Lagerartikel, Lieferzeit auf Anfrage

KPTK Ucuna Uygun. / Compatible with KPTK Insert. / Kompatibel mit KPTK Wendepplatten.

Sipariş Örneği/Ordering Example/Bestellbeispiel  
1 ad./pcs./stück AHFM-SD06T2-D16-M08-L23-Z02-H

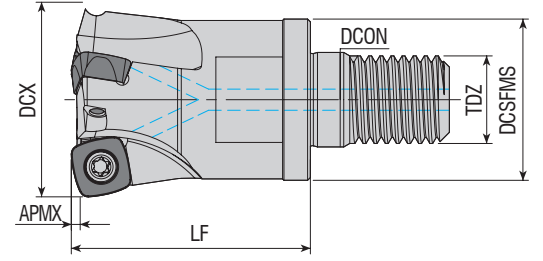

Takım Kodu Ordering Code Bestell-Bezeichnung	Stok Stock Lager	Takım Ölçüleri (mm) Dimension (mm) Abmessung (mm)							Kesici Uç Insert Wendeschneidplatte	Yedek Parçaları / Spare Parts / Ersatzteile		
		DCX	ZEPF	DC SFMS	TDZ	LF	DCON	APMX		Sıkma Vidası Screw Schraube	Tork Anahtar Torx Key Torx-Schlüssel	
AHFM-SO0803P-D32-M16-L35-Z04-H	●	32	4	29	M16	35	17	1	SOEW 0803	4010-M3x8	82-T10	
AHFM-SO0803P-D42-M16-L35-Z05-H	●	42	5	29	M16	35	17	1				

PLBT Ucuna Uygunur. / Compatible with PLBT Insert. / Kompatibel mit PLBT Wendeplatten.

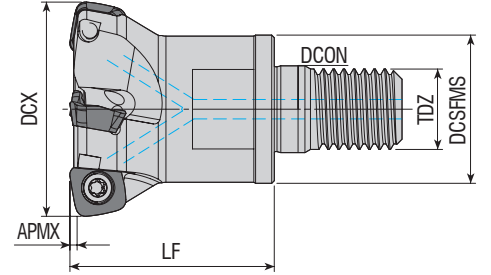

Takım Kodu Ordering Code Bestell-Bezeichnung	Stok Stock Lager	Takım Ölçüleri (mm) Dimension (mm) Abmessung (mm)							Kesici Uç Insert Wendeschneidplatte	Yedek Parçaları / Spare Parts / Ersatzteile			
		DCX	ZEPF	DCSFMS	TDZ	LF	DCON	APMX		Sıkma Vidası Screw Schraube	Baskı Parçası Wedge Clamp Spannpratze	Baskı Vidası Clamp Screw Schraube	Tork Anahtar Torx Key Torx-Schlüssel
AHFM-SO1004-D32-M16-L40-Z03-H	●	32	3	29	M16	40	17	1.5	SOMT 1004..	4015-M4x9	-	-	80-T15
AHFM-SO1004-D40-M16-L40-Z04-H	●	40	4	29	M16	40	17	1.5					
AHFM-SO1004-D42-M16-L40-Z04-H	●	42	4	29	M16	40	17	1.5					

KYCR Ucuna Uygunur. / Compatible with KYCR Insert. / Kompatibel mit KYCR Wendeplatten.

Sipariş Örneği/Ordering Example/Bestellbeispiel

1 ad./pcs./stück AHFM-SO0803P-D32-M16-L35-Z04-H  
Kesme Hesabı : S 377/ Cutting Calculation : P 377 / Schnittberechnung : P 377

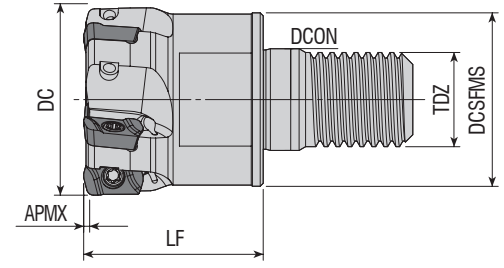

Takım Kodu Ordering Code Bestell-Bezeichnung	Stok Stock Lager	Takım Ölçüleri (mm) Dimension (mm) Abmessung (mm)							Kesici Uç Insert Wendeschneidplatte	Yedek Parçaları / Spare Parts / Ersatzteile			
		DC	ZEPF	DCSFMS	TDZ	LF	DCON	APMX		Sıkma Vidası Screw Schraube	Baskı Parçası Wedge Clamp Spannpratze	Baskı Vidası Clamp Screw Schraube	Tork Anahtar Torx Key Torx-Schlüssel
AHFM-YP1003-D16-M08-L23-Z02-F	●	16	2	14.75	M08	23	8.5	1	EP. 1003.. ZPMT 1003.. YPHW 1003..	3008-M2.5x5	-	-	82-T08
AHFM-YP1003-D16-M08-L23-Z02-H-F	●	16	2	14.75	M08	23	8.5	1					
AHFM-YP1003-D17-M08-L23-Z02-H	●	17	2	14.75	M08	23	8.5	1					
AHFM-YP1003-D17-M08-L23-Z02-H-F	●	17	2	14.75	M08	23	8.5	1					
AHFM-YP1003-D20-M10-L30-Z03-H	●	20	3	18	M10	30	10.5	1					
AHFM-YP1003-D20-M10-L30-Z03-H-F	●	20	3	18	M10	30	10.5	1					
AHFM-YP1003-D20-M10-L30-Z04-H	●	20	4	18	M10	30	10.5	1					
AHFM-YP1003-D20-M10-L30-Z04-F	●	20	4	18	M10	30	10.5	1					
AHFM-YP1003-D21-M10-L30-Z03-H	●	21	3	18	M10	30	10.5	1					
AHFM-YP1003-D21-M10-L30-Z03-H-F	●	21	3	18	M10	30	10.5	1					
AHFM-YP1003-D25-M12-L35-Z04-H	●	25	4	21	M12	35	12.5	1					
AHFM-YP1003-D25-M12-L35-Z04-F	●	25	4	21	M12	35	12.5	1					
AHFM-YP1003-D25-M12-L35-Z04-H-F	●	25	4	21	M12	35	12.5	1					
AHFM-YP1003-D26-M12-L35-Z04-H-F	●	26	4	21	M12	35	12.5	1					
AHFM-YP1003-D32-M16-L30-Z05-F	●	32	5	29	M16	30	17	1					
AHFM-YP1003-D32-M16-L43-Z05-H-F	●	32	5	29	M16	43	17	1					
AHFM-YP1003-D40-M16-L43-Z06-H-F	●	40	6	29	M16	43	17	1					
AHFM-YP1003-D42-M16-L43-Z06-H-F	●	42	6	29	M16	43	17	1					

R: Sağ / Right / Rechts/ L: Sol / Left / Links

● Stokta / In Stock / Auf Lager ○ Stokta Yok / Non Stock Item / Kein Lagerartikel, Lieferzeit auf Anfrage  
DJT Ucuna Uygun. / Compatible with DJT Insert. / Kompatibel mit DJT Wendepplatten.

Çap Ölçüsü - 0,02 mm Olarak üretiliyor. F: ± 0,02 mm Demektir. Ör: Ø16 Takım 15,98 ± 0,02 mm yani 16,00 mm - 15,96 mm Olmalıdır.

Diameter Size is produced as - 0.02 mm. F: means ± 0,02 mm. For example: Ø16 tool 15.98 ± 0.02 mm, it means that it should be 16.00 mm - 15.96 mm.

Durchmesser - Es wird mit -0,02 mm hergestellt. Das heißt F: ± 0,02 mm. Zum Beispiel: Der Ø16-Satz sollte 15,98 ± 0,02 mm, 16,00 mm - 15,96 mm betragen.

Sipariş Örneği/Ordering Example/Bestellbeispiel

1 ad./pcs./stück AHFM-YP1003-D16-M08-L23-Z02-F

Kesme Hesabı : S 377 / Cutting Calculation : P 377 / Schnittberechnung : P 377

Sıkma Tork Değeri : S 376 / Tightening Torque : P 376 / Anzugsmoment : P 376

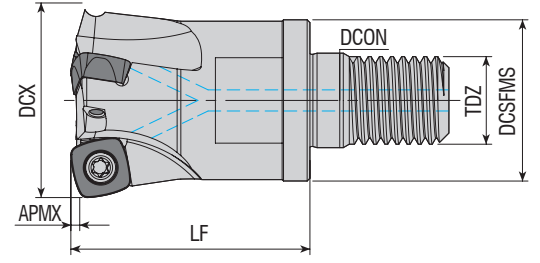

Takım Kodu Ordering Code Bestell-Bezeichnung	Stok Stock Lager	Takım Ölçüleri (mm) Dimension (mm) Abmessung (mm)							Kesici Uç Insert Wendeschneidplatte	Yedek Parçaları / Spare Parts / Ersatzteile			
		DCX	ZEFP	DCSFMS	TDZ	LF	DCON	APMX		Sıkma Vidası Screw Schraube	Baskı Parçası Wedge Clamp Spannpratze	Baskı Vidası Clamp Screw Schraube	Tork Anahtar Torx Key Torx-Schlüssel
AHFM-SP1004-D25-M12-L35-Z02-H	●	25	2	21	M12	35	12.5	1	SPNW 1004..		-	-	80-T15
AHFM-SP1004-D32-M16-L43-Z03-H	●	32	3	29	M16	43	17	1.5					
AHFM-SP1004-D35-M16-L43-Z03-H	●	35	3	29	M16	43	17	1.5					
AHFM-SP1004-D42-M16-L43-Z04-H	●	42	4	29	M16	43	17	1.5					

DJT Ucuna Uygunur. / Compatible with DJT Insert. / Kompatibel mit DJT Wendeplatten.

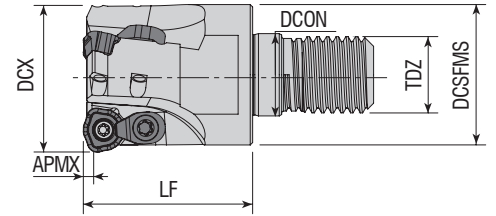

Takım Kodu Ordering Code Bestell-Bezeichnung	Stok Stock Lager	Takım Ölçüleri (mm) Dimension (mm) Abmessung (mm)							Kesici Uç Insert Wendeschneidplatte	Yedek Parçaları / Spare Parts / Ersatzteile			
		DCX	ZEFP	DCSFMS	TDZ	LF	DCON	APMX		Sıkma Vidası Screw Schraube	Baskı Parçası Wedge Clamp Spannpratze	Baskı Vidası Clamp Screw Schraube	Tork Anahtar Torx Key Torx-Schlüssel
AHFMC-WD0804-D25-M12-L35-Z02-H	●	25	2	21	M12	35	12.5	1.5	WDMT 0804..		ACK-15	4010-M3x8	82-T10
AHFMC-WD0804-D32-M16-L35-Z03-H	●	32	3	29	M16	35	17	1.5					

R: Sağ / Right / Rechts/ L: Sol / Left / Links

● Stokta / In Stock / Auf Lager ○ Stokta Yok / Non Stock Item / Kein Lagerartikel, Lieferzeit auf Anfrage

SMTM Ucuna Uygunur. / Compatible with SMTM Insert. / Kompatibel mit SMTM Wendeplatten.

Sipariş Örneği/Ordering Example/Bestellbeispiel

1 ad./pcs./stück AHFM-SP1004-D25-M12-L35-Z02-H

Kesme Hesabı : S 377 / Cutting Calculation : P 377 / Schnittberechnung : P 377

Sıkma Tork Değeri : S 376 / Tightening Torque : P 376 / Anzugsmoment : P 376

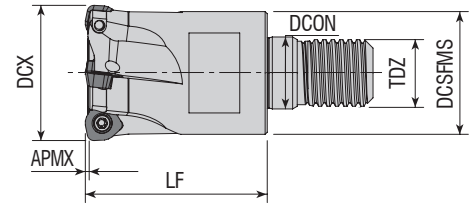

Takım Kodu Ordering Code Bestell-Bezeichnung	Stok Stock Lager	Takım Ölçüleri (mm) Dimension (mm) Abmessung (mm)							Kesici Uç Insert Wendeschneidplatte	Yedek Parçaları / Spare Parts / Ersatzteile			
		DCX	ZEFP	DCSFMS	TDZ	LF	DCON	APMX		Sıkma Vidası Screw Schraube	Baskı Parçası Wedge Clamp Spannpratze	Baskı Vidası Clamp Screw Schraube	Tork Anahtar Torx Key Torx-Schlüssel
AHFM-WD0503D-D20-M10-L30-Z02-H	●	20	2	18	M10	30	10.5	1.25	WDMT 0503..	4010-M3x6	-	-	82-T10
AHFM-WD0503D-D25-M12-L35-Z03-H	●	25	3	21	M12	35	12.5	1.25		4010-M3x8	-	-	
AHFM-WD0503D-D32-M16-L43-Z04-H	●	32	4	29	M16	43	17	1.25		-	-	-	
AHFM-WD0503D-D40-M16-L43-Z05-H	●	40	5	29	M16	43	17	1.25		-	-	-	
AHFMC-WD06T3D-D35-M16-L43-Z03-H	●	35	3	29	M16	43	17	1.5	WDHW 06T3..	3015-M3.5x9	ACK-15	4015-M3.5x11	80-T15
AHFMC-WD0805D-D32-M16-L43-Z02-H	●	32	2	29	M16	43	17	2	WDHW 0805..	4020-M4.5x10	ACK-19	4020-M4.5x12	

DJT Ucuna Uygun. / Compatible with DJT Insert. / Kompatibel mit DJT Wendeplatten.

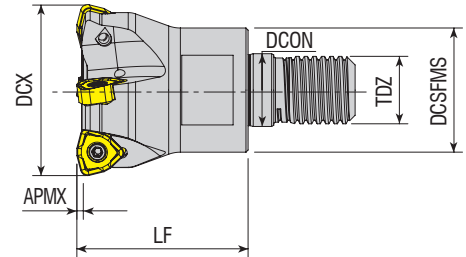

Takım Kodu Ordering Code Bestell-Bezeichnung	Stok Stock Lager	Takım Ölçüleri (mm) Dimension (mm) Abmessung (mm)							Kesici Uç Insert Wendeschneidplatte	Yedek Parçaları / Spare Parts / Ersatzteile		
		DCX	ZEFP	DCSFMS	TDZ	LF	DCON	APMX		Sıkma Vidası Screw Schraube	Tork Anahtar Torx Key Torx-Schlüssel	
AHFM-WN09T3-D32-M16-L40-Z03-H	●	32	3	29	M16	40	17	1.5	WNMX 09T3..	4010-M3x8	82-T10	
new AHFM-WN09T3-D35-M16-L40-Z04-H	●	35	4	26	M16	40	17	1.5				
AHFM-WN09T3-D40-M16-L40-Z04-H	●	40	4	29	M16	40	17	1.5				

R: Sağ / Right / Rechtsl L: Sol / Left / Links

● Stokta / In Stock / Auf Lager ○ Stokta Yok / Non Stock Item / Kein Lagerartikel, Lieferzeit auf Anfrage

KRLY Ucuna Uygun. / Compatible with KRLY Insert. / Kompatibel mit KRLY Wendeplatten.

Sipariş Örneği/Ordering Example/Bestellbeispiel

1 ad./pcs./stück AHFM-WD0503D-D20-M10-L30-Z02-H

Kesme Hesabı : S 377 / Cutting Calculation : P 377 / Schnittberechnung : P 377

Sıkma Tork Değeri : S 376 / Tightening Torque : P 376 / Anzugsmoment : P 376

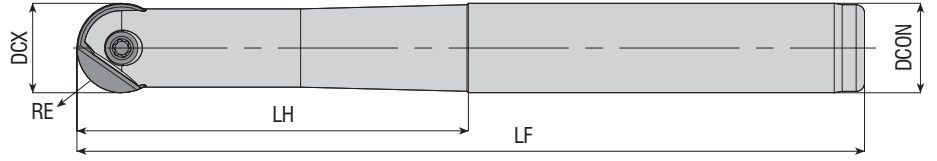

Takım Kodu Ordering Code Bestell-Bezeichnung	Stok Stock Lager	Takım Ölçüleri (mm) Dimension (mm) Abmessung (mm)					Kesici Uç Insert Wendeschneidplatte	Yedek Parçaları / Spare Parts / Ersatzteile	
		DCX	RE	DCON	LF	LH		Sıkma Vidası Screw Schraube	Tork Anahtar Torx Key Torx-Schlüssel
APMR-BNM12-D12-C12-L130	●	12	6	12	130	32			
APMR-BNM16-D16-C16-L175	●	16	8	16	175	70			
APMR-BNM16-D16-C16-L200	●	16	8	16	200	100			
APMR-BNM20-D20-C20-L160	●	20	10	20	160	70			
APMR-BNM20-D20-C20-L200	●	20	10	20	200	100			
APMR-BNM20-D20-C20-L250	●	20	10	20	250	150			
APMR-BNM25-D25-C25-L160	●	25	12.5	25	160	70			
APMR-BNM25-D25-C25-L200	●	25	12.5	25	200	100			
APMR-BNM25-D25-C25-L250	●	25	12.5	25	250	150			

DJT Ucuna Uygundur. / Compatible with DJT Insert. / Kompatibel mit DJT Wendeplatten.

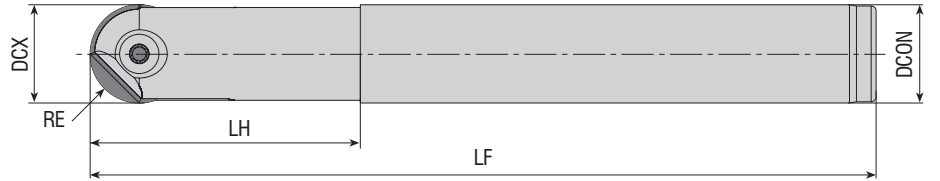

Takım Kodu Ordering Code Bestell-Bezeichnung	Stok Stock Lager	Takım Ölçüleri (mm) Dimension (mm) Abmessung (mm)					Kesici Uç Insert Wendeschneidplatte	Yedek Parçaları / Spare Parts / Ersatzteile	
		DCX	RE	DCON	LF	LH		Sıkma Vidası Screw Schraube	Tork Anahtar Torx Key Torx-Schlüssel
APMR-RO12-D12-C12-L120	●	12	6	12	120	35			
APMR-RO12-D12-C16-L160	●	12	6	16	160	50			
APMR-RO16-D16-C16-L160	●	16	8	16	160	45			
APMR-RO16-D16-C16-L200	●	16	8	16	200	45			
APMR-RO16-D16-C20-L200	●	16	8	20	200	65			
APMR-RO20-D20-C20-L160	●	20	10	20	160	55			
APMR-RO20-D20-C20-L200	●	20	10	20	200	55			
APMR-RO20-D20-C25-L220	●	20	10	25	220	80			

R: Sağ / Right / Rechts L: Sol / Left / Links

● Stokta / In Stock / Auf Lager ○ Stokta Yok / Non Stock Item / Kein Lagerartikel, Lieferzeit auf Anfrage

ZCC Ucuna Uygundur. / Compatible with ZCC Insert. / Kompatibel mit ZCC Wendeplatten.

Sipariş Örneği/Ordering Example/Bestellbeispiel

1 ad./pcs./stück APMR-BNM12-D12-C12-L130

Kesme Hesabı : S 377/ Cutting Calculation : P 377 / Schnittberechnung : P 377



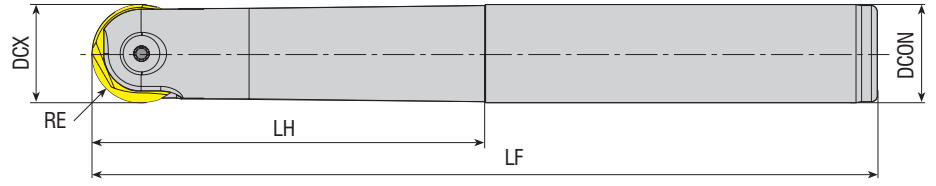

Takım Kodu Ordering Code Bestell-Bezeichnung	Stok Stock Lager	Takım Ölçüleri (mm) Dimension (mm) Abmessung (mm)					Kesici Uç Insert Wendeschneidplatte	Yedek Parçaları / Spare Parts / Ersatzteile	
		DCX	RE	DCON	LF	LH		Sıkma Vidası Screw Schraube	Tork Anahtar Torx Key Torx-Schlüssel
APMR-P3208-D08-C10-L110	●	8	4	10	110	25		1208-M3x7	82-T08
APMR-P3210-D10-C10-L130	●	10	5	10	130	30		1215-M4x0.5x9	80-T15
APMR-P3210-D10-C12-L130	●	10	5	12	130	30		1220-M5x0.5x9	80-T20
APMR-P3212-D12-C12-L130	●	12	6	12	130	32		1220-M5x0.5x12	
APMR-P3216-D16-C16-L175	●	16	8	16	175	75		1220-M5x0.5x15	80-T20
APMR-P3220-D20-C20-L200	●	20	10	20	200	100		1220-M6x0.75x20	
APMR-P3225-D25-C25-L200	●	25	12.5	25	200	100		1204-M8x0.75x26	AAL-05-4
APMR-P3232-D32-C32-L200	●	32	16	32	200	100			

WLTR Ucuna Uygun. / Compatible with WLTR Insert. / Kompatibel mit WLTR Wendeplatten.

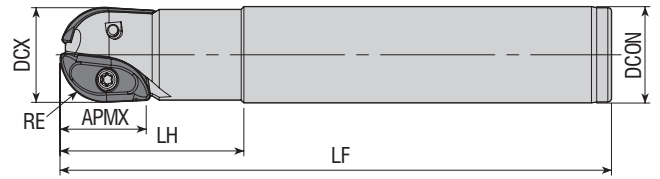

Takım Kodu Ordering Code Bestell-Bezeichnung	Stok Stock Lager	Takım Ölçüleri (mm) Dimension (mm) Abmessung (mm)						Kesici Uç Insert Wendeschneidplatte	Yedek Parçaları / Spare Parts / Ersatzteile	
		DCX	RE	DCON	LF	LH	APMX		Sıkma Vidası Screw Schraube	Tork Anahtar Torx Key Torx-Schlüssel
APMR-XP16-D16-C16-L150	●	16	8	16	150	40	16		3008-M2.5x6	82-T08
APMR-XP20-D20-C20-L150	●	20	10	20	150	50	20		3010-M3.5x7	82-T10
APMR-XP25-D25-C25-L150	●	25	12.5	25	150	50	25		4015-M4x9	80-T15

R: Sağ / Right / Rechts/ L: Sol / Left / Links

● Stokta / In Stock / Auf Lager ○ Stokta Yok / Non Stock Item / Kein Lagerartikel, Lieferzeit auf Anfrage



ZCC Ucuna Uygun. / Compatible with ZCC Insert. / Kompatibel mit ZCC Wendeplatten.

Sipariş Örneği/Ordering Example/Bestellbeispiel

1 ad./pcs./stück APMR-P3208-D08-C10-L110

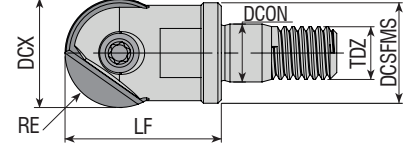

Kesme Hesabı : S 377/ Cutting Calculation : P 377 / Schnittberechnung : P 377

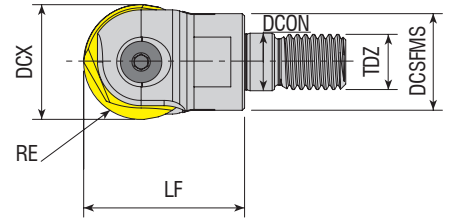

Takım Kodu Ordering Code Bestell-Bezeichnung	Stok Stock Lager	Takım Ölçüleri (mm) Dimension (mm) Abmessung (mm)						Kesici Uç Insert Wendeschneidplatte	Yedek Parçaları / Spare Parts / Ersatzteile		
		DCX	RE	DCSFMS	TDZ	LF	DCON		Sıkma Vidası Screw Schraube	Tork Anahtar Torx Key Torx-Schlüssel	
APMR-BNM12-D12-M06-L20	●	12	6	11	M06	20	6.5				
APMR-BNM16-D16-M08-L23	●	16	8	14.75	M08	23	8.5	<b>BNM 120-S</b>	1210-M3.5x9.6	82-T10	
APMR-BNM20-D20-M10-L30	●	20	10	18	M10	30	10.5	<b>BNM 160-S</b>	1215-M4x13.5	80-T15	
								<b>BNM 200-S</b>	1220-M5x0.5x15	80-T20	

DJT Ucuna Uygunudur. / Compatible with DJT Insert. / Kompatibel mit DJT Wendeplatten.



Takım Kodu Ordering Code Bestell-Bezeichnung	Stok Stock Lager	Takım Ölçüleri (mm) Dimension (mm) Abmessung (mm)						Kesici Uç Insert Wendeschneidplatte	Yedek Parçaları / Spare Parts / Ersatzteile		
		DCX	RE	DCSFMS	TDZ	LF	DCON		Sıkma Vidası Screw Schraube	Tork Anahtar Torx Key Torx-Schlüssel	
APMR-P3216-D16-M08-L25	●	16	8	14	M08	25	8.5				
APMR-P3220-D20-M10-L30	●	20	10	18	M10	30	10.5	<b>P3216</b>	1220-M5x0.5x12	80-T20	
APMR-P3225-D25-M12-L35	●	25	12.5	21	M12	35	12.5	<b>P3220</b>	1220-M5x0.5x15		
APMR-P3232-D32-M16-L43	●	32	16	30	M16	43	17	<b>P3225</b>	1220-M6x0.75x20	AAL-05-4	
								<b>P3232</b>	1204-M8x0.75x26		

R: Sağ / Right / Rechts L: Sol / Left / Links

● Stokta / In Stock / Auf Lager ○ Stokta Yok / Non Stock Item / Kein Lagerartikel, Lieferzeit auf Anfrage

WLTR Ucuna Uygunudur. / Compatible with WLTR Insert. / Kompatibel mit WLTR Wendeplatten.

Sipariş Örneği/Ordering Example/Bestellbeispiel

1 ad./pcs./stück APMR-BNM12-D12-M06-L20

Kesme Hesabı : S 377 / Cutting Calculation : P 377 / Schnittberechnung : P 377

Sıkma Tork Değeri : S 376 / Tightening Torque : P 376 / Anzugsmoment : P 376

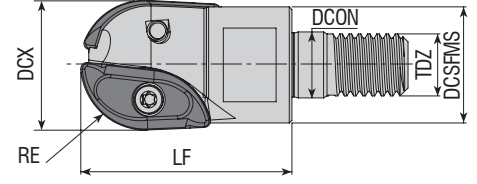

Takım Kodu Ordering Code Bestell-Bezeichnung	Stok Stock Lager	Takım Ölçüleri (mm) Dimension (mm) Abmessung (mm)						Kesici Uç Insert Wendeschneidplatte	Yedek Parçaları / Spare Parts / Ersatzteile			
		DCX	RE	DCSFMS	TDZ	LF	DCON		Sıkma Vidası Screw Schraube	Tork Anahtar Torx Key Torx-Schlüssel		
APMR-SWB225-D25-M12-L35	●	25	12.5	23.5	M12	35	12.5		4015-M4x9	80-T15		
APMR-SWB230-D30-M16-L43	●	30	15	28	M16	43	17				1020-M5x11	80-T20
APMR-SWB232-D32-M16-L43	●	32	16	30	M16	43	17					

DJT Ucuna Uygunur. / Compatible with DJT Insert. / Kompatibel mit DJT Wendeplatten.

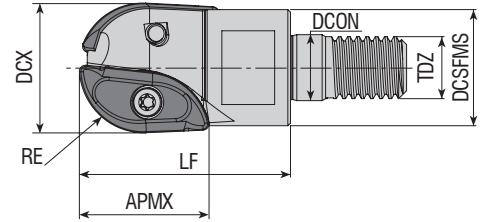

Takım Kodu Ordering Code Bestell-Bezeichnung	Stok Stock Lager	Takım Ölçüleri (mm) Dimension (mm) Abmessung (mm)							Kesici Uç Insert Wendeschneidplatte	Yedek Parçaları / Spare Parts / Ersatzteile			
		DCX	RE	DCSFMS	TDZ	LF	APMX	DCON		Sıkma Vidası Screw Schraube	Tork Anahtar Torx Key Torx-Schlüssel		
APMR-XP16-D16-M08-L25	●	16	8	14.75	M08	25	16	8.5		3008-M2.5x6	82-T08		
APMR-XP20-D20-M10-L30	●	20	10	18	M10	30	20	10.5				3010-M3.5x7	82-T10
APMR-XP25-D25-M12-L40	●	25	12.5	22	M12	40	25	12.5					

R: Sağ / Right / Rechts/ L: Sol / Left / Links

● Stokta / In Stock / Auf Lager ○ Stokta Yok / Non Stock Item / Kein Lagerartikel, Lieferzeit auf Anfrage

ZCC Ucuna Uygunur. / Compatible with ZCC Insert. / Kompatibel mit ZCC Wendeplatten.

Sipariş Örneği/Ordering Example/Bestellbeispiel

1 ad./pcs./stück APMR-SWB225-D25-M12-L35

Kesme Hesabı : S 377 / Cutting Calculation : P 377 / Schnittberechnung : P 377

Sıkma Tork Değeri : S 376 / Tightening Torque : P 376 / Anzugsmoment : P 376

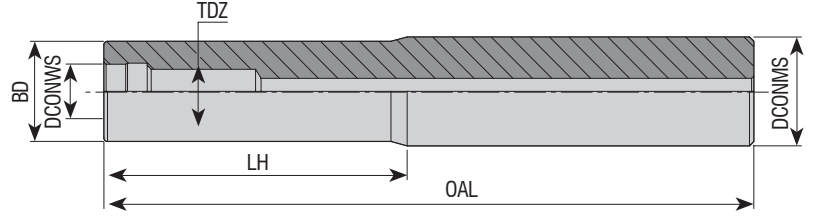

Takım Kodu Ordering Code Bestell-Bezeichnung	Stok Stock Lager	Takım Ölçüleri (mm) Dimension (mm) Abmessung (mm)					
		DCONMS	TDZ	DCONWS	BD	OAL	LH
AVTT-D13-C16-M08-L100-H	●	16	M08	8.5	13	100	40
AVTT-D15-C16-M08-L130-H	●	16	M08	8.5	15	130	70
AVTT-D18-C20-M10-L130-H	●	20	M10	10.5	18	130	70
AVTT-D18-C20-M10-L160-H	●	20	M10	10.5	18	160	80
AVTT-D23-C25-M12-L150-H	●	25	M12	12.5	23	150	70
AVTT-D23-C25-M12-L200-H	●	25	M12	12.5	23	200	100
AVTT-D23-C25-M12-L250-H	●	25	M12	12.5	23	250	150
AVTT-D30-C32-M16-L150-H	●	32	M16	17	30	150	70
AVTT-D30-C32-M16-L200-H	●	32	M16	17	30	200	100
AVTT-D30-C32-M16-L250-H	●	32	M16	17	30	250	150
AVTT-D30-C32-M16-L300-H	●	32	M16	17	30	300	200

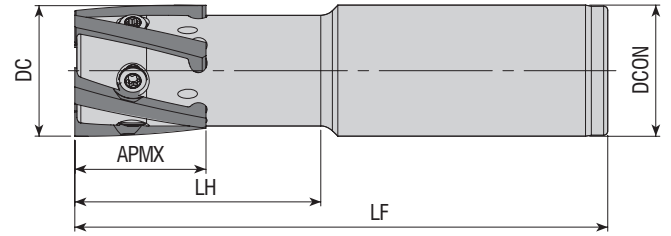

Takım Kodu Ordering Code Bestell-Bezeichnung	Stok Stock Lager	Takım Ölçüleri (mm) Dimension (mm) Abmessung (mm)						Kesici Uç Insert Wendeschneidplatte	Yedek Parçaları / Spare Parts / Ersatzteile	
		DC	ZEFP	DCON	LF	LH	APMX		Sıkma Vidası Screw Schraube	Tork Anahtar Torx Key Torx-Schlüssel
ATM-H23-D23-C25-L100-Z02-H	●	23	2	25	100	30	27	H23	1015-M4x8	80-T15
ATM-H32-D32-C32-L130-Z05-H	●	32	5	32	130	35	32	H32	1720-U8-32x10	80-T20

R: Sağ / Right / Rechts/ L: Sol / Left / Links

● Stokta / In Stock / Auf Lager ○ Stokta Yok / Non Stock Item / Kein Lagerartikel, Lieferzeit auf Anfrage

CPT Ucuna Uygundur. / Compatible with CPT Insert. / Kompatibel mit CPT Wendepalten.

Sipariş Örneği/Ordering Example/Bestellbeispiel

1 ad./pcs./stück AVTT-D13-C16-M08-L100-H

Kesme Hesabı : S 377/ Cutting Calculation : P 377 / Schnittberechnung : P 377

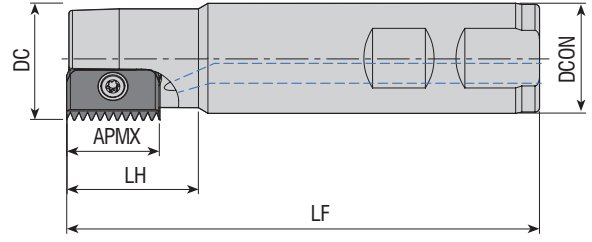

Takım Kodu Ordering Code Bestell-Bezeichnung	Stok Stock Lager	Takım Ölçüleri (mm) Dimension (mm) Abmessung (mm)						Kesici Uç Insert Wendeschneidplatte	Yedek Parçaları / Spare Parts / Ersatzteile		
		DC	ZAFP	DCON	LF	LH	APMX		Sıkma Vidası Screw Schraube	Tork Anahtar Torx Key Torx-Schlüssel	
ATM-C14-D14-W20-L100-Z01-H	●	14	1	20	100	25	14				
ATM-C21-D18-W20-L100-Z01-H	●	18	1	20	100	30	21				
ATM-C21-D21-W25-L125-Z01-H	●	21	1	25	125	40	21				
ATM-C21-D25-W20-L125-Z01-H	●	25	1	20	125	30	21				
ATM-C21-D28-W25-L90-Z01-H	●	28	1	25	90	30	21				
ATM-C21-D38-W32-L90-Z03-H	●	38	3	32	90	30	21				
ATM-C21-D38-W32-L120-Z03-H	●	38	3	32	120	30	21				
ATM-C21-D43-W32-L90-Z03-H	●	43	3	32	90	30	21				
ATM-C30-D29-W25-L150-Z01-H	●	29	1	25	150	50	30				

CPT Ucuna Uygunur. / Compatible with CPT Insert. / Kompatibel mit CPT Wendeplatten.

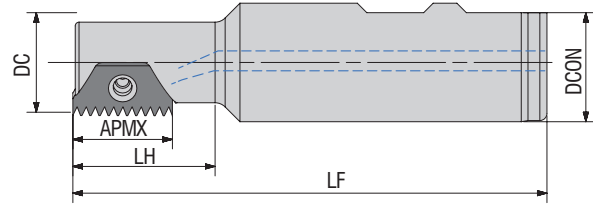



Takım Kodu Ordering Code Bestell-Bezeichnung	Stok Stock Lager	Takım Ölçüleri (mm) Dimension (mm) Abmessung (mm)						Kesici Uç Insert Wendeschneidplatte	Yedek Parçaları / Spare Parts / Ersatzteile		
		DC	ZAFP	DCON	LF	LH	APMX		Sıkma Vidası Screw Schraube	Tork Anahtar Torx Key Torx-Schlüssel	
ATM-3BEI-D21-W25-L100-Z01-H	●	21	1	25	100	30	21				
ATM-3EI-D14-W20-L90-Z01-H	●	14	1	20	90	22	15.3				
ATM-3EI-D20-W25-L120-Z01-H	●	20	1	25	120	25	15.3				

VRGS Ucuna Uygunur. / Compatible with VRGS Insert. / Kompatibel mit VRGS Wendeplatten.

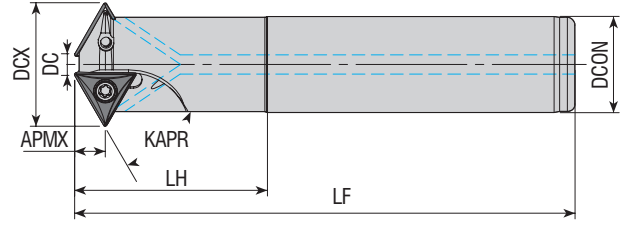

Sipariş Örneği/Ordering Example/Bestellbeispiel  
1 ad./pcs./stück ATM-C14-D14-W20-L100-Z01-H  
Kesme Hesabı : S 377 / Cutting Calculation : P 377 / Schnittberechnung : P 377

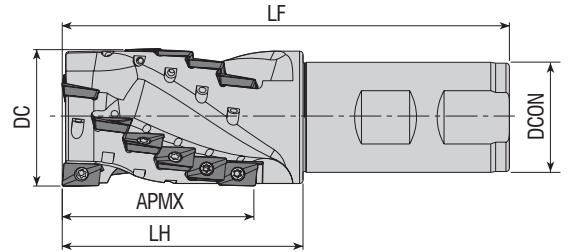
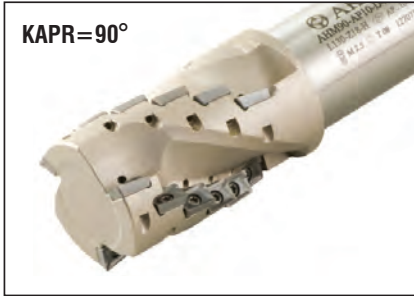

Takım Kodu Ordering Code Bestell-Bezeichnung	Stok Stock Lager	Takım Ölçüleri (mm) Dimension (mm) Abmessung (mm)							Kesici Uç Insert Wendeschneidplatte	Yedek Parçaları / Spare Parts / Ersatzteile		
		KAPR	DCX	DCON	DC	LF	LH	ZEPF		APMX	Sıkma Vidası Screw Schraube	Tork Anahtar Torx Key Torx-Schlüssel
ATM60-TB0601-D13-C10-L150-Z02-H	●	60	13	10	2.5	150	40	2	3.3			
ATM60-TC0902-D20.5-C16-L150-Z02-H	●	60	20.5	16	5.2	150	40	2	4.7	<b>TBGT 060102</b>	3006-M2x4	82-T06
ATM60-TC1102-D26-C20-L150-Z03-H	●	60	26	20	8.3	150	50	3	5.4	<b>TC.T 090202</b>	3007-M2.2x4.6	82-T07
ATM60-TC16T3-D32-C25-L150-Z02-H	●	60	32	25	6.4	150	50	2	8	<b>TC.T 110202</b>	3008-M2.5x6	82-T08
ATM60-TC16T3-D40-C32-L250-Z03-H	●	60	40	32	13.7	250	50	3	8	<b>TC.T 16T304</b>	4015-M3.5x9	80-T15

ISO Ucuna Uygun. / Compatible with ISO Insert. / Kompatibel mit ISO Wendeplatten.



Takım Kodu Ordering Code Bestell-Bezeichnung	Stok Stock Lager	Takım Ölçüleri (mm) Dimension (mm) Abmessung (mm)							Kesici Uç Insert Wendeschneidplatte	Yedek Parçaları / Spare Parts / Ersatzteile		
		ZEFP		DC	DCON	APMX	LH	LF				
Toplam Total Gesamt	Etkili Effective Effektiv											
AHM90-AP10-D20-W20-L087-Z0204	●	4	2	20	20	28	37	87	<b>AP. 1003..</b>	3008-M2.5x6	82-T08	
AHM90-AP10-D20-W20-L087-Z0206	●	6	2	20	20	28	37	87				
AHM90-AP10-D25-W25-L105-Z0208-H	●	8	2	25	25	37	50	105				
AHM90-AP10-D32-W32-L115-Z0315-H	●	15	3	32	32	46	55	115				
AHM90-AP10-D40-W32-L130-Z0318-H	●	18	3	40	32	55	70	130				

ISO Ucuna Uygun. / Compatible with ISO Insert. / Kompatibel mit ISO Wendeplatten.

Sipariş Örneği/Ordering Example/Bestellbeispiel

1 ad./pcs./stück ATM60-TB0601-D13-C10-L150-Z02-H  
Kesme Hesabı : S 377/ Cutting Calculation : P 377 / Schnittberechnung : P 377

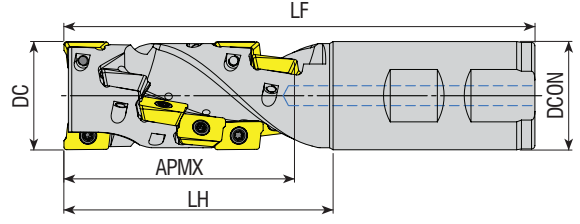
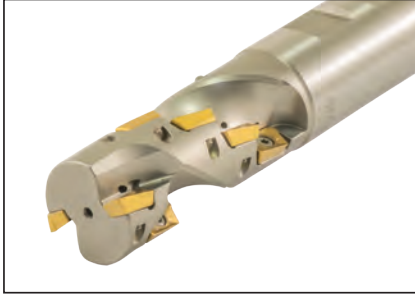

**Takım Kodu**  
**Ordering Code**  
**Bestell-Bezeichnung**

Stok  
Stock  
Lager

ZEFP  
Toplam  
Total  
Gesamt

Etkili  
Effective  
Effektiv

DC

DCON

APMX

LH

LF

Takım Ölçüleri (mm)  
Dimension (mm)  
Abmessung (mm)

Kesici Uç  
Insert  
Wendeschneidplatte

Yedek Parçaları / Spare Parts / Ersatzteile

Sıkma Vidası  
Screw  
Schraube

Tork Anahtar  
Torx Key  
Torx-Schlüssel

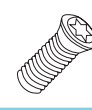

AHM90-AP1204-D32-W32-L140-Z0212-H  
AHM90-AP1204-D40-W32-L160-Z0321-H

●

12

2

32

32

68

80

140

●

21

3

40

32

79

100

160

AP. 1204..

3010-M3.5x9

82-T10

R: Sağ / Right / Rechts L: Sol / Left / Links

● Stokta / In Stock / Auf Lager ○ Stokta Yok / Non Stock Item / Kein Lagerartikel, Lieferzeit auf Anfrage  
TGTC Ucuna Uygunudur. / Compatible with TGTC Insert. / Kompatibel mit TGTC Wendeplatten.

Sipariş Örneği/Ordering Example/Bestellbeispiel

1 ad./pcs./stück AHM90-AP1204-D32-W32-L140-Z0212-H

Kesme Hesabı : S 377/ Cutting Calculation : P 377 / Schnittberechnung : P 377



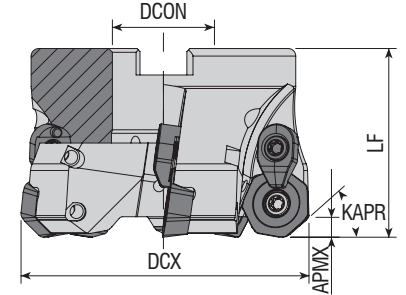

Takım Kodu Ordering Code Bestell-Bezeichnung	Stok Stock Lager	Takım Ölçüleri (mm) Dimension (mm) Abmessung (mm)					Kesici Uç Insert Wendeschneidplatte	Yedek Parçaları / Spare Parts / Ersatzteile				
		DCX	ZEPF	DCON	LF	APMX		Sıkma Vidası Screw Schraube	Baskı Parçası Wedge Clamp Spannpratze	Baskı Vidası Clamp Screw Klemmschraube	Tork Anahtar Torx Key Torx-Schlüssel	Montaj Vidası Mounting Screw Befestigungsschraube
AFM42C-XD0806-D063-A27-Z04-H	●	63	4	27	50	12	XDMW 0806..	4020-M4.5x12	ACK-24	4020-M4.5x12	80-T20	2510-M12x35
AFM42C-XD0806-D080-A27-Z05-H	●	80	5	27	50	12						
AFM42C-XD0806-D100-A32-Z06-H	●	100	6	32	63	12						
AFM42C-XD0806-D125-B40-Z07	●	125	7	40	63	12						
AFM42C-XD0806-D160-C40-Z08	●	160	8	40	63	12						
AFM42C-XD0806-D200-C60-Z09	●	200	9	60	63	12						

DJT Ucuna Uygun. / Compatible with DJT Insert. / Kompatibel mit DJT

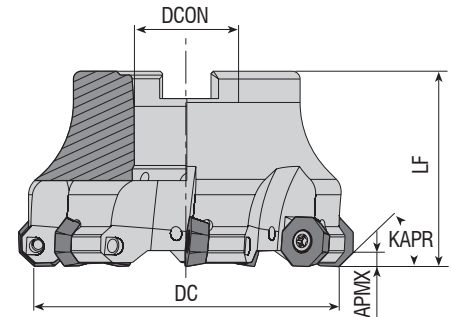

Takım Kodu Ordering Code Bestell-Bezeichnung	Stok Stock Lager	Takım Ölçüleri (mm) Dimension (mm) Abmessung (mm)					Kesici Uç Insert Wendeschneidplatte	Yedek Parçaları / Spare Parts / Ersatzteile			
		DC	ZEPF	DCON	LF	APMX		Sıkma Vidası Screw Schraube	Tork Anahtar Torx Key Torx-Schlüssel	Montaj Vidası Mounting Screw Befestigungsschraube	
AFM43-OD0504-D040-A16-Z04-H	●	40	4	16	40	3.5	OD.. 0504..	4015-M3.5x11	80-T15	2510-M12x35	
AFM43-OD0504-D050-A22-Z05-H	●	50	5	22	40	3.5					
AFM43-OD0504-D063-A22-Z06-H	●	63	6	22	40	3.5					
AFM43-OD0504-D080-A27-Z07-H	●	80	7	27	50	3.5					
AFM43-OD0504-D100-A32-Z08-H	●	100	8	32	50	3.5					

R: Sağ / Right / Rechts L: Sol / Left / Links

● Stokta / In Stock / Auf Lager ○ Stokta Yok / Non Stock Item / Kein Lagerartikel, Lieferzeit auf Anfrage  
WLTR Ucuna Uygun. / Compatible with WLTR Insert. / Kompatibel mit WLTR

Sipariş Örneği/Ordering Example/Bestellbeispiel

1 ad./pcs./stück AFM42C-XD0806-D063-A27-Z04-H

Kesme Hesabı : S 377 / Cutting Calculation : P 377 / Schnittberechnung : P 377

Montaj Ölçüleri : S 374 / Mounting Reference : P 374 / Montagehinweis : P374



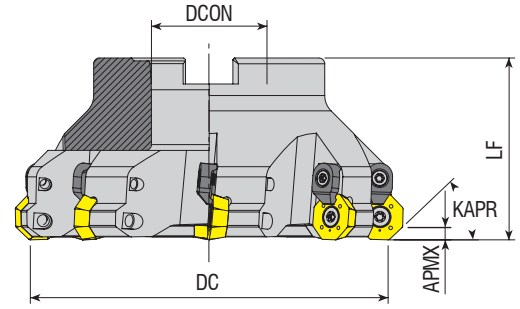
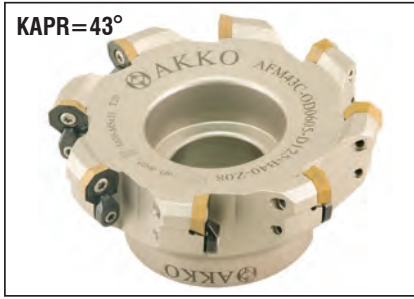

Takım Kodu Ordering Code Bestell-Bezeichnung	Stok Stock Lager	Takım Ölçüleri (mm) Dimension (mm) Abmessung (mm)					Kesici Uç Insert Wendeschneidplatte	Yedek Parçaları / Spare Parts / Ersatzteile				
		DC	ZEFP	DCON	LF	APMX		Sıkma Vidası Screw Schraube	Baskı Parçası Wedge Clamp Spannpratze	Baskı Vidası Clamp Screw Klemmschraube	Tork Anahtar Torx Key Torx-Schlüssel	Montaj Vidası Mounting Screw Befestigungsschraube
AFM43C-OD0605-D080-A27-Z06-H	●	80	6	27	50	4	OD.. 0605..	1020-M5x11	ACK-05	4015-M4x11	80-T20	2510-M12x35
AFM43C-OD0605-D100-A32-Z07-H	●	100	7	32	50	4						2514-M16x35
AFM43C-OD0605-D125-B40-Z08	●	125	8	40	63	4						-

WLTR-LMN Ucuna Uygunur. / Compatible with WLTR-LMN Insert./Kompatibel mit WLTR-LMN

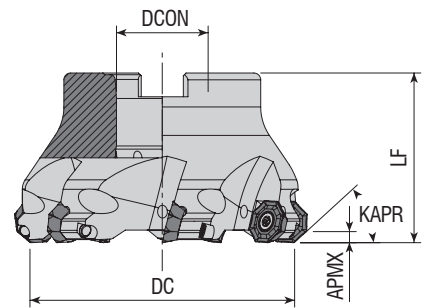

Takım Kodu Ordering Code Bestell-Bezeichnung	Stok Stock Lager	Takım Ölçüleri (mm) Dimension (mm) Abmessung (mm)					Kesici Uç Insert Wendeschneidplatte	Yedek Parçaları / Spare Parts / Ersatzteile			
		DC	ZEFP	DCON	LF	APMX		Sıkma Vidası Screw Schraube	Tork Anahtar Torx Key Torx-Schlüssel	Montaj Vidası Mounting Screw Befestigungsschraube	
AFM43-OF05T3-D050-A22-Z05-H	●	50	5	22	40	3	OF.. 05T3..	4015-M4x9	80-T15	2407-M10x30	
AFM43-OF05T3-D063-A22-Z06-H	●	63	6	22	40	3				2510-M12x35	
AFM43-OF05T3-D080-A27-Z07-H	●	80	7	27	50	3				-	
AFM43-OF05T3-D125-B40-Z09	●	125	9	40	63	3				-	

R: Sağ / Right / Rechts L: Sol / Left / Links

● Stokta / In Stock / Auf Lager ○ Stokta Yok / Non Stock Item / Kein Lagerartikel, Lieferzeit auf Anfrage  
ISO Ucuna Uygunur. / Compatible with ISO Insert. / Kompatibel mit ISO Wendepfatten.

Sipariş Örneği/Ordering Example/Bestellbeispiel

1 ad./pcs./stück AFM43C-OD0605-D080-A27-Z06-H

Kesme Hesabı : S 377 / Cutting Calculation : P 377 / Schnittberechnung : P 377

Montaj Ölçüleri : S 374 / Mounting Reference : P 374 / Montagehinweis : P374

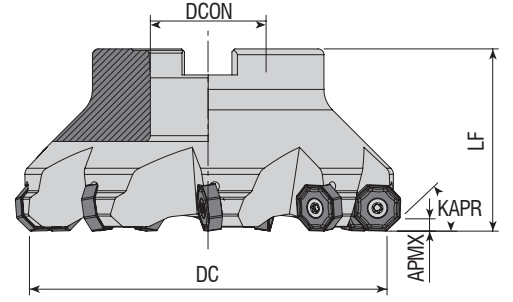

Takım Kodu Ordering Code Bestell-Bezeichnung	Stok Stock Lager	Takım Ölçüleri (mm) Dimension (mm) Abmessung (mm)					Kesici Uç Insert Wendeschneidplatte	Yedek Parçaları / Spare Parts / Ersatzteile		
		DC	ZEFP	DCON	LF	APMX		Sıkma Vidası Screw Schraube	Tork Anahtar Torx Key Torx-Schlüssel	Montaj Vidası Mounting Screw Befestigungsschraube
AFM43-ON0604-D050-A22-Z05-H	●	50	5	22	40	4	ON.. 0604..	4015-M4x11	80-T15	2407-M10x30 2510-M12x35 2514-M16x35 -
AFM43-ON0604-D063-A22-Z06-H	●	63	6	22	40	4				
AFM43-ON0604-D080-A27-Z07-H	●	80	7	27	50	4				
AFM43-ON0604-D100-A32-Z08-H	●	100	8	32	50	4				
AFM43-ON0604-D125-B40-Z09	●	125	9	40	63	4				

ZCC Ucuna Uygundur. / Compatible with ZCC Insert. / Kompatibel mit ZCC Wendeplatten.

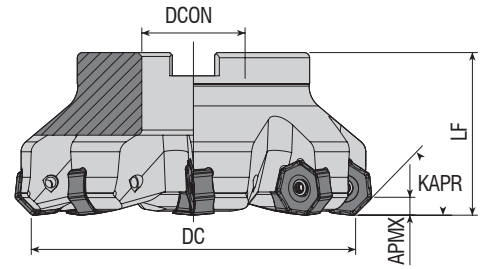
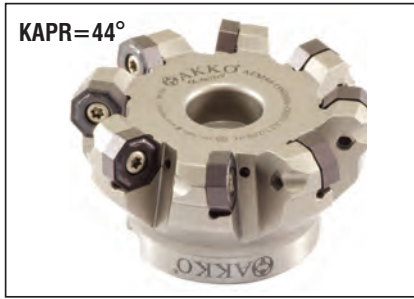

Takım Kodu Ordering Code Bestell-Bezeichnung	Stok Stock Lager	Takım Ölçüleri (mm) Dimension (mm) Abmessung (mm)					Kesici Uç Insert Wendeschneidplatte	Yedek Parçaları / Spare Parts / Ersatzteile		
		DC	ZEFP	DCON	LF	APMX		Sıkma Vidası Screw Schraube	Tork Anahtar Torx Key Torx-Schlüssel	Montaj Vidası Mounting Screw Befestigungsschraube
AFM44-ON0606-D063-A22-Z06-H	●	63	6	22	40	3.8	ONHX 0606..	4020-M4.5x12	80-T20	2407-M10x30 2510-M12x35 2514-M16x35
AFM44-ON0606-D080-A27-Z08-H	●	80	8	27	50	3.8				
AFM44-ON0606-D100-A32-Z10-H	●	100	10	32	50	3.8				

R: Sağ / Right / Rechts L: Sol / Left / Links

● Stokta / In Stock / Auf Lager ○ Stokta Yok / Non Stock Item / Kein Lagerartikel, Lieferzeit auf Anfrage

KRLY Ucuna Uygundur. / Compatible with KRLY Insert./Kompatibel mit KRYL Wendeplatten.

Sipariş Örneği/Ordering Example/Bestellbeispiel

1 ad./pcs./stück AFM43-ON0604-D050-A22-Z05-H

Kesme Hesabı : S 377 / Cutting Calculation : P 377 / Schnittberechnung : P 377

Montaj Ölçüleri : S 374/ Mounting Reference : P 374 / Montagehinweis : P 374

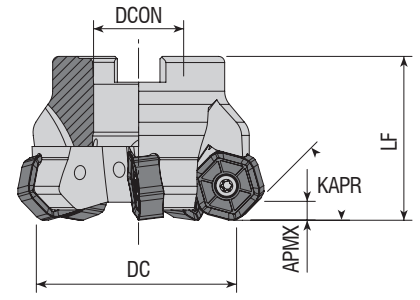

Takım Kodu Ordering Code Bestell-Bezeichnung	Stok Stock Lager	Takım Ölçüleri (mm) Dimension (mm) Abmessung (mm)					Kesici Uç Insert Wendeschneidplatte	Yedek Parçaları / Spare Parts / Ersatzteile			
		DC	ZEFP	DCON	LF	APMX		Sıkma Vidası Screw Schraube	Tork Anahtar Torx Key Torx-Schlüssel	Montaj Vidası Mounting Screw Befestigungsschraube	
AFM45-HN0905-D050-A22-Z05-H	●	50	5	22	40	4.5	HN.. 0905..	4015-M4x11	80-T15	2407-M10x30	
AFM45-HN0905-D063-A22-Z06-H	●	63	6	22	40	4.5					
AFM45-HN0905-D080-A27-Z07-H	●	80	7	27	50	4.5					
AFM45L-HN0905-D100-A32-Z08-H	●	100	8	32	50	4.5					
AFM45-HN0905-D125-B40-Z10	●	125	10	40	63	4.5					
AFM45L-HN0905-D125-B40-Z10	●	125	10	40	63	4.5					
AFM45-HN0905-D160-C40-Z12	●	160	12	40	63	4.5					
AFM45L-HN0905-D160-C40-Z12	●	160	12	40	63	4.5					
AFM45-HN0905-D200-C60-Z16	●	200	16	60	63	4.5					
AFM45L-HN0905-D200-C60-Z16	●	200	16	60	63	4.5					

WDA Ucuna Uygun. / Compatible with WDA Insert. / Kompatibel mit WDA Wendeplatten.

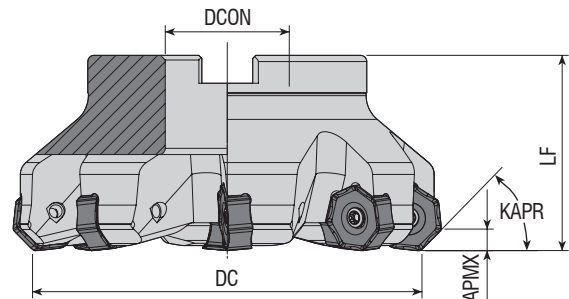

Takım Kodu Ordering Code Bestell-Bezeichnung	Stok Stock Lager	Takım Ölçüleri (mm) Dimension (mm) Abmessung (mm)					Kesici Uç Insert Wendeschneidplatte	Yedek Parçaları / Spare Parts / Ersatzteile			
		DC	ZEFP	DCON	LF	APMX		Sıkma Vidası Screw Schraube	Tork Anahtar Torx Key Torx-Schlüssel	Montaj Vidası Mounting Screw Befestigungsschraube	
AFM40-NN2007-D080-A27-Z06-H	●	80	6	27	50	6	NNMU 2007..	1020-M5x14	80-T20	2514-M16x35	
AFM40-NN2007-D100-B32-Z07-H	●	100	7	32	50	6					
AFM40-NN2007-D125-B40-Z08-H	●	125	8	40	63	6					
AFM40-NN2007-D160-C40-Z10	●	160	10	40	63	6					
AFM40-NN2007-D200-C60-Z12	●	200	12	60	63	6					

R: Sağ / Right / Rechts L: Sol / Left / Links

● Stokta / In Stock / Auf Lager ○ Stokta Yok / Non Stock Item / Kein Lagerartikel, Lieferzeit auf Anfrage  
MTSBH Ucuna Uygun. / Compatible with MTSBH Insert. / Kompatibel mit MTSBH Wendeplatten.

Sipariş Örneği/Ordering Example/Bestellbeispiel

1 ad./pcs./stück AFM45-HN0905-D050-A22-Z05-H

Kesme Hesabı : S 377 / Cutting Calculation : P 377 / Schnittberechnung : P 377

Montaj Ölçüleri : S 374 / Mounting Reference : P 374 / Montagehinweis : P 374

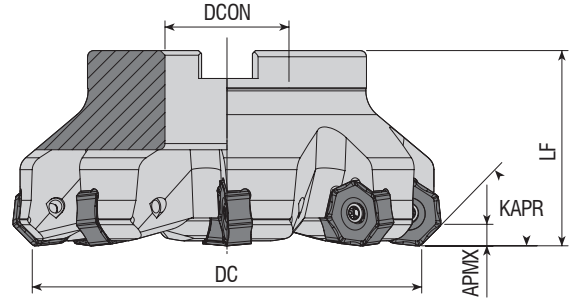

Takım Kodu Ordering Code Bestell-Bezeichnung	Stok Stock Lager	Takım Ölçüleri (mm) Dimension (mm) Abmessung (mm)					Kesici Uç Insert Wendeschneidplatte	Yedek Parçaları / Spare Parts / Ersatzteile		
		DC	ZEP	DCON	LF	APMX		Sıkma Vidası Screw Schraube	Tork Anahtar Torx Key Torx-Schlüssel	Montaj Vidası Mounting Screw Befestigungsschraube
• new AFM45-NN2007-D063-A22-Z05-H	●	63	5	22	50	6	NNMU 2007..	1020-M5x14	80-T20	2508-M10x30
• new AFM45-NN2007-D080-A27-Z06-H	●	80	6	27	50	6				2510-M12x35
AFM45-NN2007-D100-A32-Z07-H	●	100	7	32	50	6				2514-M16x35
AFM45-NN2007-D125-B40-Z08	●	125	8	40	63	6				
AFM45-NN2007-D160-C40-Z10	●	160	10	40	63	6				

R: Sağ / Right / Rechts L: Sol / Left / Links

● Stokta / In Stock / Auf Lager ○ Stokta Yok / Non Stock Item / Kein Lagerartikel, Lieferzeit auf Anfrage  
MTSBH Ucuna Uygunudur. / Compatible with MTSBH Insert. / Kompatibel mit MTSBH Wendeplatten.

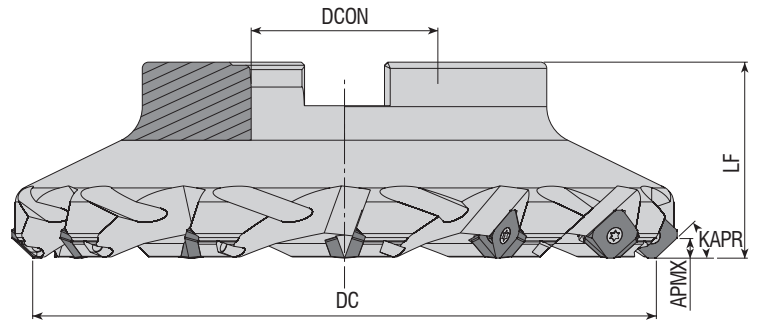

Takım Kodu Ordering Code Bestell-Bezeichnung	Stok Stock Lager	Takım Ölçüleri (mm) Dimension (mm) Abmessung (mm)					Kesici Uç Insert Wendeschneidplatte	Yedek Parçaları / Spare Parts / Ersatzteile		
		DC	ZEP	DCON	LF	APMX		Sıkma Vidası Screw Schraube	Tork Anahtar Torx Key Torx-Schlüssel	Montaj Vidası Mounting Screw Befestigungsschraube
AFM45-SE12-D050-A22-Z04-H	●	50	4	22	40	6	SE.. 12T3.. R245-12T3..	4015-M3.5x11	80-T15	2407-M10x30
AFM45L-SE12-D050-A22-Z04-H	●	50	4	22	40	6				2510-M12x35
AFM45-SE12-D063-A22-Z05-H	●	63	5	22	40	6				2514-M16x35
AFM45L-SE12-D063-A22-Z05-H	●	63	5	22	40	6				
AFM45-SE12-D080-A27-Z06-H	●	80	6	27	50	6				
AFM45L-SE12-D080-A27-Z06-H	●	80	6	27	50	6				
AFM45-SE12-D100-A32-Z07-H	●	100	7	32	50	6				
AFM45-SE12-D125-B40-Z08	●	125	8	40	63	6				
AFM45-SE12-D160-C40-Z10	●	160	10	40	63	6				
AFM45L-SE12-D160-C40-Z10	●	160	10	40	63	6				
AFM45-SE12-D200-C60-Z12	●	200	12	60	63	6				

ZCC-SNDVK Ucuna Uygunudur. / Compatible with ZCC-SNDVK Insert. / Kompatibel mit ZCC-SNDVK Wendeplatten.

Sipariş Örneği/Ordering Example/Bestellbeispiel

1 ad./pcs./stück AFM45-NN2007-D063-A22-Z05-H

Kesme Hesabı : S 377 / Cutting Calculation : P 377 / Schnittberechnung : P 377

Montaj Ölçüleri : S 374 / Mounting Reference : P 374 / Montagehinweis : P374

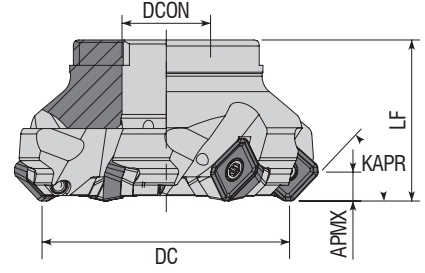

Takım Kodu Ordering Code Bestell-Bezeichnung	Stok Stock Lager	Takım Ölçüleri (mm) Dimension (mm) Abmessung (mm)					Kesici Uç Insert Wendeschneidplatte	Yedek Parçaları / Spare Parts / Ersatzteile				
		DC	ZEPF	DCON	LF	APMX		Altlık Screw Unterlage	Altlık Vidası Wedge Clamp Винт опорной пластины	Sıkma Vidası Screw Schraube	Tork Anahtar Torx Key Torx-Schlüssel	Montaj Vidası Mounting Screw Befestigungsschraube
AFM45-SE13-D050-A22-Z04-H	●	50	4	22	40	6	SEMT 13T3..	AASE-3-0001	AAV-16-M3.5x8	4015-M3.5x11	80-T15	2407-M10x30
AFM45-SE13-D063-A22-Z05-H	●	63	5	22	40	6						
AFM45-SE13-D080-A27-Z06-H	●	80	6	27	50	6						
AFM45S-SE13-D050-A22-Z05-H	●	50	5	22	40	6						
AFM45S-SE13-D063-A22-Z06-H	●	63	6	22	40	6						
AFM45S-SE13-D080-A27-Z08-H	●	80	8	27	50	6						
AFM45S-SE13-D100-A32-Z10-H	●	100	10	32	50	6						
AFM45S-SE13-D125-B40-Z12	●	125	12	40	63	6						

R: Sağ / Right / Rechts L: Sol / Left / Links

● Stokta / In Stock / Auf Lager ○ Stokta Yok / Non Stock Item / Kein Lagerartikel, Lieferzeit auf Anfrage

SMTM-DJT Ucuna Uygundur. / Compatible with SMTM-DJT Insert. / Kompatibel mit SMTM-DJT Wendeplatten.

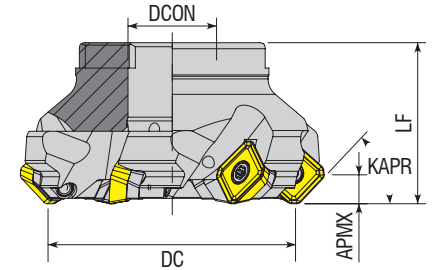

Takım Kodu Ordering Code Bestell-Bezeichnung	Stok Stock Lager	Takım Ölçüleri (mm) Dimension (mm) Abmessung (mm)					Kesici Uç Insert Wendeschneidplatte	Yedek Parçaları / Spare Parts / Ersatzteile		
		DC	ZEPF	DCON	LF	APMX		Sıkma Vidası Screw Schraube	Tork Anahtar Torx Key Torx-Schlüssel	Montaj Vidası Mounting Screw Befestigungsschraube
AFM45-SE13M-D050-A22-Z04-H	●	50	4	22	40	6	SEMT 13T3..	4015-M3.5x11	80-T15	2508-M10x30
AFM45-SE13M-D063-A22-Z05-H	●	63	5	22	40	6				
AFM45-SE13M-D080-A27-Z06	●	80	6	27	50	6				
AFM45-SE13M-D100-A32-Z07	●	100	7	32	50	6				
AFM45-SE13M-D125-B40-Z08	●	125	8	40	63	6				

MTSBH Ucuna Uygundur. / Compatible with MTSBH Insert. / Kompatibel mit MTSBH Wendeplatten.

Sipariş Örneği/Ordering Example/Bestellbeispiel

1 ad./pcs./stück AFM45-SE13-D050-A22-Z04-H

Kesme Hesabı : S 377 / Cutting Calculation : P 377 / Schnittberechnung : P 377

Montaj Ölçüleri : S 374 / Mounting Reference : P 374 / Montagehinweis : P374



KAPR=45°

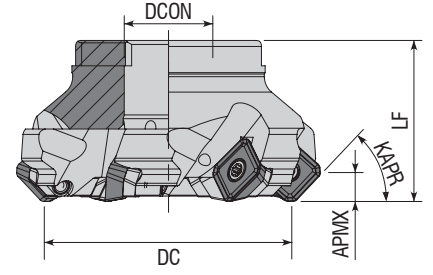

Takım Kodu Ordering Code Bestell-Bezeichnung	Stok Stock Lager	Takım Ölçüleri (mm) Dimension (mm) Abmessung (mm)					Kesici Uç Insert Wendeschneidplatte	Yedek Parçaları / Spare Parts / Ersatzteile					
		DC	ZEFP	DCON	LF	APMX		Altlık Screw Unterlage	Altlık Vidası Wedge Clamp Винт опорной пластины	Sıkma Vidası Screw Schraube	Tork Anahtar Torx Key Torx-Schlüssel	Montaj Vidası Mounting Screw Befestigungsschraube	
AFM45S-SE13M-D050-A22-Z04-H	●	50	4	22	40	6	SEMT 13T3..	AASE-3-0001	AAV-16-M3.5x8	4015-M3.5x12	80-T15	2508-M10x30	
AFM45S-SE13M-D063-A22-Z05-H	●	63	5	22	40	6							2510-M12x35
AFM45S-SE13M-D080-A27-Z06	●	80	6	27	50	6							2514-M16x35
AFM45S-SE13M-D100-A32-Z07	●	100	7	32	50	6							-
AFM45S-SE13M-D125-B40-Z08	●	125	8	40	63	6							-

MTSBH Ucuna Uygun. / Compatible with MTSBH Insert. / Kompatibel mit MTSBH Wendeplatten.

KAPR=45°

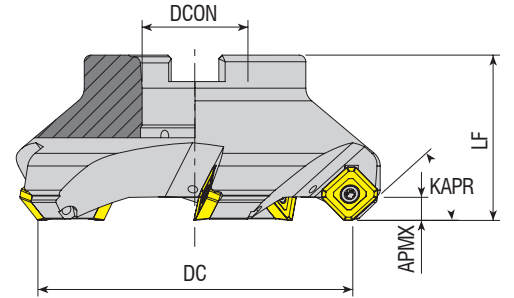

Takım Kodu Ordering Code Bestell-Bezeichnung	Stok Stock Lager	Takım Ölçüleri (mm) Dimension (mm) Abmessung (mm)					Kesici Uç Insert Wendeschneidplatte	Yedek Parçaları / Spare Parts / Ersatzteile		
		DC	ZEFP	DCON	LF	APMX		Sıkma Vidası Screw Schraube	Tork Anahtar Torx Key Torx-Schlüssel	Montaj Vidası Mounting Screw Befestigungsschraube
AFM45-SE14M4-D063-A22-Z04-H	●	63	4	22	40	7	SE.. 14M4..	4015-M3.5x11	80-T15	2407-M10x30
AFM45-SE14M4-D080-A27-Z05-H	●	80	5	27	50	7				2510-M12x35
AFM45-SE14M4-D100-A32-Z05-H	●	100	5	32	50	7				2514-M16x35
AFM45-SE14M4-D125-B40-Z06	●	125	6	40	63	7				-
AFM45-SE14M4-D160-C40-Z07	●	160	7	40	63	7				-

R: Sağ / Right / Rechts L: Sol / Left / Links

● Stokta / In Stock / Auf Lager ○ Stokta Yok / Non Stock Item / Kein Lagerartikel, Lieferzeit auf Anfrage  
KRLY Ucuna Uygun. / Compatible with KRLY Insert. / Kompatibel mit KRYL Wendeplatten.

Sipariş Örneği/Ordering Example/Bestellbeispiel

1 ad./pcs./stück AFM45S-SE13M-D050-A22-Z04-H

Kesme Hesabı : S 377 | Cutting Calculation : P 377 | Schnittberechnung : P 377

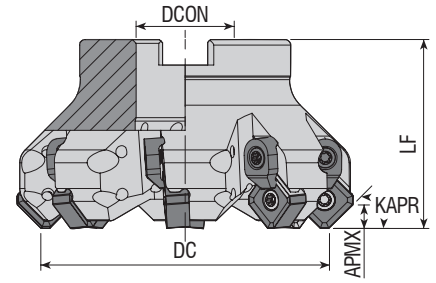

Takım Kodu Ordering Code Bestell-Bezeichnung	Stok Stock Lager	Takım Ölçüleri (mm) Dimension (mm) Abmessung (mm)					Kesici Uç Insert Wendeschneidplatte	Yedek Parçaları / Spare Parts / Ersatzteile				
		DC	ZEFP	DCON	LF	APMX		Sıkma Vidası Screw Schraube	Baskı Parçası Wedge Clamp Spannpratze	Baskı Vidası Clamp Screw Klemmschraube	Tork Anahtar Torx Key Torx-Schlüssel	Montaj Vidası Mounting Screw Befestigungsschraube
AFM45C-SN12..-D050-A22-Z04-H	●	50	4	22	42	6	SN.. 12..	1015-M4x11	ACK-05	4015-M4x11	80-T15	2407-M10x30
AFM45C-SN12..-D050-A22-Z05-H	●	50	5	22	42	6						
AFM45C-SN12..-D063-A22-Z06-H	●	63	6	22	42	6						
AFM45C-SN12..-D063-A22-Z07-H	●	63	7	22	42	6						
AFM45CL-SN12..-D063-A22-Z07-H	●	63	7	22	42	6						
AFM45C-SN12..-D080-A27-Z07-H	●	80	7	27	52	6						
AFM45C-SN12..-D080-A27-Z08-H	●	80	8	27	52	6						
AFM45CL-SN12..-D080-A27-Z08-H	●	80	8	27	52	6						
AFM45C-SN12..-D100-A32-Z08-H	●	100	8	32	52	6						
AFM45C-SN12..-D100-A32-Z10-H	●	100	10	32	52	6						
AFM45CL-SN12..-D100-A32-Z10-H	●	100	10	32	52	6						
AFM45C-SN12..-D125-B40-Z11	●	125	11	40	65	6						
AFM45CL-SN12..-D125-B40-Z11	●	125	11	40	65	6						
AFM45C-SN12..-D160-C40-Z12	●	160	12	40	65	6						
AFM45C-SN12..-D200-C60-Z14	●	200	14	60	65	6						
AFM45CL-SN12..-D200-C60-Z14	●	200	14	60	65	6						

R: Sağ / Right / Rechts L: Sol / Left / Links

● Stokta / In Stock / Auf Lager ○ Stokta Yok / Non Stock Item / Kein Lagerartikel, Lieferzeit auf Anfrage

WLTR-LMN-ACHTK Ucuna Uygunudur. / Compatible with WLTR-LMN-ACHTK Insert. / Kompatibel mit WLTR-LMN-ACHTK Wendeplatten.

Sipariş Örneği/Ordering Example/Bestellbeispiel

1 ad./pcs./stück AFM45C-SN12..-D050-A22-Z04-H

Kesme Hesabı : S 377 / Cutting Calculation : P 377 / Schnittberechnung : P 377



Montaj Ölçüleri : S 374 / Mounting Reference : P 374 / Montagehinweis : P374

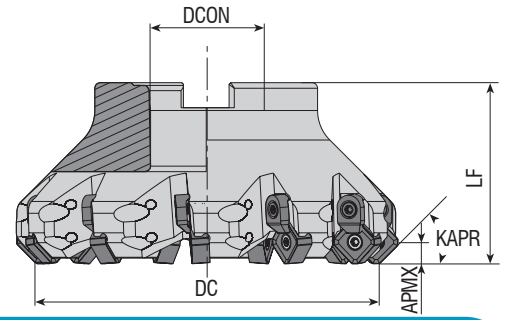

Takım Kodu Ordering Code Bestell-Bezeichnung	Stok Stock Lager	Takım Ölçüleri (mm) Dimension (mm) Abmessung (mm)					Kesici Uç Insert Wendeschneidplatte	Yedek Parçaları / Spare Parts / Ersatzteile					
		DC	ZEFP	DCON	LF	APMX		Sıkma Vidası Screw Schraube	Baskı Parçası Wedge Clamp Spannpratze	Baskı Vidası Clamp Screw Klemmschraube	Tork Anahtar Torx Key Torx-Schlüssel	Montaj Vidası Mounting Screw Befestigungsschraube	
AFM45C-SN1206-D050-A22-Z04-H	●	50	4	22	42	6	SN.. 1206..	4015-M4x11	ACK-05	4015-M4x11	80-T15	2510-M12x35	
AFM45CL-SN1206-D050-A22-Z05-H	●	50	5	22	42	6							
AFM45C-SN1206-D050-A22-Z05-H	●	50	5	22	42	6							
AFM45C-SN1206-D063-A22-Z06-H	●	63	6	22	42	6							2407-M10x30
AFM45C-SN1206-D063-A22-Z07-H	●	63	7	22	42	6							
AFM45CL-SN1206-D063-A22-Z07-H	●	63	7	22	42	6							
AFM45C-SN1206-D080-A27-Z07-H	●	80	7	27	52	6							
AFM45C-SN1206-D080-A27-Z08-H	●	80	8	27	52	6							2510-M12x35
AFM45CL-SN1206-D080-A27-Z08-H	●	80	8	27	52	6							
AFM45C-SN1206-D100-A32-Z08-H	●	100	8	32	52	6							
AFM45C-SN1206-D100-A32-Z10-H	●	100	10	32	52	6							2514-M16x35
AFM45CL-SN1206-D100-A32-Z10-H	●	100	10	32	52	6							
AFM45C-SN1206-D125-B40-Z11	●	125	11	40	65	6							
AFM45CL-SN1206-D125-B40-Z11	●	125	11	40	65	6							
AFM45C-SN1206-D160-C40-Z12	●	160	12	40	65	6							1015-M4x11
AFM45CL-SN1206-D160-C40-Z12	●	160	12	40	65	6							
AFM45C-SN1206-D200-C60-Z14	●	200	14	60	65	6							-
AFM45CL-SN1206-D200-C60-Z14	●	200	14	60	65	6							

KRLY-PLBT-BHLR Ucuna Uygun. / Compatible with KRLY-PLBT-BHLR Insert. / Kompatibel mit KRLY-PLBT-BHLR Wendeplatten.

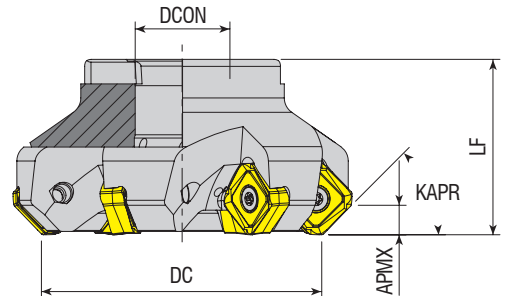

Takım Kodu Ordering Code Bestell-Bezeichnung	Stok Stock Lager	Takım Ölçüleri (mm) Dimension (mm) Abmessung (mm)					Kesici Uç Insert Wendeschneidplatte	Yedek Parçaları / Spare Parts / Ersatzteile		
		DC	ZEFP	DCON	LF	APMX		Sıkma Vidası Screw Schraube	Tork Anahtar Torx Key Torx-Schlüssel	Montaj Vidası Mounting Screw Befestigungsschraube
AFM45-SA1706-D080-A27-Z06-H	●	80	6	27	50	8.4	SAKU 1706..	1020-M5x14	80-T20	2510-M12x35
AFM45-SA1706-D100-A32-Z07-H	●	100	7	32	50	8.4				2514-M16x35
AFM45-SA1706-D125-B40-Z09	●	125	9	40	63	8.4				-

R: Sağ / Right / Rechts L: Sol / Left / Links

● Stokta / In Stock / Auf Lager ○ Stokta Yok / Non Stock Item / Kein Lagerartikel, Lieferzeit auf Anfrage

CRTZT Ucuna Uygun. / Compatible with CRTZT Insert. / Kompatibel mit CRTZT Wendeplatten.

Sipariş Örneği/Ordering Example/Bestellbeispiel

1 ad./pcs./stück AFM45C-SN1206-D050-A22-Z04-H

Kesme Hesabı : S 377 / Cutting Calculation : P 377 / Schnittberechnung : P 377

Montaj Ölçüleri : S 374 / Mounting Reference : P 374 / Montagehinweis : P374



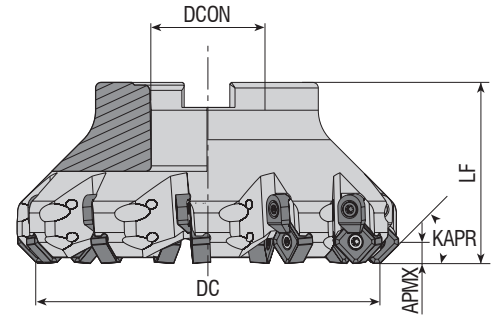

Takım Kodu Ordering Code Bestell-Bezeichnung	Stok Stock Lager	Takım Ölçüleri (mm) Dimension (mm) Abmessung (mm)					Kesici Uç Insert Wendeschneidplatte	Yedek Parçaları / Spare Parts / Ersatzteile								
		DC	ZEFP	DCON	LF	APMX		Sıkma Vidası Screw Schraube	Baskı Parçası Wedge Clamp Spannpratze	Baskı Vidası Clamp Screw Klemmschraube	Tork Anahtar Torx Key Torx-Schlüssel	Montaj Vidası Mounting Screw Befestigungsschraube				
AFM45C-SN12Z-D050-A22-Z05-H	●	50	5	22	42	6	SNEG 1205..			4015-M4x11	ACK-05	4015-M4x11	80-T15			2407-M10X30
AFM45C-SN12Z-D063-A22-Z06-H	●	63	6	22	42	6										2510-M12x35
AFM45C-SN12Z-D080-A27-Z07-H	●	80	7	27	52	6										2514-M16x35
AFM45C-SN12Z-D100-A32-Z09-H	●	100	9	32	52	6										-
AFM45C-SN12Z-D125-B40-Z11	●	125	11	40	65	6										-
AFM45C-SN12Z-D160-C40-Z12	●	160	12	60	65	6										-
AFM45C-SN12Z-D200-C60-Z14	●	200	14	60	65	6										-

ZCC Ucuna Uygundur. / Compatible with ZCC Insert. / Kompatibel mit ZCC Wendeplatten.

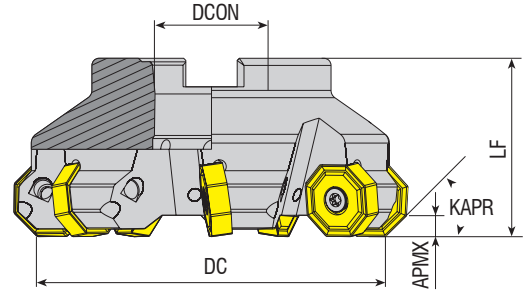

Takım Kodu Ordering Code Bestell-Bezeichnung	Stok Stock Lager	Takım Ölçüleri (mm) Dimension (mm) Abmessung (mm)					Kesici Uç Insert Wendeschneidplatte	Yedek Parçaları / Spare Parts / Ersatzteile						
		DC	ZEFP	DCON	LF	APMX		Sıkma Vidası Screw Schraube	Tork Anahtar Torx Key Torx-Schlüssel	Montaj Vidası Mounting Screw Befestigungsschraube				
new AFM45-ON0806-D050-A22-Z04-H	●	50	4	22	40	5.5	ON.. 0806..			1020-M5x14	80-T20			-
AFM45-ON0806-D063-A22-Z05-H	●	63	5	22	40	5.5								2508-M10x30
AFM45-ON0806-D063-A22-Z06-H	●	63	6	22	40	5.5								2510-M12x35
new AFM45-ON0806-D063-A22-Z07-H	●	63	7	22	40	5.5								2514-M16x35
AFM45-ON0806-D080-A27-Z06-H	●	80	6	27	50	5.5								-
AFM45-ON0806-D080-A27-Z08-H	●	80	8	27	50	5.5								-
AFM45-ON0806-D100-A32-Z07-H	●	100	7	32	50	5.5								-
new AFM45-ON0806-D100-A32-Z10	●	100	10	32	50	5.5								-
AFM45-ON0806-D100-A32-Z10-H	●	100	10	32	50	5.5								-
new AFM45L-ON0806-D100-A32-Z10-H	●	100	10	32	50	5.5								-
AFM45-ON0806-D125-B40-Z08	●	125	8	40	63	5.5								-
new AFM45L-ON0806-D125-B40-Z08	●	125	8	40	63	5.5								-
AFM45-ON0806-D125-B40-Z12	●	125	12	40	63	5.5								-
AFM45-ON0806-D160-C40-Z10	●	160	10	40	63	5.5								-
AFM45-ON0806-D160-C40-Z14	●	160	14	40	63	5.5								-
AFM45-ON0806-D200-C60-Z12	●	200	12	60	63	5.5								-
AFM45-ON0806-D250-C60-Z14	●	250	14	60	63	5.5								-
AFM45-ON0806-D315-D60-Z16	●	315	16	60	63	5.5								-

R: Sağ / Right / Rechts L: Sol / Left / Links

● Stokta / In Stock / Auf Lager ○ Stokta Yok / Non Stock Item / Kein Lagerartikel, Lieferzeit auf Anfrage

ISO Ucuna Uygundur. / Compatible with ISO Insert. / Kompatibel mit ISO Wendeplatten.

Sipariş Örneği/Ordering Example/Bestellbeispiel

1 ad./pcs./stück AFM45C-SN12Z-D050-A22-Z05-H

Kesme Hesabı : S 377 / Cutting Calculation : P 377 / Schnittberechnung : P 377

Montaj Ölçüleri : S 374 / Mounting Reference : P 374 / Montagehinweis : P 374

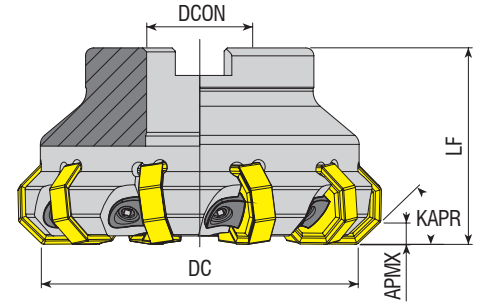

Takım Kodu Ordering Code Bestell-Bezeichnung	Stok Stock Lager	Takım Ölçüleri (mm) Dimension (mm) Abmessung (mm)					Kesici Uç Insert Wendeschneidplatte	Yedek Parçaları / Spare Parts / Ersatzteile				
		DC	ZEFP	DCON	LF	APMX		Baskı Parçası Wedge Clamp Spannpratze	Baskı Vidası Clamp Screw Klemmschraube	Anahtar Allen Key Innensechskantschlüssel	Montaj Vidası Mounting Screw Befestigungsschraube	
<b>new</b> AFM45C-ON0806-D063-A22-Z08	●	63	8	22	50	5.5	ON.. 0806..	ACK-26	AKV-26-M6x0.75x20	AAL-03-3	-	2508-M10x30
AFM45C-ON0806-D080-A27-Z10	●	80	10	27	50	5.5						2510-M12x35
AFM45C-ON0806-D100-A32-Z14	●	100	14	32	50	5.5						2514-M16x35
AFM45C-ON0806-D125-B40-Z18	●	125	18	40	63	5.5						-
AFM45C-ON0806-D160-C40-Z22	●	160	22	40	63	5.5						-

ISO Ucuna Uygundur. / Compatible with ISO Insert. / Kompatibel mit ISO Wendeplatten.

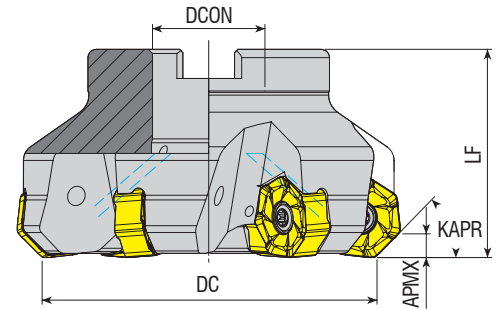

Takım Kodu Ordering Code Bestell-Bezeichnung	Stok Stock Lager	Takım Ölçüleri (mm) Dimension (mm) Abmessung (mm)					Kesici Uç Insert Wendeschneidplatte	Yedek Parçaları / Spare Parts / Ersatzteile				
		DC	ZEFP	DCON	LF	APMX		Sıkma Vidası Screw Schraube	Baskı Parçası Wedge Clamp Spannpratze	Baskı Vidası Clamp Screw Klemmschraube	Tork Anahtar Torx Key Torx-Schlüssel	Montaj Vidası Mounting Screw Befestigungsschraube
AFM45-XN0906-D063-A22-Z06-H	●	63	6	22	50	5	XNMU 0906..	1120-M5x13	-	-	80-T20	2407-M10x30
AFM45-XN0906-D080-A27-Z06-H	●	80	6	27	50	5						2510-M12x35
AFM45-XN0906-D100-A32-Z07-H	●	100	7	32	55	5						2514-M16x35
AFM45-XN0906-D125-B40-Z08	●	125	8	40	63	5						-

R: Sağ / Right / Rechts L: Sol / Left / Links  
● Stokta / In Stock / Auf Lager ○ Stokta Yok / Non Stock Item / Kein Lagerartikel, Lieferzeit auf Anfrage  
TGTC Ucuna Uygundur. / Compatible with TGTC Insert. / Kompatibel mit TGTC Wendeplatten.

Sipariş Örneği/Ordering Example/Bestellbeispiel  
1 ad./pcs./stück AFM45C-ON0806-D063-A22-Z08  
Kesme Hesabı : S 377 / Cutting Calculation : P 377 / Schnittberechnung : P 377  
Montaj Ölçüleri : S 374 / Mounting Reference : P 374 / Montagehinweis : P 374



KAPR=45°

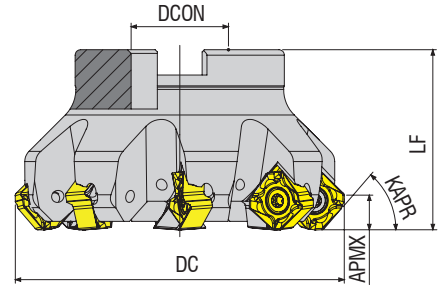
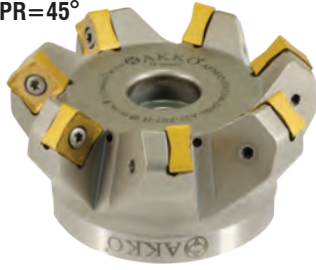

Takım Kodu Ordering Code Bestell-Bezeichnung	Stok Stock Lager	Takım Ölçüleri (mm) Dimension (mm) Abmessung (mm)					Kesici Uç Insert Wendeschneidplatte	Yedek Parçaları / Spare Parts / Ersatzteile			
		DC	ZEFP	DCON	LF	APMX		Sıkma Vidası Screw Schraube	Tork Anahtar Torx Key Torx-Schlüssel	Montaj Vidası Mounting Screw Befestigungsschraube	
AFM45-SN1306-D050-A22-Z05-H	●	50	5	22	40	7	SNGX 1306..				
AFM45-SN1306-D063-A22-Z06-H	●	63	6	22	40	7					2508-M10x30
AFM45-SN1306-D080-A27-Z07-H	●	80	7	27	50	7					2510-M12x35
AFM45-SN1306-D100-A32-Z08-H	●	100	8	32	50	7					2514-M16x35

TGTC Ucuna Uygunudur. / Compatible with TGTC Insert. / Kompatibel mit TGTC Wendeplatten.

KAPR=66°

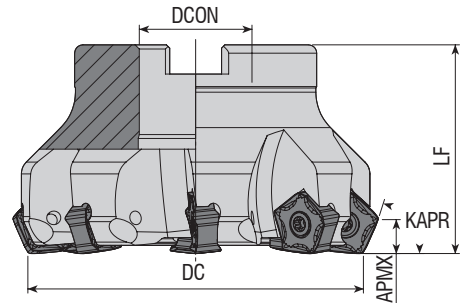

Takım Kodu Ordering Code Bestell-Bezeichnung	Stok Stock Lager	Takım Ölçüleri (mm) Dimension (mm) Abmessung (mm)					Kesici Uç Insert Wendeschneidplatte	Yedek Parçaları / Spare Parts / Ersatzteile			
		DC	ZEFP	DCON	LF	APMX		Sıkma Vidası Screw Schraube	Tork Anahtar Torx Key Torx-Schlüssel	Montaj Vidası Mounting Screw Befestigungsschraube	
AFM66-PN0905-D050-A22-Z05	●	50	5	22	40	8	PNMU 0905..				
AFM66-PN0905-D063-A22-Z06	●	63	6	22	40	8					2508-M10x30
AFM66-PN0905-D080-A27-Z08	●	80	8	27	50	8					2510-M12x35
AFM66-PN0905-D100-A32-Z10	●	100	10	32	50	8					2514-M16x35
AFM66-PN0905-D125-B40-Z12	●	125	12	40	63	8					-

R: Sağ / Right / Rechts L: Sol / Left / Links

● Stokta / In Stock / Auf Lager ○ Stokta Yok / Non Stock Item / Kein Lagerartikel, Lieferzeit auf Anfrage  
KYCR Ucuna Uygunudur. / Compatible with KYCR Insert. / Kompatibel mit KYCR Wendeplatten.

Sipariş Örneği/Ordering Example/Bestellbeispiel

1 ad./pcs./stück AFM45-SN1306-D050-A22-Z05-H

Kesme Hesabı : S 377 / Cutting Calculation : P 377 / Schnittberechnung : P 377

Montaj Ölçüleri : S 374/ Mounting Reference : P 374 / Montagehinweis : P374

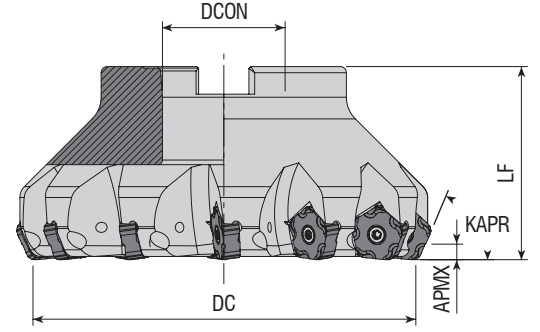

Takım Kodu Ordering Code Bestell-Bezeichnung	Stok Stock Lager	Takım Ölçüleri (mm) Dimension (mm) Abmessung (mm)					Kesici Uç Insert Wendeschneidplatte	Yedek Parçaları / Spare Parts / Ersatzteile		
		DC	ZEFP	DCON	LF	APMX		Sıkma Vidası Screw Schraube	Tork Anahtar Torx Key Torx-Schlüssel	Montaj Vidası Mounting Screw Befestigungsschraube
AFM67-PN1105-D050-A22-Z05	●	50	5	22	50	5	PNEG 1105..	4015-M4x11	80-T15	2508-M10x30
AFM67-PN1105-D063-A22-Z06	●	63	6	22	50	5				
AFM67-PN1105-D080-A27-Z08	●	80	8	27	50	5				
AFM67-PN1105-D100-B32-Z10	●	100	10	32	50	5				
AFM67-PN1105-D125-B40-Z12	●	125	12	40	63	5				
AFM67-PN1105-D160-C40-Z14	●	160	14	40	63	5				-

ZCC Ucuna Uygunur. / Compatible with ZCC Insert. / Kompatibel mit ZCC Wendeplatten.

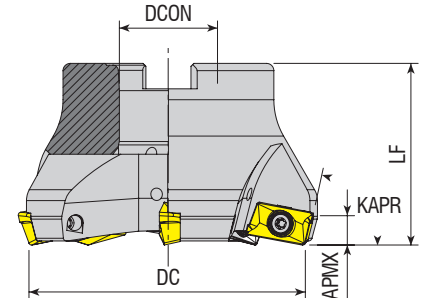

Takım Kodu Ordering Code Bestell-Bezeichnung	Stok Stock Lager	Takım Ölçüleri (mm) Dimension (mm) Abmessung (mm)					Kesici Uç Insert Wendeschneidplatte	Yedek Parçaları / Spare Parts / Ersatzteile		
		DC	ZEFP	DCON	LF	APMX		Sıkma Vidası Screw Schraube	Tork Anahtar Torx Key Torx-Schlüssel	Montaj Vidası Mounting Screw Befestigungsschraube
AFM75-AP16-D063-A22-Z04-H	●	63	4	22	40	6	AP. 1604..	4015-M4x11	80-T15	2508-M10x30
AFM75-AP16-D080-A27-Z05-H	●	80	5	27	50	6				2510-M12x35
AFM75-AP16-D100-A32-Z06-H	●	100	6	32	50	6				2514-M16x35
AFM75-AP16-D125-B40-Z07	●	125	7	40	63	6				-

ISO Ucuna Uygunur. / Compatible with ISO Insert. / Kompatibel mit ISO Wendeplatten.

R: Sağ / Right / Rechts L: Sol / Left / Links

● Stokta / In Stock / Auf Lager ○ Stokta Yok / Non Stock Item / Kein Lagerartikel, Lieferzeit auf Anfrage

Sipariş Örneği/Ordering Example/Bestellbeispiel

1 ad./pcs./stück AFM67-PN1105-D050-A22-Z05

Kesme Hesabı : S 377 / Cutting Calculation : P 377 / Schnittberechnung : P 377

Montaj Ölçüleri : S 374 / Mounting Reference : P 374 / Montagehinweis : P374

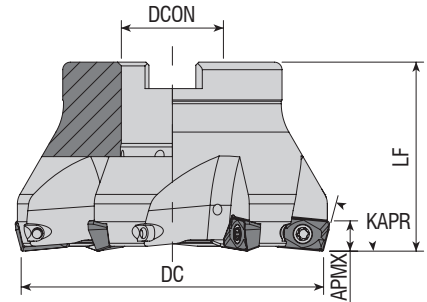

Takım Kodu Ordering Code Bestell-Bezeichnung	Stok Stock Lager	Takım Ölçüleri (mm) Dimension (mm) Abmessung (mm)					Kesici Uç Insert Wendeschneidplatte	Yedek Parçaları / Spare Parts / Ersatzteile		
		DC	ZEPF	DCON	LF	APMX		Sıkma Vidası Screw Schraube	Tork Anahtar Torx Key Torx-Schlüssel	Montaj Vidası Mounting Screw Befestigungsschraube
AFM75-XO12-D050-A22-Z04-H	●	50	4	22	40	-	XO.. 1204..	3010-M3.5x9	82-T10	2508-M10x30
AFM75-XO12-D063-A22-Z05-H	●	63	5	22	40	-				
AFM75-XO12-D080-A27-Z06-H	●	80	6	27	50	-				2510-M12x35

SC Ucuna Uygun. / Compatible with SC Insert. / Kompatibel mit SC Wendeplatten.

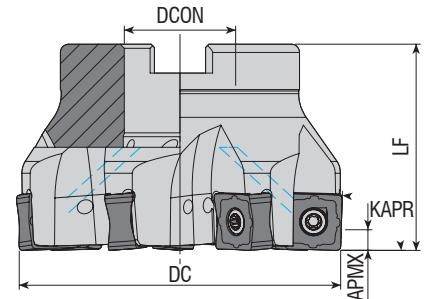

Takım Kodu Ordering Code Bestell-Bezeichnung	Stok Stock Lager	Takım Ölçüleri (mm) Dimension (mm) Abmessung (mm)					Kesici Uç Insert Wendeschneidplatte	Yedek Parçaları / Spare Parts / Ersatzteile		
		DC	ZEPF	DCON	LF	APMX		Sıkma Vidası Screw Schraube	Tork Anahtar Torx Key Torx-Schlüssel	Montaj Vidası Mounting Screw Befestigungsschraube
AFM88-SN1305-D050-A22-Z04	●	50	4	22	40	5	SNMU 1305..	4015-M4x11	80-T15	2508-M10x30
AFM88-SN1305-D050-A22-Z05	●	50	5	22	40	5				
AFM88-SN1305-D063-A22-Z05	●	63	5	22	40	5				
new AFM88L-SN1305-D063-A22-Z07	●	63	7	22	40	5				
AFM88-SN1305-D063-A22-Z07	●	63	7	22	40	5				
AFM88-SN1305-D080-A27-Z06	●	80	6	27	50	5				
AFM88-SN1305-D080-A27-Z09	●	80	9	27	50	5				
AFM88-SN1305-D100-A32-Z07	●	100	7	32	50	5				
AFM88-SN1305-D100-A32-Z11	●	100	11	32	50	5				
AFM88-SN1305-D125-B40-Z13	●	125	13	40	63	5				-

R: Sağ / Right / Rechts L: Sol / Left / Links

● Stokta / In Stock / Auf Lager ○ Stokta Yok / Non Stock Item / Kein Lagerartikel, Lieferzeit auf Anfrage  
KYCR Ucuna Uygun. / Compatible with KYCR Insert. / Kompatibel mit KYCR Wendeplatten.

Sipariş Örneği/Ordering Example/Bestellbeispiel

1 ad./pcs./stück AFM75-XO12-D050-A22-Z04-H

Kesme Hesabı : S 377 / Cutting Calculation : P 377 / Schnittberechnung : P 377

Montaj Ölçüleri : S 374 / Mounting Reference : P 374 / Montagehinweis : P 374

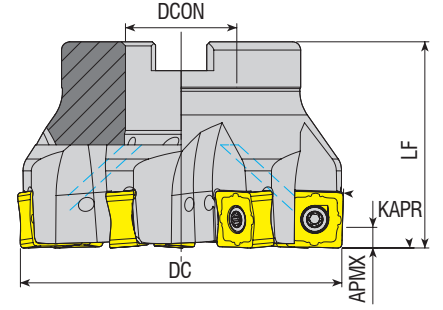

Takım Kodu Ordering Code Bestell-Bezeichnung	Stok Stock Lager	Takım Ölçüleri (mm) Dimension (mm) Abmessung (mm)					Kesici Uç Insert Wendeschneidplatte	Yedek Parçaları / Spare Parts / Ersatzteile					
		DC	ZEFP	DCON	LF	APMX		Sıkma Vidası Screw Schraube	Tork Anahtar Torx Key Torx-Schlüssel	Montaj Vidası Mounting Screw Befestigungsschraube			
AFM88-SN1306-D050-A22-Z05-H	●	50	5	22	40	12	SNGX 1306..						
AFM88-SN1306-D063-A22-Z06-H	●	63	6	22	40	12					1115-M4x10	80-T15	2508-M10x30
AFM88-SN1306-D080-A27-Z07-H	●	80	7	27	50	12							2510-M12x35

TGTC Ucuna Uygundur. / Compatible with TGTC Insert. / Kompatibel mit TGTC Wendeplatten.

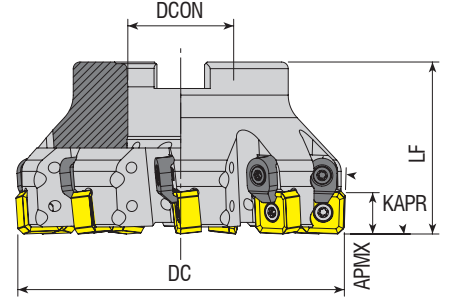
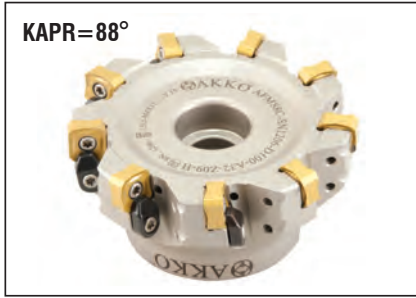

Takım Kodu Ordering Code Bestell-Bezeichnung	Stok Stock Lager	Takım Ölçüleri (mm) Dimension (mm) Abmessung (mm)					Kesici Uç Insert Wendeschneidplatte	Yedek Parçaları / Spare Parts / Ersatzteile									
		DC	ZEFP	DCON	LF	APMX		Sıkma Vidası Screw Schraube	Baskı Parçası Wedge Clamp Spannpratze	Baskı Vidası Clamp Screw Klemmschraube	Tork Anahtar Torx Key Torx-Schlüssel	Montaj Vidası Mounting Screw Befestigungsschraube					
<b>new</b> AFM88C-SN1206-D040-A16-Z04-H	●	40	4	16	40	11.5	SN.. 1206..										
AFM88C-SN1206-D050-A22-Z05-H	●	50	5	22	40	11.5							4015-M4x11	2506-M8x30			
AFM88C-SN1206-D063-A22-Z06-H	●	63	6	22	40	11.5							4615-M4x11	2508-M10x30			
AFM88C-SN1206-D080-A27-Z07-H	●	80	7	27	50	11.5							4615-M4x11	ACK-05	4015-M4x11	80-T15	2510-M12x35
AFM88C-SN1206-D100-A32-Z09-H	●	100	9	32	52	11.5											2514-M16x35
<b>new</b> AFM88C-SN1206-D125-B40-Z10	●	125	10	40	63	11.5							1015-M4x11				

R: Sağ / Right / Rechts L: Sol / Left / Links

● Stokta / In Stock / Auf Lager ○ Stokta Yok / Non Stock Item / Kein Lagerartikel, Lieferzeit auf Anfrage

KRLY Ucuna Uygundur. / Compatible with KRLY Insert. / Kompatibel mit KRLY Wendeplatten.

Sipariş Örneği/Ordering Example/Bestellbeispiel

1 ad./pcs./stück AFM88-SN1306-D050-A22-Z05-H

Kesme Hesabı : S 377 / Cutting Calculation : P 377 / Schnittberechnung : P 377

Montaj Ölçüleri : S 374 / Mounting Reference : P 374 / Montagehinweis : P374

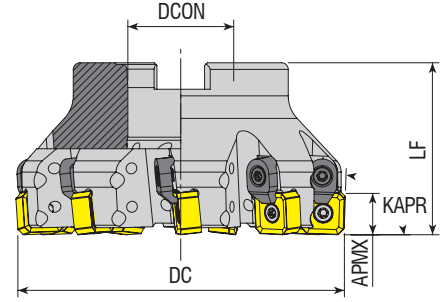

Takım Kodu Ordering Code Bestell-Bezeichnung	Stok Stock Lager	Takım Ölçüleri (mm) Dimension (mm) Abmessung (mm)					Kesici Uç Insert Wendeschneidplatte	Yedek Parçaları / Spare Parts / Ersatzteile				
		DC	ZEFP	DCON	LF	APMX		Sıkma Vidası Screw Schraube	Baskı Parçası Wedge Clamp Spannpratze	Baskı Vidası Clamp Screw Klemmschraube	Tork Anahtar Torx Key Torx-Schlüssel	Montaj Vidası Mounting Screw Befestigungsschraube
AFM88C-SN12..-D050-A22-Z05-H	●	50	5	22	40	11.5	SN.. 12..	1015-M4x11	ACK-05	4015-M4x11	80-T15	2508-M10x30 2510-M12x35 2514-M16x35
AFM88C-SN12..-D063-A22-Z06-H	●	63	6	22	40	11.5						
AFM88C-SN12..-D080-A27-Z07-H	●	80	7	27	50	11.5						
AFM88C-SN12..-D100-A32-Z09-H	●	100	9	32	52	11.5						

ISO Ucuna Uygundur. / Compatible with ISO Insert. / Kompatibel mit ISO Wendepplatten.

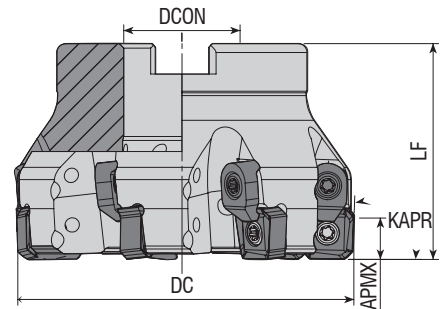

Takım Kodu Ordering Code Bestell-Bezeichnung	Stok Stock Lager	Takım Ölçüleri (mm) Dimension (mm) Abmessung (mm)					Kesici Uç Insert Wendeschneidplatte	Yedek Parçaları / Spare Parts / Ersatzteile				
		DC	ZEFP	DCON	LF	APMX		Sıkma Vidası Screw Schraube	Baskı Parçası Wedge Clamp Spannpratze	Baskı Vidası Clamp Screw Klemmschraube	Tork Anahtar Torx Key Torx-Schlüssel	Montaj Vidası Mounting Screw Befestigungsschraube
AFM88C-SN12Z-D063-A22-Z06-H	●	63	6	22	40	11.5	SNEG 1205..	4015-M4x11	ACK-05	4015-M4x11	80-T15	2508-M10x30 2510-M12x35
AFM88C-SN12Z-D080-A27-Z07-H	●	80	7	27	50	11.5						

R: Sağ / Right / Rechts L: Sol / Left / Links

● Stokta / In Stock / Auf Lager ○ Stokta Yok / Non Stock Item / Kein Lagerartikel, Lieferzeit auf Anfrage

ZCC Ucuna Uygundur. / Compatible with ZCC Insert. / Kompatibel mit ZCC Wendepplatten.

Sipariş Örneği/Ordering Example/Bestellbeispiel

1 ad./pcs./stück AFM88C-SN12..-D050-A22-Z05-H

Kesme Hesabı : S 377 / Cutting Calculation : P 377 / Schnittberechnung : P 377

Montaj Ölçüleri : S 374 / Mounting Reference : P 374 / Montagehinweis : P374

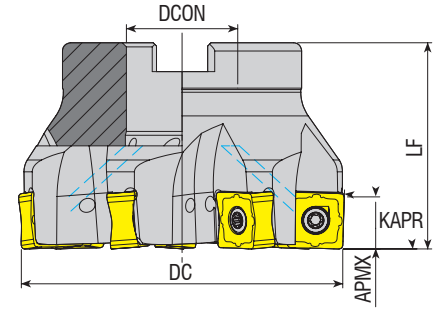

Takım Kodu Ordering Code Bestell-Bezeichnung	Stok Stock Lager	Takım Ölçüleri (mm) Dimension (mm) Abmessung (mm)					Kesici Uç Insert Wendeschneidplatte	Yedek Parçaları / Spare Parts / Ersatzteile				
		DC	ZEFP	DCON	LF	APMX		Sıkma Vidası Screw Schraube	Baskı Parçası Wedge Clamp Spannpratze	Baskı Vidası Clamp Screw Klemmschraube	Tork Anahtar Torx Key Torx-Schlüssel	Montaj Vidası Mounting Screw Befestigungsschraube
AFM89-SN1305I-D040-A16-Z04-H	●	40	4	16	40	10	SNMU 1305..	1015 M4x11	-	-	80-T15	2306-M8x37
AFM89-SN1305I-D050-A22-Z05-H	●	50	5	22	40	10						
AFM89-SN1305I-D063-A22-Z06-H	●	63	6	22	40	10	SNMU 1305..					
AFM89-SN1305I-D063-A22-Z07-H	●	63	7	22	40	10						
AFM89-SN1305I-D080-A27-Z08-H	●	80	8	27	50	10	OXMT 0507..					
AFM89-SN1305I-D100-A32-Z10-H	●	100	10	32	50	10						

ISCR Ucuna Uygundur. / Compatible with ISCR Insert. / Kompatibel mit ISCR Wendepalten.

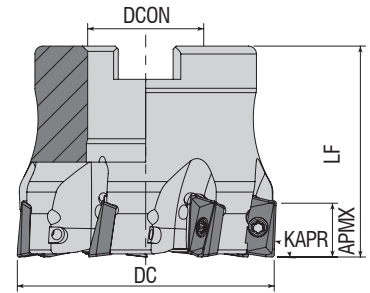

Takım Kodu Ordering Code Bestell-Bezeichnung	Stok Stock Lager	Takım Ölçüleri (mm) Dimension (mm) Abmessung (mm)					Kesici Uç Insert Wendeschneidplatte	Yedek Parçaları / Spare Parts / Ersatzteile		
		DC	ZEFP	DCON	LF	APMX		Sıkma Vidası Screw Schraube	Tork Anahtar Torx Key Torx-Schlüssel	Montaj Vidası Mounting Screw Befestigungsschraube
AFM90-AD10T3-D040-A16-Z06-H	●	40	6	16	40	10	ADMT 10T3..	3008-M2.5x6	82-T08	2506-M8x30
AFM90-AD10T3-D050-A22-Z07-H	●	50	7	22	40	10				2508-M10x30

R: Sağ / Right / Rechts L: Sol / Left / Links

● Stokta / In Stock / Auf Lager ○ Stokta Yok / Non Stock Item / Kein Lagerartikel, Lieferzeit auf Anfrage  
WLTR Ucuna Uygundur. / Compatible with WLTR Insert. / Kompatibel mit WLTR Wendepalten.



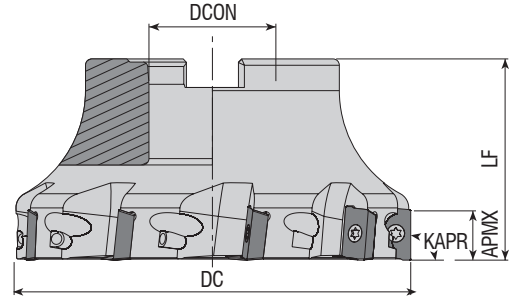

Takım Kodu Ordering Code Bestell-Bezeichnung	Stok Stock Lager	Takım Ölçüleri (mm) Dimension (mm) Abmessung (mm)					Kesici Uç Insert Wendeschneidplatte	Yedek Parçaları / Spare Parts / Ersatzteile		
		DC	ZEFP	DCON	LF	APMX		Sıkma Vidası Screw Schraube	Tork Anahtar Torx Key Torx-Schlüssel	Montaj Vidası Mounting Screw Befestigungsschraube
AFM90-AD1505-D040-A16-Z04-H	●	40	4	16	40	14.3	AD.. 1505..	4015-M4x11	80-T15	2506-M8x30
AFM90-AD1505-D050-A22-Z05-H	●	50	5	22	40	14.3				2508-M10x30
AFM90-AD1505-D063-A22-Z06-H	●	63	6	22	40	14.3				2510-M12x35
AFM90-AD1505-D080-A27-Z07-H	●	80	7	27	50	14.3				2514-M16x35
AFM90-AD1505-D100-A32-Z08-H	●	100	8	32	50	14.3				-
AFM90-AD1505-D125-B40-Z09	●	125	9	40	63	14.3				-

ISCR Ucuna Uygunur. / Compatible with ISCR Insert. / Kompatibel mit ISCR Wendeplatten.

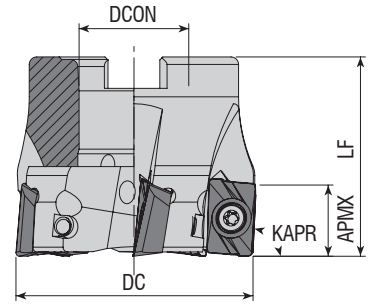

Takım Kodu Ordering Code Bestell-Bezeichnung	Stok Stock Lager	Takım Ölçüleri (mm) Dimension (mm) Abmessung (mm)					Kesici Uç Insert Wendeschneidplatte	Yedek Parçaları / Spare Parts / Ersatzteile		
		DC	ZEFP	DCON	LF	APMX		Sıkma Vidası Screw Schraube	Tork Anahtar Torx Key Torx-Schlüssel	Montaj Vidası Mounting Screw Befestigungsschraube
AFM90-AD1505D-D050-A22-Z05-H	●	50	5	22	40	14.3	ADKT 150508	4015-M4x11	80-T15	2508-M10x30
AFM90-AD1505D-D063-A27-Z06-H	●	63	6	27	50	14.3				2510-M12x35
AFM90-AD1505D-D080-A27-Z08-H	●	80	8	27	50	14.3				2514-M16x35
AFM90-AD1505D-D100-A32-Z08-H	●	100	8	32	50	14.3				-
AFM90-AD1505D-D125-B40-Z09	●	125	9	40	63	14.3				-

R: Sağ / Right / Rechts L: Sol / Left / Links

● Stokta / In Stock / Auf Lager ○ Stokta Yok / Non Stock Item / Kein Lagerartikel, Lieferzeit auf Anfrage  
DJT Ucuna Uygunur. / Compatible with DJT Insert. / Kompatibel mit DJT Wendeplatten.

Sipariş Örneği/Ordering Example/Bestellbeispiel

1 ad./pcs./stück AFM90-AD1505-D040-A16-Z04-H

Kesme Hesabı : S 377 / Cutting Calculation : P 377 / Schnittberechnung : P 377

Montaj Ölçüleri : S 374 / Mounting Reference : P 374 / Montagehinweis : P374

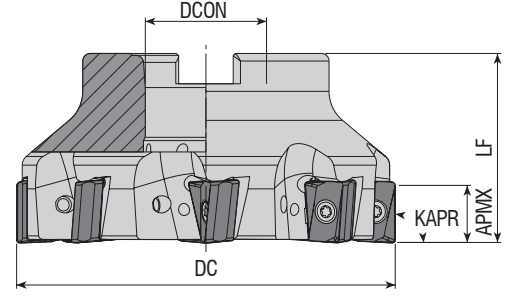

Takım Kodu Ordering Code Bestell-Bezeichnung	Stok Stock Lager	Takım Ölçüleri (mm) Dimension (mm) Abmessung (mm)					Kesici Uç Insert Wendeschneidplatte	Yedek Parçaları / Spare Parts / Ersatzteile		
		DC	ZEFP	DCON	LF	APMX		Sıkma Vidası Screw Schraube	Tork Anahtar Torx Key Torx-Schlüssel	Montaj Vidası Mounting Screw Befestigungsschraube
AFM90-AN11-D040-A16-Z04-H	●	40	4	16	40	11	ANGX 1105..	4010-M3x8	82-T10	2506-M8x30
AFM90-AN1506-D050-A22-Z04-H	●	50	4	22	40	14.5				ANGX 1506..
AFM90-AN1506-D063-A22-Z05-H	●	63	5	22	40	14.5	2510-M12x35			
AFM90-AN1506-D080-A27-Z06-H	●	80	6	27	50	14.5	2514-M16x35			
AFM90-AN1506-D100-A32-Z08-H	●	100	8	32	50	14.5	-			
AFM90-AN1506-D125-B40-Z09	●	125	9	40	63	14.5				
AFM90-AN1506-D160-C40-Z10	●	160	10	40	63	14.5				

ZCC Ucuna Uygun. / Compatible with ZCC Insert. / Kompatibel mit ZCC Wendeplatten.

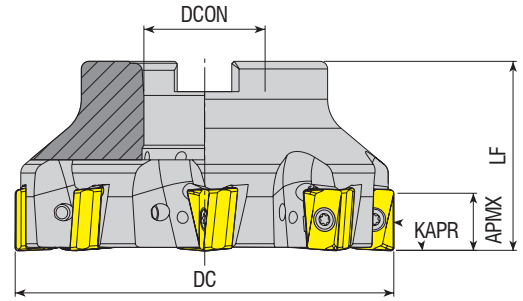

Takım Kodu Ordering Code Bestell-Bezeichnung	Stok Stock Lager	Takım Ölçüleri (mm) Dimension (mm) Abmessung (mm)					Kesici Uç Insert Wendeschneidplatte	Yedek Parçaları / Spare Parts / Ersatzteile		
		DC	ZEFP	DCON	LF	APMX		Sıkma Vidası Screw Schraube	Tork Anahtar Torx Key Torx-Schlüssel	Montaj Vidası Mounting Screw Befestigungsschraube
AFM90-AN1607-D050-A22-Z04-H	●	50	4	22	40	15	AN.X 1607..	4015-M4x11	80-T15	2508-M10x30
AFM90-AN1607-D063-A22-Z06-H	●	63	6	22	40	15				2510-M12x35
AFM90-AN1607-D080-A27-Z07-H	●	80	7	27	50	15				2514-M16x35
AFM90-AN1607-D100-A32-Z08-H	●	100	8	32	50	15				-
AFM90-AN1607-D125-B40-Z10	●	125	10	40	63	15				

R: Sağ / Right / Rechts L: Sol / Left / Links

● Stokta / In Stock / Auf Lager ○ Stokta Yok / Non Stock Item / Kein Lagerartikel, Lieferzeit auf Anfrage

TGTC Ucuna Uygun. / Compatible with TGTC Insert. / Kompatibel mit TGTC Wendeplatten.

Sipariş Örneği/Ordering Example/Bestellbeispiel

1 ad./pcs./stück AFM90-AN11-D040-A16-Z04-H

Kesme Hesabı : S 377 / Cutting Calculation : P 377 / Schnittberechnung : P 377

Montaj Ölçüleri : S 374 / Mounting Reference : P 374 / Montagehinweis : P 374

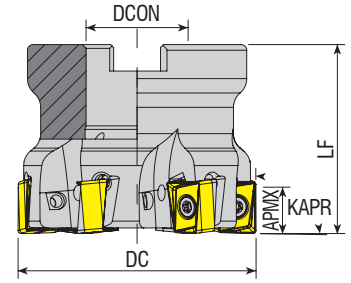

Takım Kodu Ordering Code Bestell-Bezeichnung	Stok Stock Lager	Takım Ölçüleri (mm) Dimension (mm) Abmessung (mm)					Kesici Uç Insert Wendeschneidplatte	Yedek Parçaları / Spare Parts / Ersatzteile		
		DC	ZEFP	DCON	LF	APMX		Sıkma Vidası Screw Schraube	Tork Anahtar Torx Key Torx-Schlüssel	Montaj Vidası Mounting Screw Befestigungsschraube
AFM90-AN12-D040-A16-Z04-H	●	40	4	16	40	12	ANKX 1205..	4015-M4x12	80-T15	2406-M8x30
AFM90-AN12-D050-A22-Z05-H	●	50	5	22	40	12				2508-M10x30
AFM90-AN12-D063-A27-Z06-H	●	63	6	27	50	12				2510-M12x35

ISCR Ucuna Uygundur. / Compatible with ISCR Insert. / Kompatibel mit ISCR Wendeplatten.

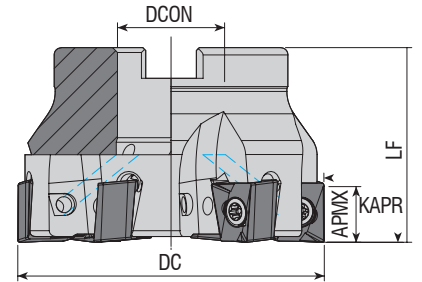

Takım Kodu Ordering Code Bestell-Bezeichnung	Stok Stock Lager	Takım Ölçüleri (mm) Dimension (mm) Abmessung (mm)					Kesici Uç Insert Wendeschneidplatte	Yedek Parçaları / Spare Parts / Ersatzteile		
		DC	ZEFP	DCON	LF	APMX		Sıkma Vidası Screw Schraube	Tork Anahtar Torx Key Torx-Schlüssel	Montaj Vidası Mounting Screw Befestigungsschraube
AFM90-AN1207-D040-A16-Z04-H	●	40	4	16	40	10	ANKX 1207..	4015-M4x11	80-T15	2506-M8x30
AFM90-AN1207-D050-A22-Z05-H	●	50	5	22	40	10				2508-M10x30
AFM90-AN1207-D063-A22-Z06-H	●	63	6	22	40	10				2510-M12x35
AFM90-AN1607X-D050-A22-Z04-H	●	50	4	22	40	15	ANKX 1607..	4015-M4x11	80-T15	2508-M10x30
AFM90-AN1607X-D063-A22-Z06-H	●	63	6	22	40	15				2510-M12x35
AFM90-AN1607X-D080-A27-Z07-H	●	80	7	27	50	15				2510-M12x35

R: Sağ / Right / Rechts L: Sol / Left / Links

● Stokta / In Stock / Auf Lager ○ Stokta Yok / Non Stock Item / Kein Lagerartikel, Lieferzeit auf Anfrage

XTC-GSC Ucuna Uygundur. / Compatible with XTC-GSC Insert. / Kompatibel mit XTC-GSC Wendeplatten.

Sipariş Örneği/Ordering Example/Bestellbeispiel

1 ad./pcs./stück AFM90-AN12-D040-A16-Z04-H

Kesme Hesabı : S 377 / Cutting Calculation : P 377 / Schnittberechnung : P 377

Montaj Ölçüleri : S 374 / Mounting Reference : P 374 / Montagehinweis : P374

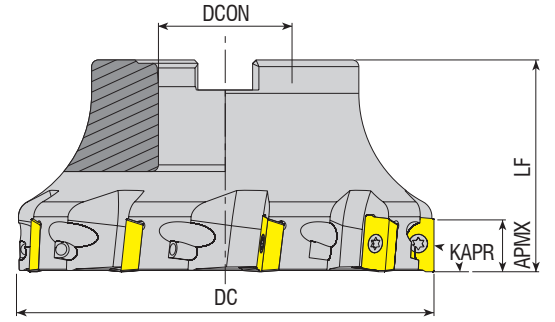

Takım Kodu Ordering Code Bestell-Bezeichnung	Stok Stock Lager	Takım Ölçüleri (mm) Dimension (mm) Abmessung (mm)					Kesici Uç Insert Wendeschneidplatte	Yedek Parçaları / Spare Parts / Ersatzteile		
		DC	ZEFP	DCON	LF	APMX		Sıkma Vidası Screw Schraube	Tork Anahtar Torx Key Torx-Schlüssel	Montaj Vidası Mounting Screw Befestigungsschraube
• AFM90-AP10-D040-A16-Z04-H	●	40	4	16	35	10	AP. 1003.. ISO UCUNA UYGUNDUR. FOR ISO INSERT. Kompatibel mit ISO Wendepfatten.	3008-M2.5x6	82-T08	2506-M8x30
• AFM90-AP10-D040-A16-Z05-H	●	40	5	16	40	10				2508-M10x30
• AFM90-AP10-D050-A22-Z06-H	●	50	6	22	40	10				3008-M2.5x6
• AFM90-AP10-D050-A22-Z07-H	●	50	7	22	40	10				2508-M10x30
• AFM90-AP10-D063-A22-Z06	●	63	6	22	40	10				3008-M2.5x6
• AFM90-AP10-D063-A22-Z07-H	●	63	7	22	40	10				2510-M12x35
• AFM90-AP10-D063-A22-Z09	●	63	9	22	40	10				2514-M16x35
• AFM90-AP10-D080-A27-Z08-H	●	80	8	27	50	10				2506-M8x30
• AFM90-AP10-D100-A32-Z09-H	●	100	9	32	50	10				2508-M10x30
• AFM90-AP16-D040-A16-Z04-H	●	40	4	16	40	16				AP. 1604.. ISO UCUNA UYGUNDUR. FOR ISO INSERT. Kompatibel mit ISO Wendepfatten.
• AFM90-AP16-D050-A22-Z05-H	●	50	5	22	40	16	2506-M8x30			
• AFM90-AP16-D052-A22-Z05-H	●	52	5	22	40	16	2508-M10x30			
• AFM90-AP16-D063-A22-Z06-H	●	63	6	22	40	16	2510-M12x35			
• AFM90-AP16-D080-A27-Z07-H	●	80	7	27	50	16	2514-M16x35			
• AFM90-AP16-D100-A32-Z08-H	●	100	8	32	50	16	-			
• AFM90-AP16-D125-B40-Z09	●	125	9	40	63	16	2508-M10x30			
• AFM90-AP16-D160-C40-Z10	●	160	10	40	63	16	2510-M12x35			
• AFM90-AP16-D200-C60-Z12	●	200	12	60	63	16	2514-M16x35			
• AFM90-AP16DJ-D050-A22-Z05-H	●	50	5	22	40	16	AP. 1604.. DJT UCUNA UYGUNDUR. FOR DJT INSERT. Kompatibel mit DJT	4015-M4x11	80-T15	
• AFM90-AP16DJ-D063-A22-Z06-H	●	63	6	22	40	16				2510-M12x35
• AFM90-AP16L-D050-A22-Z05-H	●	50	5	22	40	16				2508-M10x30
• AFM90-AP16L-D063-A22-Z06-H	●	63	6	22	40	16				2510-M12x35
• AFM90-AP16L-D080-A27-Z07-H	●	80	7	27	50	16				2506-M8x30
• AFM90-AP16P-D040-A16-Z04-H	●	40	4	16	40	16				2508-M10x30
• AFM90-AP16P-D050-A22-Z05-H	●	50	5	22	40	16				2510-M12x35
• AFM90-AP16P-D063-A22-Z06-H	●	63	6	22	40	16				2514-M16x35
• AFM90-AP16P-D080-A27-Z07-H	●	80	7	27	50	16				2508-M10x30
• AFM90-AP16P-D100-A32-Z08-H	●	100	8	32	50	16				2510-M12x35
• AFM90-AP16A-D050-A22-Z05-H	●	50	5	22	40	15	AP. 1604.. ACHTK UCUNA UYGUNDUR. FOR ACHTK INSERT. Kompatibel mit ACHTK	4015-M4x11	80-T15	2514-M16x35
• AFM90-AP16A-D063-A22-Z06-H	●	63	6	22	40	15				2508-M10x30
• AFM90-AP16A-D080-A27-Z07-H	●	80	7	27	50	15				2510-M12x35
• AFM90-AP16A-D100-A32-Z08-H	●	100	8	32	50	15				2514-M16x35
• AFM90-AP16A-D125-B40-Z09	●	125	9	40	63	15				-
• AFM90-AP16Y-D040-A16-Z04-H	●	40	4	16	40	16				2506-M8x30
• AFM90-AP16Y-D050-A22-Z05-H	●	50	5	22	40	16				2508-M10x30
• AFM90-AP16Y-D063-A22-Z06-H	●	63	6	22	40	16				2510-M12x30
• AFM90-AP16Y-D080-A27-Z07-H	●	80	7	27	50	16				2510-M12x35
• AFM90-AP16Y-D100-A32-Z08-H	●	100	8	32	50	16				

R: Sağ / Right / Rechts L: Sol / Left / Links

● Stokta / In Stock / Auf Lager ○ Stokta Yok / Non Stock Item / Kein Lagerartikel, Lieferzeit auf Anfrage

Sipariş Örneği/Ordering Example/Bestellbeispiel

1 ad./pcs./stück AFM90-AP10-D040-A16-Z04-H

Kesme Hesabı : S 377 / Cutting Calculation : P 377 / Schnittberechnung : P 377

Montaj Ölçüleri : S 374 / Mounting Reference : P 374 / Montagehinweis : P374

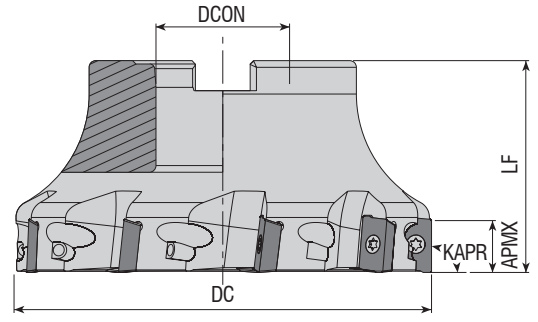

Takım Kodu Ordering Code Bestell-Bezeichnung	Stok Stock Lager	Takım Ölçüleri (mm) Dimension (mm) Abmessung (mm)					Kesici Uç Insert Wendeschneidplatte	Yedek Parçaları / Spare Parts / Ersatzteile		
		DC	ZEFP	DCON	LF	APMX		Sıkma Vidası Screw Schraube	Tork Anahtar Torx Key Torx-Schlüssel	Montaj Vidası Mounting Screw Befestigungsschraube
AFM90-AP1705-D050-A22-Z05-H	●	50	5	22	40	16	AP. 1705..	4015-M4x11	80-T15	2508-M10x30 2510-M12x35 2514-M16x35
AFM90-AP1705-D063-A22-Z06-H	●	63	6	22	40	16				
AFM90-AP1705-D080-A27-Z07-H	●	80	7	27	50	16				
AFM90-AP1705-D100-A32-Z08-H	●	100	8	32	50	16				

TGTC Ucuna Uygun. / Compatible with TGTC Insert. / Kompatibel mit TGTC Wendeplatten.

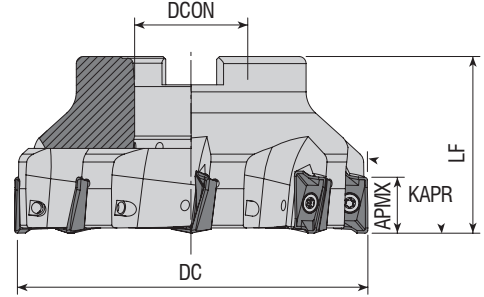

Takım Kodu Ordering Code Bestell-Bezeichnung	Stok Stock Lager	Takım Ölçüleri (mm) Dimension (mm) Abmessung (mm)					Kesici Uç Insert Wendeschneidplatte	Yedek Parçaları / Spare Parts / Ersatzteile		
		DC	ZEFP	DCON	LF	APMX		Sıkma Vidası Screw Schraube	Tork Anahtar Torx Key Torx-Schlüssel	Montaj Vidası Mounting Screw Befestigungsschraube
AFM90-AX1235-D040-A16-Z06-H	●	40	6	16	40	10	AX.T 1235..	3108-M3x6	82-T08	2506-M8x30 2508-M10x30 2510-M12x35
AFM90-AX1235-D050-A22-Z07-H	●	50	7	22	40	10				
AFM90-AX1235-D063-A22-Z08-H	●	63	8	22	40	10				
AFM90-AX1705-D040-A16-Z04-H	●	40	4	16	40	14	AX.T 1705..	4015-M4x11	80-T15	2506-M8x30 2508-M10x30 2510-M12x35 2514-M16x35
AFM90-AX1705-D050-A22-Z05-H	●	50	5	22	40	14				
AFM90-AX1705-D063-A22-Z06-H	●	63	6	22	40	14				
AFM90-AX1705-D080-A27-Z07-H	●	80	7	27	50	14				
AFM90-AX1705-D100-A32-Z08-H	●	100	8	32	50	14				

R: Sağ / Right / Rechts L: Sol / Left / Links

● Stokta / In Stock / Auf Lager ○ Stokta Yok / Non Stock Item / Kein Lagerartikel, Lieferzeit auf Anfrage  
SMTM Ucuna Uygun. / Compatible with SMTM Insert. / Kompatibel mit SMTM Wendeplatten.

Sipariş Örneği/Ordering Example/Bestellbeispiel

1 ad./pcs./stück AFM90-AP1705-D050-A22-Z05-H

Kesme Hesabı : S 377 / Cutting Calculation : P 377 / Schnittberechnung : P 379

Montaj Ölçüleri : S 374 / Mounting Reference : P 374 / Montagehinweis : P374

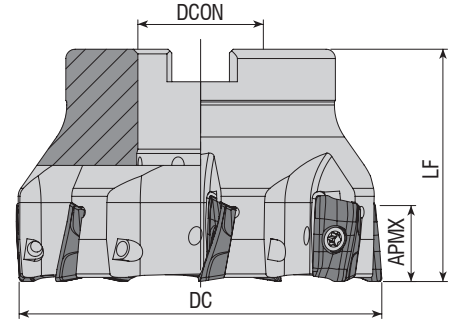

Takım Kodu Ordering Code Bestell-Bezeichnung	Stok Stock Lager	Takım Ölçüleri (mm) Dimension (mm) Abmessung (mm)					Kesici Uç Insert Wendeschneidplatte	Yedek Parçaları / Spare Parts / Ersatzteile		
		DC	ZEFP	DCON	LF	APMX		Sıkma Vidası Screw Schraube	Tork Anahtar Torx Key Torx-Schlüssel	Montaj Vidası Mounting Screw Befestigungsschraube
AFM90-BD11T3-D040-A16-Z04-H	●	40	4	16	40	10	BDMT 11T3..	3008-M2.5x6	82-T08	2506-M8x30
AFM90-BD11T3-D040-A16-Z05-H	●	40	5	16	40	10				
AFM90-BD11T3-D050-A22-Z05-H	●	50	5	22	40	10				
AFM90-BD11T3-D063-A22-Z06-H	●	63	6	22	40	10				
AFM90-BD1704-D050-A22-Z04-H	●	50	4	22	40	15.7	BDMT 1704..	4015-M4x11	80-T15	2508-M10x30
AFM90-BD1704-D050-A22-Z05-H	●	50	5	22	40	15.7				
AFM90-BD1704-D063-A22-Z06-H	●	63	6	22	40	15.7				
AFM90-BD1704-D080-A27-Z06-H	●	80	6	27	50	15.7				
AFM90-BD1704-D080-A27-Z07-H	●	80	7	27	50	15.7				
AFM90-BD1704-D100-A32-Z07-H	●	100	7	32	50	15.7				

KYCR Ucuna Uygundur. / Compatible with KYCR Insert. / Kompatibel mit KYCR Wendeplatten.

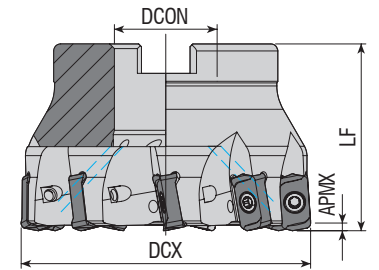

Takım Kodu Ordering Code Bestell-Bezeichnung	Stok Stock Lager	Takım Ölçüleri (mm) Dimension (mm) Abmessung (mm)					Kesici Uç Insert Wendeschneidplatte	Yedek Parçaları / Spare Parts / Ersatzteile		
		DC	ZEFP	DCON	LF	APMX		Sıkma Vidası Screw Schraube	Tork Anahtar Torx Key Torx-Schlüssel	Montaj Vidası Mounting Screw Befestigungsschraube
AFM90-LO1004-D040-A16-Z05-H	●	40	5	16	40	10	LOMU 1004..	1108-M3x6.8	82-T08	2506-M8x30
AFM90-LO1004-D050-A22-Z05-H	●	50	5	22	40	10				
AFM90-LO1004-D063-A22-Z06-H	●	63	6	22	40	10				
AFM90-LO1505-D050-A22-Z04-H	●	50	4	22	40	15	LOMU 1505..	3015-M4x11	80-T15	2508-M10x30
AFM90-LO1505-D063-A22-Z05-H	●	63	5	22	40	15				

R: Sağ / Right / Rechts L: Sol / Left / Links

● Stokta / In Stock / Auf Lager ○ Stokta Yok / Non Stock Item / Kein Lagerartikel, Lieferzeit auf Anfrage  
KYCR Ucuna Uygundur. / Compatible with KYCR Insert. / Kompatibel mit KYCR Wendeplatten.

Sipariş Örneği/Ordering Example/Bestellbeispiel

1 ad./pcs./stück AFM90-BD11T3-D040-A16-Z04-H

Kesme Hesabı : S 377 / Cutting Calculation : P 377 / Schnittberechnung : P 377

Montaj Ölçüleri : S 374 / Mounting Reference : P 374 / Montagehinweis : P374

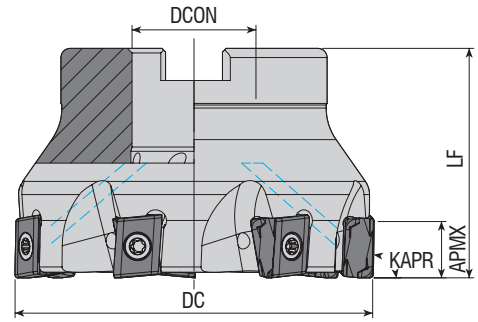

Takım Kodu Ordering Code Bestell-Bezeichnung	Stok Stock Lager	Takım Ölçüleri (mm) Dimension (mm) Abmessung (mm)					Kesici Uç Insert Wendeschneidplatte	Yedek Parçaları / Spare Parts / Ersatzteile		
		DC	ZEFP	DCON	LF	APMX		Sıkma Vidası Screw Schraube	Tork Anahtar Torx Key Torx-Schlüssel	Montaj Vidası Mounting Screw Befestigungsschraube
AFM90-LN1506X-D063-A22-Z06	●	63	6	22	40	7	LNMT 1506..	3015-M4x11	80-T15	2508-M10x30
AFM90-LN1506X-D080-A27-Z07	●	80	7	27	50	7				2510-M12x35
AFM90-LN1506X-D100-A32-Z08	●	100	8	32	50	7				2514-M16x35

R: Sağ / Right / Rechts L: Sol / Left / Links

● Stokta / In Stock / Auf Lager ○ Stokta Yok / Non Stock Item / Kein Lagerartikel, Lieferzeit auf Anfrage

XTC-GSC Ucuna Uygundur. / Compatible with XTC-GSC Insert. / Kompatibel mit XTC-GSC Wendeplatten.

Kesme Hesabı : S 377 / Cutting Calculation : P 377 / Schnittberechnung : P 377

Montaj Ölçüleri : S 374 / Mounting Reference : P 374 / Montagehinweis : P374

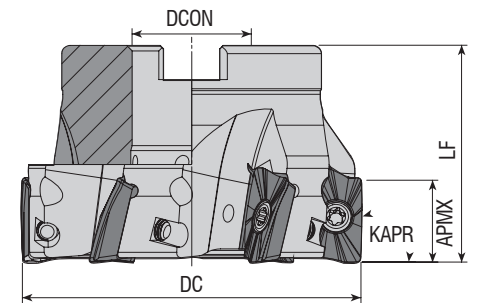

Takım Kodu Ordering Code Bestell-Bezeichnung	Stok Stock Lager	Takım Ölçüleri (mm) Dimension (mm) Abmessung (mm)					Kesici Uç Insert Wendeschneidplatte	Yedek Parçaları / Spare Parts / Ersatzteile		
		DC	ZEFP	DCON	LF	APMX		Sıkma Vidası Screw Schraube	Tork Anahtar Torx Key Torx-Schlüssel	Montaj Vidası Mounting Screw Befestigungsschraube
AFM90-A01236-D050-A22-Z05-H	●	50	5	22	40	10	AO.. 1236..	3008-M2.5x6	82-T08	2508-M10x30
AFM90-A01848-D050-A22-Z05-H	●	50	5	22	40	15	AO.. 1848..	4015-M4x11	80-T15	
AFM90-A01848-D063-A22-Z06-H	●	63	6	22	40	15				

MTSBH Ucuna Uygundur. / Compatible with MTSBH Insert. / Kompatibel mit MTSBH Wendeplatten.

Sipariş Örneği/Ordering Example/Bestellbeispiel

1 ad./pcs./stück AFM90-LN1506X-D063-A22-Z06

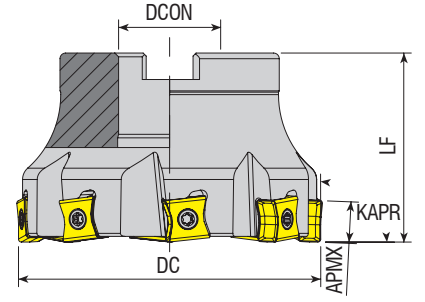

Takım Kodu Ordering Code Bestell-Bezeichnung	Stok Stock Lager	Takım Ölçüleri (mm) Dimension (mm) Abmessung (mm)					Kesici Uç Insert Wendeschneidplatte	Yedek Parçaları / Spare Parts / Ersatzteile		
		DC	ZEFP	DCON	LF	APMX		Sıkma Vidası Screw Schraube	Tork Anahtar Torx Key Torx-Schlüssel	Montaj Vidası Mounting Screw Befestigungsschraube
AFM90-LN1106-D050-A22-Z05	●	50	5	22	40	10	LNMT 1106..	4015-M3.5x11	80-T15	2508-M10x30
AFM90-LN1106-D063-A22-Z06	●	63	6	22	40	10				2510-M12x35
AFM90-LN1106-D080-A27-Z08	●	80	8	27	50	10				2514-M16x35
AFM90L-LN1106-D080-A27-Z08	●	80	8	27	50	10				-
AFM90-LN1106-D100-A32-Z09	●	100	9	32	50	10				2506-M8x30
AFM90L-LN1106-D100-A32-Z09	●	100	9	32	50	10				2508-M10x30
AFM90-LN1106-D125-B40-Z10	●	125	10	40	63	10				2510-M12x35
AFM90-LN1306-D040-A16-Z04-H	●	40	4	16	40	12.5	T490 LNMT 1306..	4015-M4x11	80-T15	2514-M16x35
AFM90-LN1306-D050-A22-Z05-H	●	50	5	22	40	12.5				2506-M8x30
AFM90-LN1306-D063-A22-Z06-H	●	63	6	22	40	12.5				2508-M10x30
AFM90-LN1306-D080-A27-Z07-H	●	80	7	27	50	12.5				2510-M12x35
AFM90-LN1306-D100-A32-Z08-H	●	100	8	32	50	12.5	LNMT 1506..	4015-M4x11	80-T20	2514-M16x35
AFM90L-LN1506-D040-A16-Z04	●	40	4	16	40	14				2506-M8x30
AFM90-LN1506-D040-A16-Z04	○	40	4	16	40	14				2508-M10x30
AFM90-LN1506-D050-A22-Z05	○	50	5	22	40	14				2510-M12x35
AFM90-LN1506-D063-A22-Z06	○	63	6	22	40	14				2514-M16x35
AFM90-LN1506-D080-A27-Z07	○	80	7	27	50	14				2506-M8x30
AFM90-LN1607-D050-A22-Z03-H	●	50	3	22	40	16	T490 LNHT 1607..	4420-M5x14	80-T20	2508-M10x30
AFM90-LN1607-D063-A22-Z04-H	○	63	4	22	40	16				2510-M12x35
AFM90-LN1607-D080-A27-Z05-H	●	80	5	27	50	16				2514-M16x35
AFM90-LN1607-D100-A32-Z06-H	●	100	6	32	50	16				2506-M8x30

R: Sağ / Right / Rechts L: Sol / Left / Links

● Stokta / In Stock / Auf Lager ○ Stokta Yok / Non Stock Item / Kein Lagerartikel, Lieferzeit auf Anfrage  
ISCR Ucuna Uygunudur. / Compatible with ISCR Insert. / Kompatibel mit ISCR Wendepfatten.

Sipariş Örneği/Ordering Example/Bestellbeispiel

1 ad./pcs./stück AFM90-LN1106-D050-A22-Z05

Kesme Hesabı : S 377 / Cutting Calculation : P 377 / Schnittberechnung : P 377

Montaj Ölçüleri : S 374 / Mounting Reference : P 374 / Montagehinweis : P 374



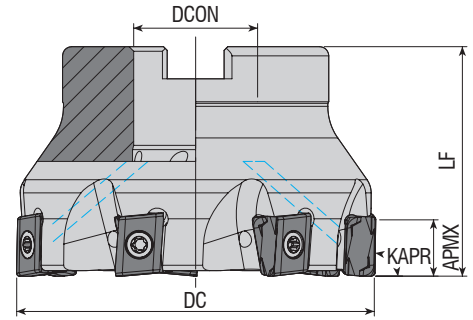

Takım Kodu Ordering Code Bestell-Bezeichnung	Stok Stock Lager	Takım Ölçüleri (mm) Dimension (mm) Abmessung (mm)					Kesici Uç Insert Wendeschneidplatte	Yedek Parçaları / Spare Parts / Ersatzteile		
		DC	ZEFP	DCON	LF	APMX		Sıkma Vidası Screw Schraube	Tork Anahtar Torx Key Torx-Schlüssel	Montaj Vidası Mounting Screw Befestigungsschraube
<b>new</b> AFM90-LN1306W-D040-A16-Z04-H	●	40	4	16	40	12	LNHU 1306..	4115-M4x12	80-T15	2506-M8x30
AFM90-LN1306W-D050-A22-Z05-H	●	50	5	22	40	12				2508-M10x30
AFM90-LN1306W-D063-A22-Z06-H	●	63	6	22	40	12				2510-M12x35
AFM90-LN1306W-D080-A27-Z07-H	●	80	7	27	50	12				2514-M16x35
<b>new</b> AFM90-LN1306W-D100-A32-Z08-H	●	100	8	32	50	12				

WLTR Ucuna Uygun. / Compatible with WLTR Insert. / Kompatibel mit WLTR Wendeplatten.

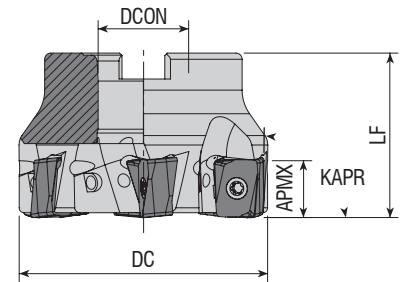

Takım Kodu Ordering Code Bestell-Bezeichnung	Stok Stock Lager	Takım Ölçüleri (mm) Dimension (mm) Abmessung (mm)					Kesici Uç Insert Wendeschneidplatte	Yedek Parçaları / Spare Parts / Ersatzteile		
		DC	ZEFP	DCON	LF	APMX		Sıkma Vidası Screw Schraube	Tork Anahtar Torx Key Torx-Schlüssel	Montaj Vidası Mounting Screw Befestigungsschraube
AFM90-LN1307-D050-A22-Z04-H	●	50	4	22	40	13	LNGX 1307..	1315-M4x11	80-T15	2508-M10x30
AFM90-LN1307-D063-A22-Z06-H	●	63	6	22	40	13				2510-M12x35
AFM90-LN1307-D080-A27-Z07-H	●	80	7	27	50	13				2514-M16x35
AFM90-LN1307-D100-A32-Z08-H	●	100	8	32	50	13				

R: Sağ / Right / Rechts L: Sol / Left / Links

● Stokta / In Stock / Auf Lager ○ Stokta Yok / Non Stock Item / Kein Lagerartikel, Lieferzeit auf Anfrage

WLTR Ucuna Uygun. / Compatible with WLTR Insert. / Kompatibel mit WLTR Wendeplatten.

Sipariş Örneği/Ordering Example/Bestellbeispiel

1 ad./pcs./stück AFM90-LN1306W-D040-A16-Z04-H

Kesme Hesabı : S 367 / Cutting Calculation : P 367 / Schnittberechnung : P 367

Montaj Ölçüleri : S 364 / Mounting Reference : P 364 / Montagehinweis : P364

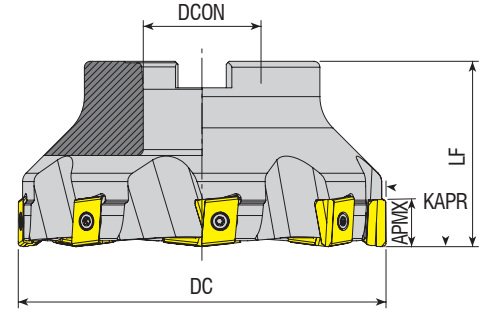

Takım Kodu Ordering Code Bestell-Bezeichnung	Stok Stock Lager	Takım Ölçüleri (mm) Dimension (mm) Abmessung (mm)					Kesici Uç Insert Wendeschneidplatte	Yedek Parçaları / Spare Parts / Ersatzteile		
		DC	ZEFP	DCON	LF	APMX		Sıkma Vidası Screw Schraube	Tork Anahtar Torx Key Torx-Schlüssel	Montaj Vidası Mounting Screw Befestigungsschraube
AFM90-LN15Z-D050-A22-Z04	●	50	4	22	40	15	LNKT 1506..	4015-M4x11	80-T15	2508-M10x30
AFM90-LN15Z-D063-A22-Z05	●	63	5	22	40	15				2510-M12x35
AFM90-LN15Z-D080-A27-Z06	●	80	6	27	50	15				2514-M16x35
AFM90-LN15Z-D100-A32-Z07	●	100	7	32	50	15				-
AFM90-LN15Z-D125-B40-Z08	●	125	8	40	63	15				-

ZCC Ucuna Uygunudur. / Compatible with ZCC Insert. / Kompatibel mit ZCC Wendeplatten.

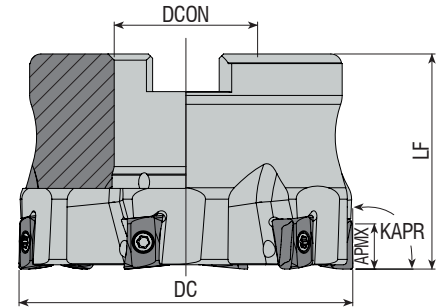

Takım Kodu Ordering Code Bestell-Bezeichnung	Stok Stock Lager	Takım Ölçüleri (mm) Dimension (mm) Abmessung (mm)					Kesici Uç Insert Wendeschneidplatte	Yedek Parçaları / Spare Parts / Ersatzteile		
		DC	ZEFP	DCON	LF	APMX		Sıkma Vidası Screw Schraube	Tork Anahtar Torx Key Torx-Schlüssel	Montaj Vidası Mounting Screw Befestigungsschraube
AFM90-L008-D040-A16-Z06-H	●	40	6	16	40	2	LOEX 0804..	3008-M2.5x8	82-T08	2506-M8x30
AFM90-L008-D050-A22-Z07-H	●	50	7	22	40	2				2508-M10x30
AFM90-L008-D063-A27-Z06-H	●	63	6	27	40	2				2510-M12x35

R: Sağ / Right / Rechts L: Sol / Left / Links  
● Stokta / In Stock / Auf Lager ○ Stokta Yok / Non Stock Item / Kein Lagerartikel, Lieferzeit auf Anfrage  
SC Ucuna Uygunudur. / Compatible with SC Insert. / Kompatibel mit SC Wendeplatten.

Sipariş Örneği/Ordering Example/Bestellbeispiel  
1 ad./pcs./stück AFM90-LN15Z-D050-A22-Z04  
Kesme Hesabı : S 367 / Cutting Calculation : P 367 / Schnittberechnung : P 367  
Montaj Ölçüleri : S 364 / Mounting Reference : P 364 / Montagehinweis : P 364

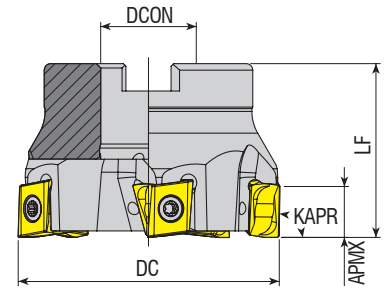

Takım Kodu Ordering Code Bestell-Bezeichnung	Stok Stock Lager	Takım Ölçüleri (mm) Dimension (mm) Abmessung (mm)					Kesici Uç Insert Wendeschneidplatte	Yedek Parçaları / Spare Parts / Ersatzteile		
		DC	ZEP	DCON	LF	APMX		Sıkma Vidası Screw Schraube	Tork Anahtar Torx Key Torx-Schlüssel	Montaj Vidası Mounting Screw Befestigungsschraube
<b>new</b> AFM90-L00904-D040-A16-Z06-H	●	40	6	16	40	8	LOGU 0904..		82-T07	2506-M8x30
<b>new</b> AFM90-L00904-D050-A22-Z05-H	●	50	5	22	40	8				2508-M10x30
<b>new</b> AFM90-L00904-D050-A22-Z07-H	●	50	7	22	40	8				2506-M8x30
<b>new</b> AFM90-L00904-D063-A22-Z06-H	●	63	6	22	40	8	LOGU 1207..		80-T15	2508-M10x30
AFM90-L01207-D040-A16-Z04-H	●	40	4	16	40	11				2506-M8x30
AFM90-L01207-D050-A22-Z05-H	●	50	5	22	40	11				2508-M10x30
AFM90-L01207-D063-A22-Z05-H	●	63	5	22	40	11				2510-M12x35
<b>new</b> AFM90-L01207-D063-A22-Z06-H	●	63	6	22	40	11				2514-M16x35
<b>new</b> AFM90-L01207-D080-A27-Z07-H	●	80	7	27	50	11				
<b>new</b> AFM90-L01207-D100-A32-Z07-H	●	100	7	32	50	11				

MTSBH Ucuna Uygun. / Compatible with MTSBH Insert. / Kompatibel mit MTSBH Wendeplatten.

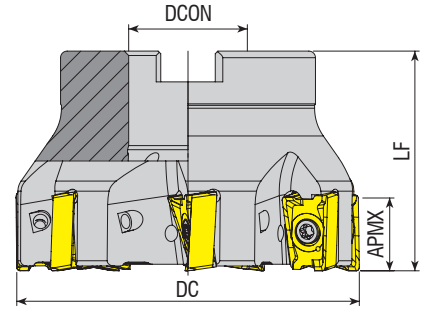

Takım Kodu Ordering Code Bestell-Bezeichnung	Stok Stock Lager	Takım Ölçüleri (mm) Dimension (mm) Abmessung (mm)					Kesici Uç Insert Wendeschneidplatte	Yedek Parçaları / Spare Parts / Ersatzteile		
		DC	ZEP	DCON	LF	APMX		Sıkma Vidası Screw Schraube	Tork Anahtar Torx Key Torx-Schlüssel	Montaj Vidası Mounting Screw Befestigungsschraube
AFM90-LN15T6-D050-A22-Z05-H	●	50	5	22	40	15.5	LNGU 15T6..		80-T15	2508-M10x30
AFM90-LN15T6-D063-A22-Z06-H	●	63	6	22	40	15.5				2510-M12x35
AFM90-LN15T6-D080-A27-Z07-H	●	80	7	27	50	15.5				

R: Sağ / Right / Rechts L: Sol / Left / Links

● Stokta / In Stock / Auf Lager ○ Stokta Yok / Non Stock Item / Kein Lagerartikel, Lieferzeit auf Anfrage  
KNMTL Ucuna Uygun. / Compatible with KNMTL Insert. / Kompatibel mit KNMTL Wendeplatten.

Sipariş Örneği/Ordering Example/Bestellbeispiel  
1 ad./pcs./stück AFM90-L009-D040-A16-Z06-H

Kesme Hesabı : S 377 / Cutting Calculation : P 377 / Schnittberechnung : P 377  
Montaj Ölçüleri : S 374 / Mounting Reference : P 374 / Montagehinweis : P374

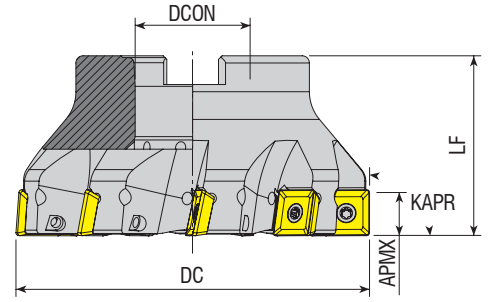

Takım Kodu Ordering Code Bestell-Bezeichnung	Stok Stock Lager	Takım Ölçüleri (mm) Dimension (mm) Abmessung (mm)					Kesici Uç Insert Wendeschneidplatte	Yedek Parçaları / Spare Parts / Ersatzteile		
		DC	ZEFP	DCON	LF	APMX		Sıkma Vidası Screw Schraube	Tork Anahtar Torx Key Torx-Schlüssel	Montaj Vidası Mounting Screw Befestigungsschraube
AFM90-R290.12-D050-A22-Z04-H	●	50	4	22	40	10.7				
AFM90-R290.12-D063-A22-Z05-H	●	63	5	22	40	10.7				
AFM90-R290.12-D080-A27-Z07-H	●	80	7	27	50	10.7				
AFM90-R290.12-D100-A32-Z09-H	●	100	9	32	50	10.7				
AFM90-R290.12-D125-B40-Z11	●	125	11	40	63	10.7				

SNDVK Ucuna Uygundur. / Compatible with SNDVK Insert. / Kompatibel mit SNDVK Wendepfetten.

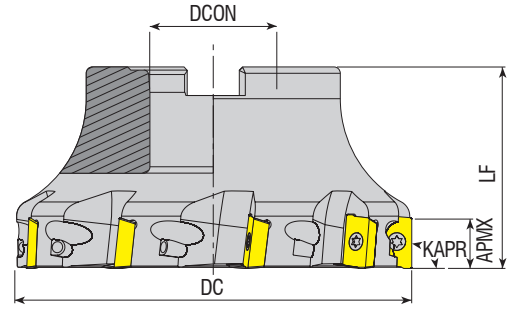

Takım Kodu Ordering Code Bestell-Bezeichnung	Stok Stock Lager	Takım Ölçüleri (mm) Dimension (mm) Abmessung (mm)					Kesici Uç Insert Wendeschneidplatte	Yedek Parçaları / Spare Parts / Ersatzteile		
		DC	ZEFP	DCON	LF	APMX		Sıkma Vidası Screw Schraube	Tork Anahtar Torx Key Torx-Schlüssel	Montaj Vidası Mounting Screw Befestigungsschraube
AFM90-R390.11-D040-A16-Z05-H	●	40	5	16	40	10				
AFM90-R390.11-D050-A22-Z06-H	●	50	6	22	40	10				
AFM90-R390.11-D063-A22-Z07-H	●	63	7	22	40	10				
AFM90-R390.11-D080-A27-Z09-H	●	80	9	27	50	10				
AFM90-R390.17-D040-A16-Z04-H	●	40	4	16	40	15.4				
AFM90-R390.17-D050-A22-Z05-H	●	50	5	22	40	15.4				
AFM90-R390.17-D063-A22-Z06-H	●	63	6	22	40	15.4				
AFM90-R390.17-D080-A27-Z07-H	●	80	7	27	50	15.4				
AFM90-R390.17-D100-A32-Z08-H	●	100	8	32	50	15.4				
AFM90-R390.17-D125-B40-Z09	●	125	9	40	63	15.4				
AFM90-R390.18-D050-A22-Z04-H	●	50	4	22	40	15.4				
AFM90-R390.18-D063-A22-Z05-H	●	63	5	22	40	15.4				
AFM90-R390.18-D080-A27-Z06-H	●	80	6	27	50	15.4				
AFM90-R390.18-D100-A32-Z07-H	●	100	7	32	50	15.4				
AFM90-R390.18-D125-B40-Z08	●	125	8	40	63	15.4				

R: Sağ / Right / Rechts L: Sol / Left / Links

● Stokta / In Stock / Auf Lager ○ Stokta Yok / Non Stock Item / Kein Lagerartikel, Lieferzeit auf Anfrage  
SNDVK Ucuna Uygundur. / Compatible with SNDVK Insert. / Kompatibel mit SNDVK Wendepfetten.

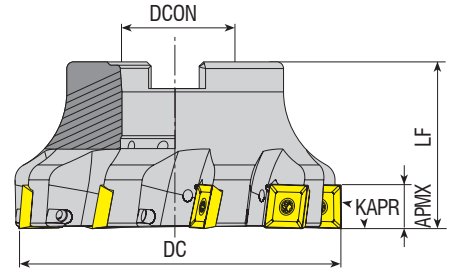

Takım Kodu Ordering Code Bestell-Bezeichnung	Stok Stock Lager	Takım Ölçüleri (mm) Dimension (mm) Abmessung (mm)					Kesici Uç Insert Wendeschneidplatte	Yedek Parçaları / Spare Parts / Ersatzteile		
		DC	ZEFP	DCON	LF	APMX		Sıkma Vidası Screw Schraube	Tork Anahtar Torx Key Torx-Schlüssel	Montaj Vidası Mounting Screw Befestigungsschraube
AFM90-490R08-D063-A22-Z06-H	●	63	6	22	40	5.5	490R-08T3..	3008-M2.5x6	82-T08	2508-M10x30
AFM90-490R14-D050-A22-Z04-H	●	50	4	22	40	10				
AFM90-490R14-D063-A22-Z05-H	●	63	5	22	40	10	490R-1404..	4015-M3.5x11	80-T15	2510-M12x35 2514-M16x35
AFM90-490R14-D080-A27-Z07-H	●	80	7	27	50	10				
AFM90-490R14-D100-A32-Z07-H	●	100	7	32	50	10				
AFM90-490R14-D125-B40-Z08	●	125	8	40	63	10				
new AFM90-490R14-D125-B40-Z12	●	125	12	40	63	10				
AFM90-490R14-D160-C40-Z12	●	160	12	40	63	10				
AFM90-490R14-D200-C60-Z16	●	200	16	60	63	10				

SNDVK Ucuna Uygunur. / Compatible with SNDVK Insert. / Kompatibel mit SNDVK Wendepfatten.

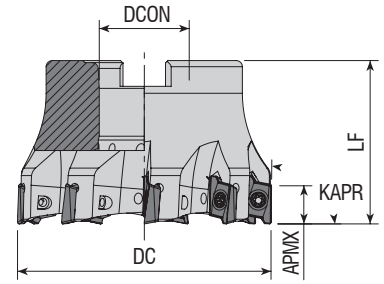

Takım Kodu Ordering Code Bestell-Bezeichnung	Stok Stock Lager	Takım Ölçüleri (mm) Dimension (mm) Abmessung (mm)					Kesici Uç Insert Wendeschneidplatte	Yedek Parçaları / Spare Parts / Ersatzteile		
		DC	ZEFP	DCON	LF	APMX		Sıkma Vidası Screw Schraube	Tork Anahtar Torx Key Torx-Schlüssel	Montaj Vidası Mounting Screw Befestigungsschraube
AFM90-RT10-D040-A16-Z06-H	●	40	6	16	40	10	RT 1003	3008-M2.5x6	82-T08	2506-M8x30 2407-M10x30
AFM90-RT10-D050-A22-Z07-H	●	50	7	22	40	10				
AFM90-RT10-D063-A22-Z09-H	●	63	9	22	40	10				
new AFM90-RT16-D040-A16-Z04-H	●	40	4	16	40	16	RT 1606	4015-M4x11	80-T15	2506-M8x30 2508-M10x30 2510-M12x35
new AFM90-RT16-D063-A22-Z06-H	●	63	6	22	40	16				
new AFM90-RT16-D080-A27-Z07-H	●	80	7	27	50	16				
new AFM90-RT16-D125-B40-Z09	●	125	9	40	63	16				

R: Sağ / Right / Rechts L: Sol / Left / Links

● Stokta / In Stock / Auf Lager ○ Stokta Yok / Non Stock Item / Kein Lagerartikel, Lieferzeit auf Anfrage  
SFTY Ucuna Uygunur. / Compatible with SFTY Insert. / Kompatibel mit SFTY Wendepfatten.

Sipariş Örneği/Ordering Example/Bestellbeispiel

1 ad./pcs./stück AFM90-490R08-D063-A22-Z06-H

Kesme Hesabı : S 377 / Cutting Calculation : P 377 / Schnittberechnung : P 377  
Montaj Ölçüleri : S 374 / Mounting Reference : P 374 / Montagehinweis : P 374

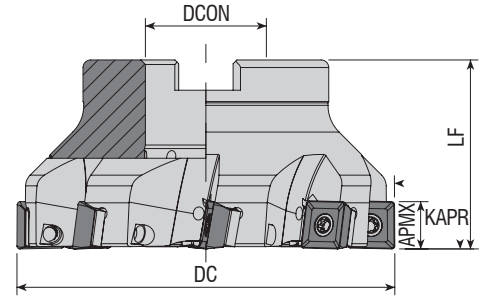

Takım Kodu Ordering Code Bestell-Bezeichnung	Stok Stock Lager	Takım Ölçüleri (mm) Dimension (mm) Abmessung (mm)					Kesici Uç Insert Wendeschneidplatte	Yedek Parçaları / Spare Parts / Ersatzteile				
		DC	ZEFP	DCON	LF	APMX		Altlık Screw Unterlage	Baskı Parçası Wedge Clamp Spannpratze	Sıkma Vidası Screw Schraube	Tork Anahtar Torx Key Torx-Schlüssel	Montaj Vidası Mounting Screw Befestigungsschraube
AFM90S-SD1204-D050-A22-Z04-H	●	50	4	22	40	11	SDMT 1204..	AASD-3-0001	AAV-08-M3.5x8	4015-M3.5x12	80-T15	2408-M10x30
AFM90S-SD1204-D063-A22-Z05-H	●	63	5	22	40	11						2508-M10x30
AFM90S-SD1204-D080-A27-Z06-H	●	80	6	27	50	11						2510-M12x35
AFM90S-SD1204-D100-A32-Z08-H	●	100	8	32	50	11						2514-M16x35
AFM90S-SD1204-D125-B40-Z10	●	125	10	40	63	11						-
AFM90S-SD1204-D160-C40-Z12	●	160	12	40	63	11						-

DJT Ucuna Uygunudur. / Compatible with DJT Insert. / Kompatibel mit DJT Wendepalten.

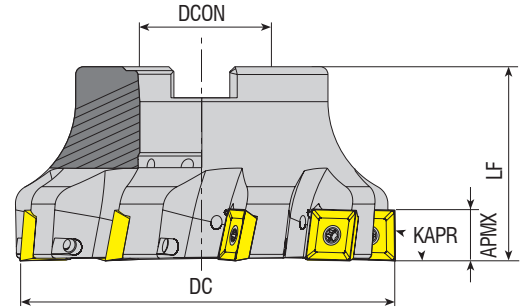

Takım Kodu Ordering Code Bestell-Bezeichnung	Stok Stock Lager	Takım Ölçüleri (mm) Dimension (mm) Abmessung (mm)					Kesici Uç Insert Wendeschneidplatte	Yedek Parçaları / Spare Parts / Ersatzteile		
		DC	ZEFP	DCON	LF	APMX		Sıkma Vidası Screw Schraube	Tork Anahtar Torx Key Torx-Schlüssel	Montaj Vidası Mounting Screw Befestigungsschraube
AFM90-SD09M4-D040-A16-Z04-H	●	40	4	16	40	9	SD.. 09M4..	4015-M3.5x11	80-T15	2406-M8x30
AFM90-SD09M4-D050-A22-Z05-H	●	50	5	22	40	9				2508-M10x30
AFM90-SD09M4-D063-A22-Z06-H	●	63	6	22	40	9				2510-M12x35
AFM90-SD09M4-D080-A27-Z07-H	●	80	7	27	50	9				2514-M16x35
AFM90-SD1305-D050-A22-Z04-H	●	50	4	22	40	13	SD.. 1305..	1020-M5x11	80-T20	2408-M10x30
AFM90-SD1305-D063-A22-Z05-H	●	63	5	22	50	13				2508-M10x30
AFM90-SD1305-D080-A27-Z06-H	●	80	6	27	50	13				2510-M12x35
AFM90-SD1305-D100-A32-Z07-H	●	100	7	32	50	13				2514-M16x35
AFM90-SD1305-D125-B40-Z08	●	125	8	40	63	13				-
AFM90-SD1305-D160-C40-Z10	●	160	10	40	63	13				-

R: Sağ / Right / Rechts L: Sol / Left / Links

● Stokta / In Stock / Auf Lager ○ Stokta Yok / Non Stock Item / Kein Lagerartikel, Lieferzeit auf Anfrage

KRLY Ucuna Uygunudur. / Compatible with KRLY Insert. / Kompatibel mit KRLY Wendepalten.

Sipariş Örneği/Ordering Example/Bestellbeispiel

1 ad./pcs./stück AFM90S-SD1204-D050-A22-Z04-H

Kesme Hesabı : S 377 / Cutting Calculation : P 377 / Schnittberechnung : P 377

Montaj Ölçüleri : S 374 / Mounting Reference : P 374 / Montagehinweis : P 374

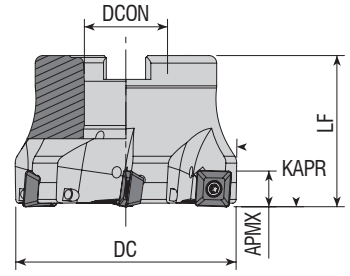

Takım Kodu Ordering Code Bestell-Bezeichnung	Stok Stock Lager	Takım Ölçüleri (mm) Dimension (mm) Abmessung (mm)					Kesici Uç Insert Wendeschneidplatte	Yedek Parçaları / Spare Parts / Ersatzteile			
		DC	ZEFP	DCON	LF	APMX		Sıkma Vidası Screw Schraube	Tork Anahtar Torx Key Torx-Schlüssel	Montaj Vidası Mounting Screw Befestigungsschraube	
AFM90-SE09-D040-A16-Z04-H	●	40	4	16	40	6.7	SEET 09T3..	3008-M3x8	82-T08	2506-M8x30	
AFM90-SE09-D050-A22-Z05-H	●	50	5	22	40	6.7				2508-M10x30	
AFM90-SE09-D063-A22-Z06-H	●	63	6	22	40	6.7				-	

ZCC Ucuna Uygundur. / Compatible with ZCC Insert. / Kompatibel mit ZCC Wendeplatten.

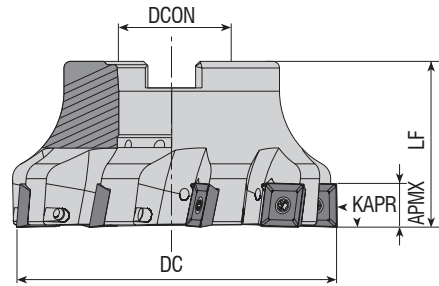

Takım Kodu Ordering Code Bestell-Bezeichnung	Stok Stock Lager	Takım Ölçüleri (mm) Dimension (mm) Abmessung (mm)					Kesici Uç Insert Wendeschneidplatte	Yedek Parçaları / Spare Parts / Ersatzteile			
		DC	ZEFP	DCON	LF	APMX		Sıkma Vidası Screw Schraube	Tork Anahtar Torx Key Torx-Schlüssel	Montaj Vidası Mounting Screw Befestigungsschraube	
AFM90-SE12-D050-A22-Z04-H	●	50	4	22	40	12	SEET 1203..	4015-M3.5x11	80-T15	2508-M10x30	
AFM90-SE12-D063-A22-Z05-H	●	63	5	22	40	12				2510-M12x35	
AFM90-SE12-D080-A27-Z07-H	●	80	7	27	50	12				2514-M16x35	
AFM90-SE12-D100-A32-Z09-H	●	100	9	32	50	12				-	
AFM90-SE12-D125-B40-Z11	●	125	11	40	63	12				-	



R: Sağ / Right / Rechts L: Sol / Left / Links

● Stokta / In Stock / Auf Lager ○ Stokta Yok / Non Stock Item / Kein Lagerartikel, Lieferzeit auf Anfrage

ZCC Ucuna Uygundur. / Compatible with ZCC Insert. / Kompatibel mit ZCC Wendeplatten.

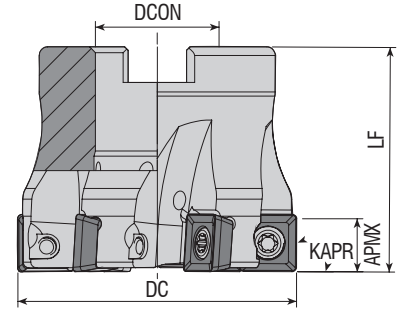

Sipariş Örneği/Ordering Example/Bestellbeispiel  
1 ad./pcs./stück AFM90-SE09-D040-A16-Z04-H

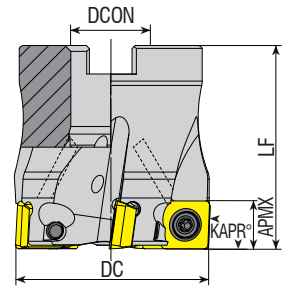

Takım Kodu Ordering Code Bestell-Bezeichnung	Stok Stock Lager	Takım Ölçüleri (mm) Dimension (mm) Abmessung (mm)					Kesici Uç Insert Wendeschneidplatte	Yedek Parçaları / Spare Parts / Ersatzteile		
		DC	ZEFP	DCON	LF	APMX		Sıkma Vidası Screw Schraube	Tork Anahtar Torx Key Torx-Schlüssel	Montaj Vidası Mounting Screw Befestigungsschraube
AFM90-SP1004-D040-A16-Z04-H	●	40	4	16	40	9.4	 <b>SPMT 1004..</b> <b>XPMT 1004..</b> <b>QPMR 1004..</b> <b>QPMT 1004..</b>	 4015-M4x10	 80-T15	2506-M8x30
AFM90-SP1004-D050-A22-Z04-H	●	50	4	22	40	9.4				2508-M10x30
AFM90-SP1004-D050-A22-Z06-H	●	50	6	22	40	9.4				2510-M12x35
AFM90-SP1004-D063-A22-Z05-H	●	63	5	22	40	9.4				2514-M16x35
AFM90-SP1004-D080-A27-Z07-H	●	80	7	27	50	9.4				
AFM90-SP1004-D100-A32-Z08-H	●	100	8	32	50	9.4				

ISCR Ucuna Uygundur. / Compatible with ISCR Insert. / Kompatibel mit ISCR Wendepfetten.



Takım Kodu Ordering Code Bestell-Bezeichnung	Stok Stock Lager	Takım Ölçüleri (mm) Dimension (mm) Abmessung (mm)					Kesici Uç Insert Wendeschneidplatte	Yedek Parçaları / Spare Parts / Ersatzteile		
		DC	ZEFP	DCON	LF	APMX		Sıkma Vidası Screw Schraube	Tork Anahtar Torx Key Torx-Schlüssel	Montaj Vidası Mounting Screw Befestigungsschraube
AFM90-SP09T3-D040-A16-Z05-H	●	40	5	16	40	8.6	 <b>SPMT 09T3..</b>	 3010-M3.5x9	 82-T10	2506-M8x30
AFM90-SP09T3-D050-A22-Z06-H	●	50	6	22	40	8.6				2508-M10x30
AFM90-SP09T3-D063-A22-Z07-H	●	63	7	22	40	8.6				2510-M12x35
AFM90-SP09T3-D080-A27-Z08-H	●	80	8	27	50	8.6				

R: Sağ / Right / Rechts L: Sol / Left / Links

● Stokta / In Stock / Auf Lager ○ Stokta Yok / Non Stock Item / Kein Lagerartikel, Lieferzeit auf Anfrage

SNDVK Ucuna Uygundur. / Compatible with SNDVK Insert. / Kompatibel mit SNDVK Wendepfetten.

Sipariş Örneği/Ordering Example/Bestellbeispiel

1 ad./pcs./stück AFM90-SP1004-D040-A16-Z04-H

Kesme Hesabı : S 377 / Cutting Calculation : P 377 / Schnittberechnung : P 377

Montaj Ölçüleri : S 374 / Mounting Reference : P 374 / Montagehinweis : P374



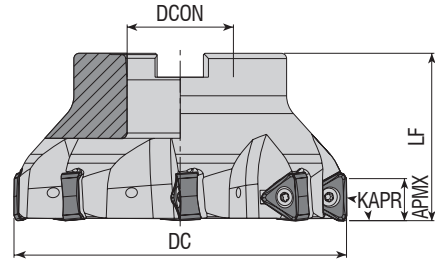
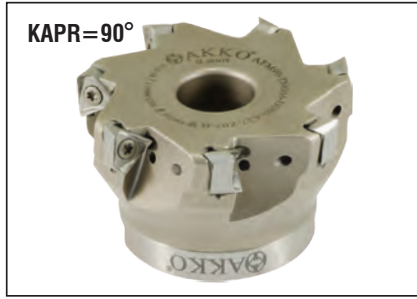

Takım Kodu Ordering Code Bestell-Bezeichnung	Stok Stock Lager	Takım Ölçüleri (mm) Dimension (mm) Abmessung (mm)					Kesici Uç Insert Wendeschneidplatte	Yedek Parçaları / Spare Parts / Ersatzteile		
		DC	ZEFP	DCON	LF	APMX		Sıkma Vidası Screw Schraube	Tork Anahtar Torx Key Torx-Schlüssel	Montaj Vidası Mounting Screw Befestigungsschraube
AFM90-TNG10-D040-A16-Z04-H	●	40	4	16	40	5	TNGX 1004..	3008-M2.5x6	82-T08	2506-M8x30
AFM90-TNG10-D040-A16-Z06-H	○	40	6	16	40	5				2508-M10X30
AFM90-TNG10-D050-A22-Z05-H	○	50	5	22	40	5				2510-M12X35
AFM90-TNG10-D050-A22-Z07-H	○	50	7	22	40	5				
AFM90-TNG10-D063-A22-Z06-H	○	63	6	22	40	5				
AFM90-TNG10-D063-A22-Z09-H	○	63	9	22	40	5				
AFM90-TNG10-D080-A27-Z10-H	○	80	10	27	50	5				
AFM90-TNG16-D040-A16-Z03-H	○	40	3	16	40	10	TNGX 1606..	3015-M4x11	80-T15	2406-M8X30
AFM90-TNG16-D040-A16-Z04-H	○	40	4	16	40	10				2508-M10X30
AFM90-TNG16-D050-A22-Z04-H	○	50	4	22	40	10				2510-M12X35
AFM90-TNG16-D050-A22-Z05-H	○	50	5	22	40	10				
AFM90-TNG16-D063-A22-Z04-H	○	63	4	22	40	10				
AFM90-TNG16-D063-A22-Z06-H	○	63	6	22	40	10				
AFM90-TNG16-D080-A27-Z05-H	○	80	5	27	50	10				
AFM90-TNG16-D080-A27-Z07-H	●	80	7	27	50	10				
AFM90-TNG16-D100-A32-Z06-H	○	100	6	32	50	10				
AFM90-TNG16-D100-A32-Z08-H	○	100	8	32	50	10				
AFM90-TNG16-D115-A32-Z06-H	○	115	6	32	50	10				
AFM90-TNG16-D125-A40-Z07-H	○	125	7	40	63	10				
AFM90-TNG16-D125-A40-Z09-H	○	125	9	40	63	10				
AFM90-TNG16-D140-B40-Z08-H	○	140	8	40	63	10				
AFM90-TNG16-D160-C40-Z10-H	○	160	10	40	63	10				
AFM90-TNG16-D175-C40-Z10-H	○	175	10	40	63	10				

R: Sağ / Right / Rechts L: Sol / Left / Links

● Stokta / In Stock / Auf Lager ○ Stokta Yok / Non Stock Item / Kein Lagerartikel, Lieferzeit auf Anfrage

PRMT Ucuna Uygundur. / Compatible with PRMT Insert. / Kompatibel mit PRMT Wendeplatten.

Sipariş Örneği/Ordering Example/Bestellbeispiel  
1 ad./pcs./stück AFM90-TNG10-D040-A16-Z04-H

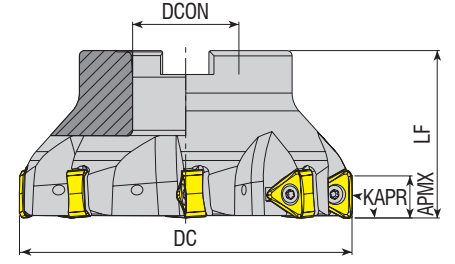

Takım Kodu Ordering Code Bestell-Bezeichnung	Stok Stock Lager	Takım Ölçüleri (mm) Dimension (mm) Abmessung (mm)					Kesici Uç Insert Wendeschneidplatte	Yedek Parçaları / Spare Parts / Ersatzteile		
		DC	ZEFP	DCON	LF	APMX		Sıkma Vidası Screw Schraube	Tork Anahtar Torx Key Torx-Schlüssel	Montaj Vidası Mounting Screw Befestigungsschraube
AFM90-TN2207-D063-A22-Z04-H	●	63	4	22	40	15	TN.X 2207..	1120-M4.5x12	80-T20	2508-M10x30
AFM90-TN2207-D080-A27-Z05-H	●	80	5	27	50	15				2510-M12x35
AFM90-TN2207-D100-B32-Z06	●	100	6	32	50	15				2514-M16x35
AFM90-TN2207-D125-B40-Z08	●	125	8	40	63	15				-

TGTC Ucuna Uygunur. / Compatible with TGTC Insert. / Kompatibel mit TGTC Wendeplatten.

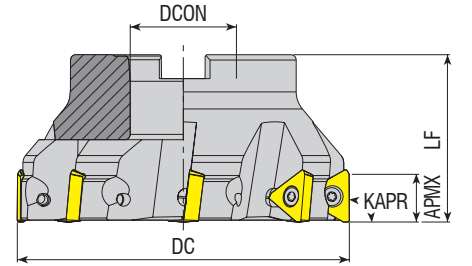

Takım Kodu Ordering Code Bestell-Bezeichnung	Stok Stock Lager	Takım Ölçüleri (mm) Dimension (mm) Abmessung (mm)					Kesici Uç Insert Wendeschneidplatte	Yedek Parçaları / Spare Parts / Ersatzteile		
		DC	ZEFP	DCON	LF	APMX		Sıkma Vidası Screw Schraube	Tork Anahtar Torx Key Torx-Schlüssel	Montaj Vidası Mounting Screw Befestigungsschraube
AFM90-TP2205-D063-A22-Z04	●	63	4	22	40	18	TPKT 2205..	1120-M4.5x12	80-T20	2508-M10x30
AFM90-TP2205-D080-A27-Z06	●	80	6	27	50	18				2510-M12x35
AFM90-TP2205-D100-A32-Z07	●	100	7	32	50	18				2514-M16x35
AFM90-TP2205-D125-B40-Z08	●	125	8	40	63	18				-
AFM90-TP2205-D160-C40-Z09	●	160	9	40	63	18				-
AFM90-TP2205-D200-C60-Z12	●	200	12	60	63	18				-

R: Sağ / Right / Rechts L: Sol / Left / Links

● Stokta / In Stock / Auf Lager ○ Stokta Yok / Non Stock Item / Kein Lagerartikel, Lieferzeit auf Anfrage  
TGTC Ucuna Uygunur. / Compatible with TGTC Insert. / Kompatibel mit TGTC Wendeplatten.

Sipariş Örneği/Ordering Example/Bestellbeispiel

1 ad./pcs./stück AFM90-TN2207-D063-A22-Z04-H

Kesme Hesabı : S 377 / Cutting Calculation : P 377 / Schnittberechnung : P 377

Montaj Ölçüleri : S 374 / Mounting Reference : P 374 / Montagehinweis : P 374

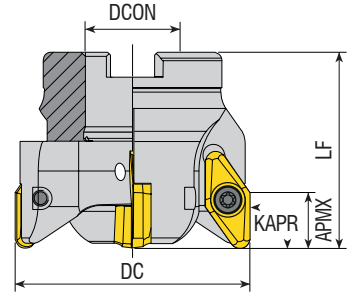

Takım Kodu Ordering Code Bestell-Bezeichnung	Stok Stock Lager	Takım Ölçüleri (mm) Dimension (mm) Abmessung (mm)					Kesici Uç Insert Wendeschneidplatte	Yedek Parçaları / Spare Parts / Ersatzteile			
		DC	ZEFP	DCON	LF	APMX		Sıkma Vidası Screw Schraube	Tork Anahtar Torx Key Torx-Schlüssel	Montaj Vidası Mounting Screw Befestigungsschraube	
AFM90-VC2205-D050-A22-Z03-H	●	50	3	22	55	15	VCKT 2205..				2508-M10x30
AFM90-VC2205-D063-A22-Z04-H	●	63	4	22	55	15					
AFM90-VC2205-D066-A27-Z04-H	●	66	4	27	55	15					
AFM90-VC2205-D080-A27-Z05-H	●	80	5	27	60	15					

ISO Ucuna Uygundur. / Compatible with ISO Insert. / Kompatibel mit ISO Wendeplatten.

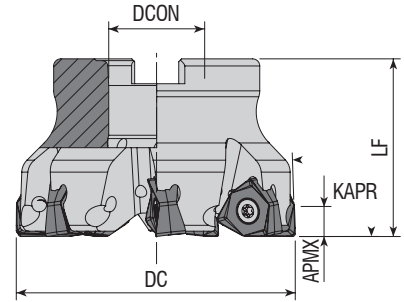
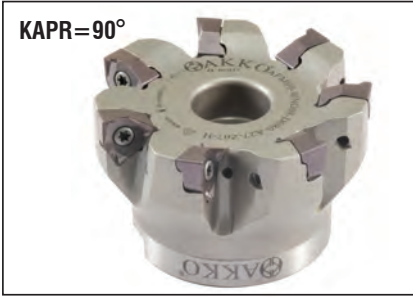

Takım Kodu Ordering Code Bestell-Bezeichnung	Stok Stock Lager	Takım Ölçüleri (mm) Dimension (mm) Abmessung (mm)					Kesici Uç Insert Wendeschneidplatte	Yedek Parçaları / Spare Parts / Ersatzteile			
		DC	ZEFP	DCON	LF	APMX		Sıkma Vidası Screw Schraube	Tork Anahtar Torx Key Torx-Schlüssel	Montaj Vidası Mounting Screw Befestigungsschraube	
AFM90-WNG04-D040-A16-Z06-H	●	40	6	16	40	4	WNGU 0403..				2506-M8x30
AFM90-WNG04-D050-A22-Z05-H	●	50	5	22	40	4					
AFM90-WNG04-D050-A22-Z07-H	●	50	7	22	40	4					
AFM90-WNG04-D063-A22-Z06-H	●	63	6	22	40	4					
AFM90-WNG08-D050-A22-Z05-H	●	50	5	22	40	7.5	WNGU 0806..				2510-M12x35
AFM90-WNG08-D063-A22-Z06-H	●	63	6	22	40	7.5					
AFM90-WNG08-D080-A27-Z07-H	●	80	7	27	50	7.5					
<b>new</b> AFM90-WNG08-D100-A32-Z07-H	●	100	10	32	50	7.5					

R: Sağ / Right / Rechts L: Sol / Left / Links

● Stokta / In Stock / Auf Lager ○ Stokta Yok / Non Stock Item / Kein Lagerartikel, Lieferzeit auf Anfrage

XTC-GSC Ucuna Uygundur. / Compatible with XTC-GSC Insert. / Kompatibel mit XTC-GSC Wendeplatten.

Sipariş Örneği/Ordering Example/Bestellbeispiel

1 ad./pcs./stück AFM90-VC2205-D050-A22-Z03-H

Kesme Hesabı : S 377 / Cutting Calculation : P 377 / Schnittberechnung : P 377

Montaj Ölçüleri : S 374 / Mounting Reference : P 374 / Montagehinweis : P374

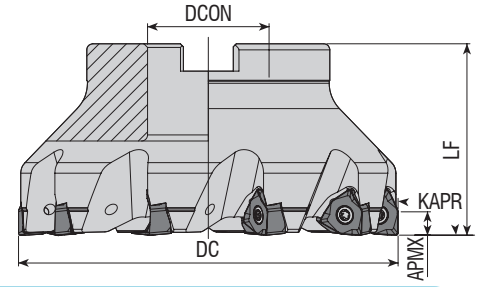

Takım Kodu Ordering Code Bestell-Bezeichnung	Stok Stock Lager	Takım Ölçüleri (mm) Dimension (mm) Abmessung (mm)					Kesici Uç Insert Wendeschneidplatte	Yedek Parçaları / Spare Parts / Ersatzteile		
		DC	ZEFP	DCON	LF	APMX		Sıkma Vidası Screw Schraube	Tork Anahtar Torx Key Torx-Schlüssel	Montaj Vidası Mounting Screw Befestigungsschraube
AFM90-WN0604Z-D040-A16-Z04-H	●	40	4	16	40	5.7	WNHU 0604..	3008-M3x8	82-T08	2506-M8x30
AFM90-WN0604Z-D050-A22-Z05-H	●	50	5	22	40	5.7				2508-M10x30
AFM90-WN0604Z-D063-A22-Z06-H	●	63	6	22	40	5.7				2510-M12x35
AFM90-WN0604Z-D080-A27-Z07-H	●	80	7	27	50	5.7				2514-M16x35
AFM90-WN0604Z-D100-A32-Z09-H	●	100	9	32	50	5.7				-
AFM90-WN0806Z-D050-A22-Z04-H	●	50	4	22	40	7.7	WNHU 0806..	4015-M4x11	80-T15	2508-M10x30
AFM90-WN0806Z-D063-A22-Z05-H	●	63	5	22	40	7.7				2510-M12x35
AFM90-WN0806Z-D080-A27-Z06-H	●	80	6	27	50	7.7				2514-M16x35
AFM90-WN0806Z-D100-A32-Z08-H	●	100	8	32	50	7.7				-
AFM90-WN0806Z-D125-B40-Z10	●	125	10	40	63	7.7				-
AFM90-WN0806Z-D160-C40-Z12	●	160	12	40	63	7.7	-	-	-	

ZCC Ucuuna Uygundur. / Compatible with ZCC Insert. / Kompatibel mit ZCC Wendeplatten.

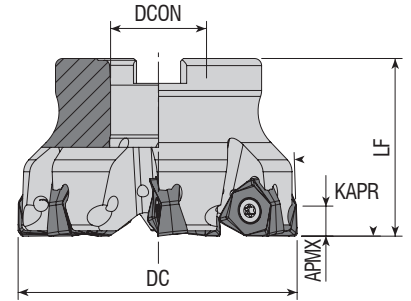

Takım Kodu Ordering Code Bestell-Bezeichnung	Stok Stock Lager	Takım Ölçüleri (mm) Dimension (mm) Abmessung (mm)					Kesici Uç Insert Wendeschneidplatte	Yedek Parçaları / Spare Parts / Ersatzteile		
		DC	ZEFP	DCON	LF	APMX		Sıkma Vidası Screw Schraube	Tork Anahtar Torx Key Torx-Schlüssel	Montaj Vidası Mounting Screw Befestigungsschraube
AFM90-WN0806-D050-A16-Z04-H	●	50	4	16	40	8	WNMX 080608	1615-M5x14	80-T15	2506-M8x30
AFM90-WN0806-D063-A22-Z05-H	●	63	5	22	40	8				2508-M10x30
AFM90-WN0806-D080-A27-Z07-H	●	80	7	27	50	8				2510-M12x35

R: Sağ / Right / Rechts L: Sol / Left / Links  
● Stokta / In Stock / Auf Lager ○ Stokta Yok / Non Stock Item / Kein Lagerartikel, Lieferzeit auf Anfrage  
KYCR-JD Ucuuna Uygundur. / Compatible with KYCR-JD Insert. / Kompatibel mit KYCR-JD Wendeplatten.

Sipariş Örneği/Ordering Example/Bestellbeispiel  
1 ad./pcs./stück AFM90-WN0604Z-D040-A16-Z04-H  
Kesme Hesabı : S 377 / Cutting Calculation : P 377 / Schnittberechnung : P 377  
Montaj Ölçüleri : S 374 / Mounting Reference : P 374 / Montagehinweis : P374

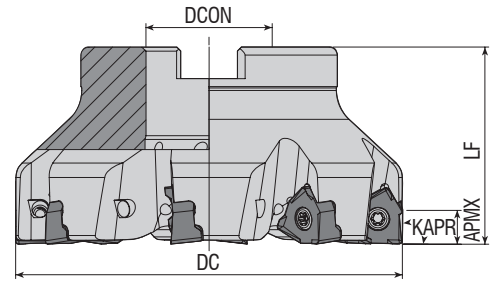

Takım Kodu Ordering Code Bestell-Bezeichnung	Stok Stock Lager	Takım Ölçüleri (mm) Dimension (mm) Abmessung (mm)					Kesici Uç Insert Wendeschneidplatte	Yedek Parçaları / Spare Parts / Ersatzteile		
		DC	ZEFP	DCON	LF	APMX		Sıkma Vidası Screw Schraube	Tork Anahtar Torx Key Torx-Schlüssel	Montaj Vidası Mounting Screw Befestigungsschraube
AFM90-XN0403-D040-A16-Z05-H	●	40	5	16	40	4				
AFM90-XN0806-D050-A22-Z04-H	●	50	4	22	40	7.5	XNEX 0806..	4015-M4x11	80-T15	2508-M10x30
AFM90-XN0806-D063-A22-Z05-H	●	63	5	22	40	7.5				2510-M12x35
AFM90-XN0806-D080-A27-Z07-H	●	80	7	27	50	7.5				2514-M16x35
AFM90-XN0806-D100-A32-Z08-H	●	100	8	32	50	7.5				

SC Ucuna Uygunur. / Compatible with SC Insert. / Kompatibel mit SC Wendepplatten.

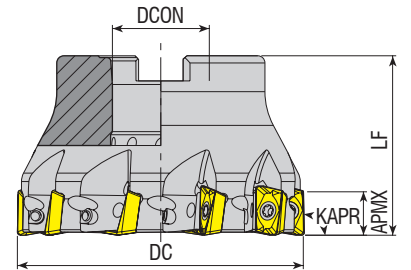

Takım Kodu Ordering Code Bestell-Bezeichnung	Stok Stock Lager	Takım Ölçüleri (mm) Dimension (mm) Abmessung (mm)					Kesici Uç Insert Wendeschneidplatte	Yedek Parçaları / Spare Parts / Ersatzteile		
		DC	ZEFP	DCON	LF	APMX		Sıkma Vidası Screw Schraube	Tork Anahtar Torx Key Torx-Schlüssel	Montaj Vidası Mounting Screw Befestigungsschraube
AFM90-X012-D040-A16-Z05-H	●	40	5	16	40	11				2506-M8x30
AFM90-X012-D050-A22-Z07-H	●	50	7	22	40	11				2508-M10x30
AFM90-X012-D063-A22-Z08-H	●	63	8	22	40	11				2510-M12x35
AFM90-X012-D080-A27-Z10-H	●	80	10	27	50	11				2514-M16x35
AFM90-X012-D100-A32-Z12-H	●	100	12	32	50	11				

R: Sağ / Right / Rechts L: Sol / Left / Links

● Stokta / In Stock / Auf Lager ○ Stokta Yok / Non Stock Item / Kein Lagerartikel, Lieferzeit auf Anfrage

SC Ucuna Uygunur. / Compatible with SC Insert. / Kompatibel mit SC Wendepplatten.

Sipariş Örneği/Ordering Example/Bestellbeispiel

1 ad./pcs./stück AFM90-XN0403-D040-A16-Z05-H

Kesme Hesabı : S 377 / Cutting Calculation : P 377 / Schnittberechnung : P 377

Montaj Ölçüleri : S 374 / Mounting Reference : P 374 / Montagehinweis : P 374

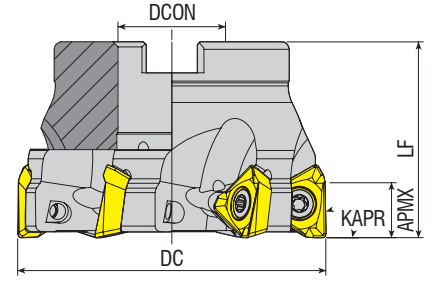

Takım Kodu Ordering Code Bestell-Bezeichnung	Stok Stock Lager	Takım Ölçüleri (mm) Dimension (mm) Abmessung (mm)					Kesici Uç Insert Wendeschneidplatte	Yedek Parçaları / Spare Parts / Ersatzteile		
		DC	ZEFP	DCON	LF	APMX		Sıkma Vidası Screw Schraube	Tork Anahtar Torx Key Torx-Schlüssel	Montaj Vidası Mounting Screw Befestigungsschraube
AFM90-3P1004-D040-A16-Z05-H	●	40	5	16	40	7	3PKT 1004..	1108-M2.5x6	82-T08	2506-M8x30
AFM90-3P1004-D050-A22-Z06-H	●	50	6	22	40	7				
AFM90-3P1505-D050-A22-Z04-H	●	50	4	22	40	11	3PKT 1505..	1115-M4x10	80-T15	2508-M10x30
AFM90-3P1505-D050-A22-Z05-H	●	50	5	22	40	11				
AFM90-3P1505-D063-A22-Z04-H	●	63	4	22	40	11				
AFM90-3P1505-D063-A22-Z06-H	●	63	6	22	40	11				
AFM90-3P1505-D080-A27-Z07-H	●	80	7	27	50	11				
AFM90-3P1505-D100-A32-Z08-H	●	100	8	32	50	11				
AFM90-3P1505-D125-B40-Z10	●	125	10	40	63	11	3PKT 1906..	1120-M4.5x12	80-T20	2514-M16x35
<b>new</b> AFM90-3P1906-D080-A27-Z07-H	●	80	7	27	50	15				
<b>new</b> AFM90-3P1906-D100-A32-Z08-H	●	100	8	32	50	15				
<b>new</b> AFM90-3P1906-D125-B40-Z10	●	125	10	40	63	15				

TGTC Ucuna Uygunudur. / Compatible with TGTC Insert. / Kompatibel mit TGTC Wendeplatten.

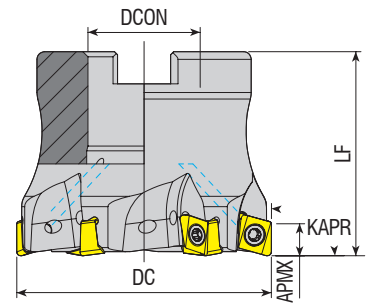

Takım Kodu Ordering Code Bestell-Bezeichnung	Stok Stock Lager	Takım Ölçüleri (mm) Dimension (mm) Abmessung (mm)					Kesici Uç Insert Wendeschneidplatte	Yedek Parçaları / Spare Parts / Ersatzteile		
		DC	ZEFP	DCON	LF	APMX		Sıkma Vidası Screw Schraube	Tork Anahtar Torx Key Torx-Schlüssel	Montaj Vidası Mounting Screw Befestigungsschraube
AFM90-4N06-D040-A16-Z05-H	●	40	5	16	40	6	4NKT 0603..	1108-M3x6.8	82-T08	2506-M8x30
AFM90-4N06-D050-A22-Z06-H	●	50	6	22	40	6				2508-M10x30

R: Sağ / Right / Rechts L: Sol / Left / Links

● Stokta / In Stock / Auf Lager ○ Stokta Yok / Non Stock Item / Kein Lagerartikel, Lieferzeit auf Anfrage  
TGTC Ucuna Uygunudur. / Compatible with TGTC Insert. / Kompatibel mit TGTC Wendeplatten.

Sipariş Örneği/Ordering Example/Bestellbeispiel

1 ad./pcs./stück AFM90-3P1004-D040-A16-Z05-H

Kesme Hesabı : S 377 / Cutting Calculation : P 377 / Schnittberechnung : P 377

Montaj Ölçüleri : S 374 / Mounting Reference : P 374 / Montagehinweis : P374



KAPR=90°

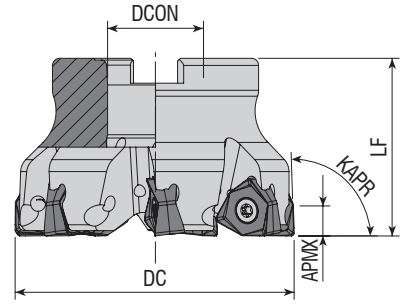

Takım Kodu Ordering Code Bestell-Bezeichnung	Stok Stock Lager	Takım Ölçüleri (mm) Dimension (mm) Abmessung (mm)					Kesici Uç Insert Wendeschneidplatte	Yedek Parçaları / Spare Parts / Ersatzteile		
		DC	ZEPF	DCON	LF	APMX		Sıkma Vidası Screw Schraube	Tork Anahtar Torx Key Torx-Schlüssel	Montaj Vidası Mounting Screw Befestigungsschraube
AFM90-6N09-D050-A22-Z05-H	○	50	5	22	40	9	6NGU 0905..	1115-M4x10	80-T15	2508-M10x30
AFM90-6N09-D063-A22-Z06-H	●	63	6	22	40	9				2510-M12x35
AFM90-6N09-D080-A27-Z07-H	○	80	7	27	50	9				2514-M16x35
AFM90-6N09-D100-A32-Z08-H	●	100	8	32	50	9				-
AFM90-6N14-D050-A22-Z04-H	○	50	4	22	50	8.2	6NMU 1409..	1120-M5x12	80-T20	2508-M10x30
AFM90-6N14-D063-A22-Z05-H	○	63	5	22	40	8.2				2510-M12x35
AFM90-6N14-D080-A27-Z07-H	○	80	7	27	50	8.2				2514-M16x35
AFM90-6N14-D100-A32-Z07-H	○	100	7	32	50	8.2				-
AFM90-6N14-D125-B40-Z08	○	125	8	40	63	8.2				-

R: Sağ / Right / Rechts L: Sol / Left / Links

● Stokta / In Stock / Auf Lager ○ Stokta Yok / Non Stock Item / Kein Lagerartikel, Lieferzeit auf Anfrage  
MTSBH Ucuna Uygundur. / Compatible with MTSBH Insert. / Kompatibel mit MTSBH Wendeplatten.

Sipariş Örneği/Ordering Example/Bestellbeispiel

1 ad./pcs./stück AFM90-6N09-D050-A22-Z05-H

Kesme Hesabı : S 377 / Cutting Calculation : P 377 / Schnittberechnung : P 377

Montaj Ölçüleri : S 374 / Mounting Reference : P 374 / Montagehinweis : P 374



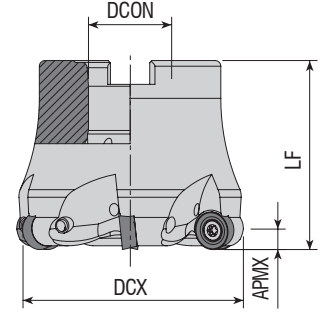

Takım Kodu Ordering Code Bestell-Bezeichnung	Stok Stock Lager	Takım Ölçüleri (mm) Dimension (mm) Abmessung (mm)					Kesici Uç Insert Wendeschneidplatte	Yedek Parçaları / Spare Parts / Ersatzteile		
		DCX	ZEFP	DCON	LF	APMX		Sıkma Vidası Screw Schraube	Tork Anahtar Torx Key Torx-Schlüssel	Montaj Vidası Mounting Screw Befestigungsschraube
AFMR-RC10T3-D040-A16-Z04-H	●	40	4	16	40	5	RC.. 10T3..	4015-M4x11	80-T15	2406-M8x30
AFMR-RC10T3-D050-A22-Z05-H	●	50	5	22	50	5				2508-M10x30
AFMR-RC10T3-D063-A22-Z06-H	●	63	6	22	50	5				

ZCC Ucuna Uygun. / Compatible with ZCC Insert. / Kompatibel mit ZCC Wendeplatten.

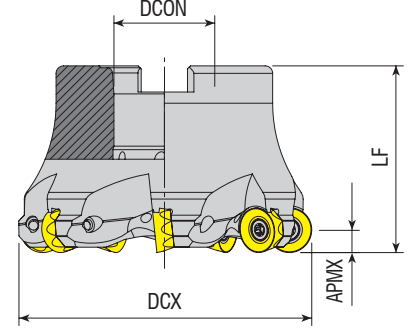

Takım Kodu Ordering Code Bestell-Bezeichnung	Stok Stock Lager	Takım Ölçüleri (mm) Dimension (mm) Abmessung (mm)					Kesici Uç Insert Wendeschneidplatte	Yedek Parçaları / Spare Parts / Ersatzteile		
		DCX	ZEFP	DCON	LF	APMX		Sıkma Vidası Screw Schraube	Tork Anahtar Torx Key Torx-Schlüssel	Montaj Vidası Mounting Screw Befestigungsschraube
AFMR-RC1204-D040-A16-Z04-H	●	40	4	16	40	6	RC.. 1204..	4015-M3.5x11	80-T15	2506-M8x30
AFMR-RC1204-D050-A22-Z05-H	●	50	5	22	50	6				2508-M10x30
AFMR-RC1204-D052-A22-Z05-H	●	52	5	22	50	6				
AFMR-RC1204-D063-A22-Z06-H	●	63	6	22	50	6				
AFMR-RC1204-D063-A27-Z06-H	●	80	6	27	50	6				
AFMR-RC1204-D080-A27-Z07-H	●	80	7	27	50	6				2510-M12x35

R: Sağ / Right / Rechts L: Sol / Left / Links

● Stokta / In Stock / Auf Lager ○ Stokta Yok / Non Stock Item / Kein Lagerartikel, Lieferzeit auf Anfrage  
SNDVK Ucuna Uygun. / Compatible with SNDVK Insert. / Kompatibel mit SNDVK Wendeplatten.

Sipariş Örneği/Ordering Example/Bestellbeispiel

1 ad./pcs./stück AFMR-RC10T3-D040-A16-Z04-H

Kesme Hesabı : S 377 / Cutting Calculation : P 377 / Schnittberechnung : P 377

Montaj Ölçüleri : S 374 / Mounting Reference : P 374 / Montagehinweis : P374



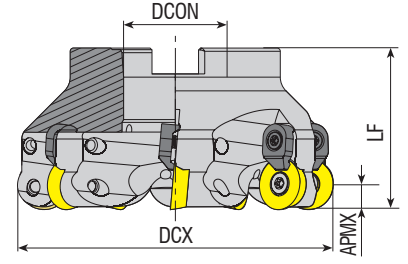

Takım Kodu Ordering Code Bestell-Bezeichnung	Stok Stock Lager	Takım Ölçüleri (mm) Dimension (mm) Abmessung (mm)					Kesici Uç Insert Wendeschneidplatte	Yedek Parçaları / Spare Parts / Ersatzteile								
		DCX	ZEPF	DCON	LF	APMX		Sıkma Vidası Screw Schraube	Baskı Parçası Wedge Clamp Spannpratze	Baskı Vidası Clamp Screw Klemmschraube	Tork Anahtar Torx Key Torx-Schlüssel	Montaj Vidası Mounting Screw Befestigungsschraube				
AFMR-RD0702-D050-A22-Z06-H	●	50	6	22	40	3.5	RD.. 0702	3008-M2.5x6	-	-	82-T08	2407-M10x30				
AFMR-RD0803-D050-A22-Z05-H	●	50	5	22	40	4	RD.. 0803	3008-M3x8	-	-	82-T08	2406-M8x30				
new AFMRC-RD1003-D040-A16-Z04-H	●	40	4	16	40	5	RD.. 1003	4015-M3.5x11	-	-	82-T08	2406-M8x30				
AFMR-RD1003-D040-A16-Z05-H	●	40	5	16	40	5						2508-M10x30				
AFMRC-RD1003-D050-A22-Z05-H	●	50	5	22	50	5						2510-M12X35				
AFMRC-RD1003-D052-A22-Z05	●	52	5	22	50	5						2514-M16x35				
AFMRC-RD1003-D063-A22-Z06-H	●	63	6	22	50	5						-				
new AFMRC-RD1003-D066-A27-Z07-H	●	66	7	27	50	5						-				
AFMRC-RD1003-D080-A27-Z07-H	●	80	7	27	50	5						-				
AFMRC-RD1003-D100-A32-Z08-H	●	100	8	32	50	5						-				
new AFMR-RD1004-D063-A22-Z06-H	●	63	6	22	50	50	RD.. 1004	4515-M4x8	-	-	-	-				
new AFMRC-RD10T3-D040-A16-Z05-H	●	40	5	16	40	5	RD.. 10T3	-	-	82-T08	2406-M8X30					
new AFMRC-RD10T3-D042-A16-Z05-H	●	42	5	16	40	5					-					
AFMRC-RD10T3-D050-A22-Z05-H	●	50	5	22	50	5					-					
AFMRC-RD10T3-D052-A22-Z05-H	●	52	5	22	40	5					-					
new AFMRC-RD10T3-D052-A22-Z06-H	●	52	6	22	40	5					-					
new AFMRC-RD10T3-D063-A22-Z06-H	●	63	6	22	50	5					-					
new AFMR-RD12T3-D066-A27-Z06-H	●	66	6	22	50	50					RD.. 12T3	4015-M3.5x9	ACK-15	4015-M3.5x11	80-T15	2406-M8X30
AFMRC-RD12T3-D040-A16-Z04-H	●	40	4	27	50	6										-
AFMRC-RD12T3-D050-A22-Z05-H	●	50	5	16	40	6	-									
AFMRC-RD12T3-D052-A22-Z05-H	●	52	5	22	50	6	-									
AFMRC-RD12T3-D063-A22-Z06-H	●	63	6	22	50	6	-									
AFMRC-RD12T3-D080-A27-Z07-H	●	80	7	22	50	6	-									
AFMRC-RD12T3-D100-A32-Z08-H	●	100	8	27	50	6	-									
AFMRC-RD12T3-D125-B40-Z09	●	125	9	32	50	6	-									
new AFMRC-RD1204-D040-A16-Z04-H	●	40	4	40	63	6	RD.. 1204	4015-M3.5x11	ACK-05	4015-M4x11	2406-M8X30					
new AFMRC-RD1204-D042-A16-Z04-H	●	42	4	16	40	6					-					
AFMRC-RD1204-D050-A22-Z05-H	●	50	5	16	40	6					-					
AFMRC-RD1204-D052-A22-Z05-H	●	52	5	22	50	6					-					
AFMRC-RD1204-D063-A22-Z06-H	●	63	6	22	50	6					-					
AFMRC-RD1204-D080-A27-Z07-H	●	80	7	22	50	6					-					
AFMRC-RD1204-D100-A32-Z07-H	●	100	7	27	50	6					-					
AFMRC-RD1204-D100-A32-Z08-H	●	100	8	32	50	6					-					
AFMRC-RD1604-D050-A22-Z04-H	●	50	4	32	50	6	RD.. 1604	4015-M4.5x11	ACK-05	4015-M4x11	2408-M10x30					
AFMRC-RD1604-D052-A22-Z04-H	●	52	4	22	50	8					-					
AFMRC-RD1604-D063-A22-Z05-H	●	63	5	22	50	8					-					
AFMRC-RD1604-D066-A22-Z05-H	●	66	5	22	50	8					-					
AFMRC-RD1604-D066-A27-Z05-H	●	66	5	22	50	8					-					
AFMRC-RD1604-D080-A27-Z06-H	●	80	6	27	50	8					-					
AFMRC-RD1604-D100-A32-Z07-H	●	100	7	27	50	8					-					
AFMRC-RD1604-D125-B40-Z07	●	125	7	32	50	8					-					
AFMRC-RD1604-D160-C40-Z08	●	160	8	40	63	8	-	-	-	-	-	-				

R: Sağ / Right / Rechts L: Sol / Left / Links

● Stokta / In Stock / Auf Lager ○ Stokta Yok / Non Stock Item / Kein Lagerartikel, Lieferzeit auf Anfrage  
ISO Ucuna Uygunudur. / Compatible with ISO Insert. / Kompatibel mit ISO Wendeplatten.

Sipariş Örneği/Ordering Example/Bestellbeispiel

1 ad./pcs./stück AFMR-RD0702-D050-A22-Z06-H

Kesme Hesabı : S 377 / Cutting Calculation : P 377 | Schnittberechnung : P 377

Montaj Ölçüleri : S 374 / Mounting Reference : P 374 | Montagehinweis : P374

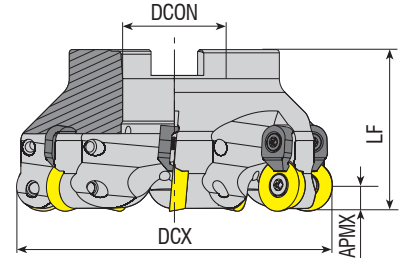

Takım Kodu Ordering Code Bestell-Bezeichnung	Stok Stock Lager	Takım Ölçüleri (mm) Dimension (mm) Abmessung (mm)					Kesici Uç Insert Wendeschneidplatte	Yedek Parçaları / Spare Parts / Ersatzteile				
		DC	ZEFP	DCON	LF	APMX		Sıkma Vidası Screw Schraube	Baskı Parçası Wedge Clamp Spannpratze	Baskı Vidası Clamp Screw Klemmschraube	Tork Anahtar Torx Key Torx-Schlüssel	Montaj Vidası Mounting Screw Befestigungsschraube
AFMRC-R020-D063-A22-Z05-H	●	63	5	22	50	10	ROMX 2006					
AFMRC-R020-D080-A27-Z06-H	●	80	6	27	50	10						

WLTR Ucuna Uygunur. / Compatible with WLTR Insert. / Kompatibel mit WLTR Wendeplatten.

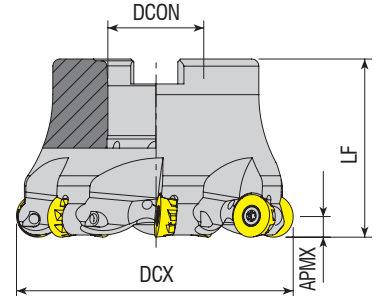

Takım Kodu Ordering Code Bestell-Bezeichnung	Stok Stock Lager	Takım Ölçüleri (mm) Dimension (mm) Abmessung (mm)					Kesici Uç Insert Wendeschneidplatte	Yedek Parçaları / Spare Parts / Ersatzteile		
		DCX	ZEFP	DCON	LF	APMX		Sıkma Vidası Screw Schraube	Tork Anahtar Torx Key Torx-Schlüssel	Montaj Vidası Mounting Screw Befestigungsschraube
AFMR-RP10T3-D063-A22-Z06-H	●	63	6	22	40	5	RPNX 10T3..			
AFMR-RP10T3-D080-A27-Z07-H	●	80	7	27	50	5				
AFMR-RP1204-D040-A16-Z04-H	●	40	4	16	40	6	RPNX 1204..			
AFMR-RP1204-D080-A27-Z07-H	●	80	7	27	50	6				

R: Sağ / Right / Rechts L: Sol / Left / Links

● Stokta / In Stock / Auf Lager ○ Stokta Yok / Non Stock Item / Kein Lagerartikel, Lieferzeit auf Anfrage  
CRTZT Ucuna Uygunur. / Compatible with CRTZT Insert. / Kompatibel mit CRTZT Wendeplatten.



Sipariş Örneği/Ordering Example/Bestellbeispiel

1 ad./pcs./stück AFMRC-R020-D063-A22-Z05-H

Kesme Hesabı : S 377 / Cutting Calculation : P 377 / Schnittberechnung : P 377

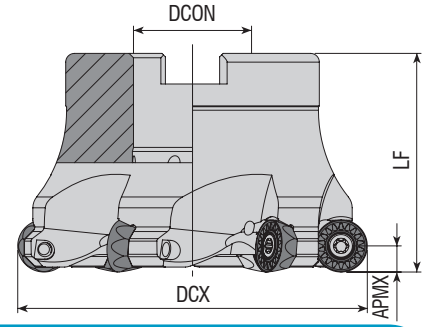



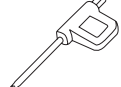

Montaj Ölçüleri : S 374 / Mounting Reference : P 374 / Montagehinweis : P 374

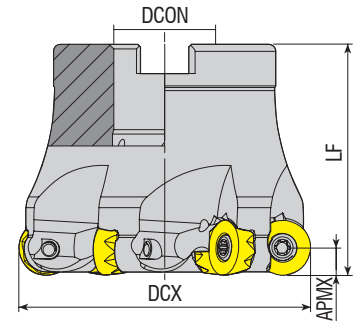

Takım Kodu Ordering Code Bestell-Bezeichnung	Stok Stock Lager	Takım Ölçüleri (mm) Dimension (mm) Abmessung (mm)					Kesici Uç Insert Wendeschneidplatte	Yedek Parçaları / Spare Parts / Ersatzteile		
		DCX	ZEFP	DCON	LF	APMX		Sıkma Vidası Screw Schraube	Tork Anahtar Torx Key Torx-Schlüssel	Montaj Vidası Mounting Screw Befestigungsschraube
<b>new</b> AFMR-RP1204M-D042-A16-Z04-H	●	42	4	16	40	6				2406-M8x30
AFMR-RP1204M-D050-A22-Z04-H	●	50	4	22	50	6				2508-M10x30
AFMR-RP1204M-D052-A22-Z05-H	●	52	5	22	50	6				2508-M10x30
AFMR-RP1204M-D063-A22-Z05-H	●	63	5	22	50	6				2508-M10x30
AFMR-RP1204M-D080-A27-Z06-H	●	80	6	27	50	6				2510-M12x35

MTSBH Ucuna Uygunur. / Compatible with MTSBH Insert. / Kompatibel mit MTSBH Wendeplatten.



Takım Kodu Ordering Code Bestell-Bezeichnung	Stok Stock Lager	Takım Ölçüleri (mm) Dimension (mm) Abmessung (mm)					Kesici Uç Insert Wendeschneidplatte	Yedek Parçaları / Spare Parts / Ersatzteile		
		DCX	ZEFP	DCON	LF	APMX		Sıkma Vidası Screw Schraube	Tork Anahtar Torx Key Torx-Schlüssel	Montaj Vidası Mounting Screw Befestigungsschraube
AFMR-RY10-D040-A16-Z04-H	●	40	4	16	40	5				2406-M8x30
AFMR-RY10-D040-A16-Z05-H	●	40	5	16	40	5				2506-M8x30
AFMR-RY10-D050-A22-Z05-H	●	50	5	22	50	5				2508-M10x30
AFMR-RY10-D063-A22-Z06-H	●	63	6	22	50	5				2508-M10x30
AFMR-RY12-D040-A16-Z04-H	●	40	4	16	40	6				2406-M8x30
AFMR-RY12-D050-A22-Z05-H	●	50	5	22	50	6				2508-M10x30
AFMR-RY12-D052-A22-Z05-H	●	52	5	22	50	6				2508-M10x30
AFMR-RY12-D063-A22-Z06-H	●	63	6	22	50	6				2508-M10x30
AFMR-RY12-D080-A27-Z06-H	●	80	6	27	50	6				2510-M12x35
AFMR-RY12-D100-A32-Z07-H	●	100	7	32	50	6				2514-M16x35

R: Sağ / Right / Rechts L: Sol / Left / Links

● Stokta / In Stock / Auf Lager ○ Stokta Yok / Non Stock Item / Kein Lagerartikel, Lieferzeit auf Anfrage

TGTC Ucuna Uygunur. / Compatible with TGTC Insert. / Kompatibel mit TGTC Wendeplatten.

Sipariş Örneği/Ordering Example/Bestellbeispiel

1 ad./pcs./stück AFMR-RP1204M-D042-A16-Z04-H

Kesme Hesabı : S 377 / Cutting Calculation : P 377 / Schnittberechnung : P 377

Montaj Ölçüleri : S 374 / Mounting Reference : P 374 / Montagehinweis : P374

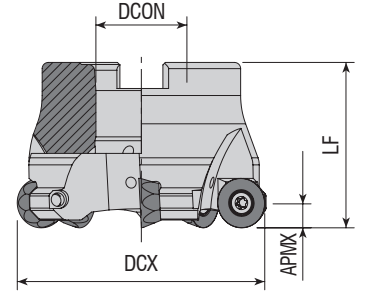

Takım Kodu Ordering Code Bestell-Bezeichnung	Stok Stock Lager	Takım Ölçüleri (mm) Dimension (mm) Abmessung (mm)					Kesici Uç Insert Wendeschneidplatte	Yedek Parçaları / Spare Parts / Ersatzteile			
		DCX	ZEFP	DCON	LF	APMX		Sıkma Vidası Screw Schraube	Tork Anahtar Torx Key Torx-Schlüssel	Montaj Vidası Mounting Screw Befestigungsschraube	
AFMR-QP10T3-D040-A16-Z04-H	●	40	4	16	40	5	QP. 10T3..	4015-M3.5x11	80-T15	2506-M8x30	
AFMR-QP10T3-D050-A22-Z05-H	●	50	5	22	40	5				2407-M10x30	
AFMR-QP10T3-D063-A22-Z06-H	●	63	6	22	40	5					
AFMR-QP1204-D050-A22-Z04-H	●	50	4	22	40	6	QP. 1204..	4015-M4x11			
AFMR-QP1204-D063-A22-Z05-H	●	63	5	22	40	6					

SMTM Ucuna Uygunur. / Compatible with SMTM Insert. / Kompatibel mit SMTM Wendeplatten.

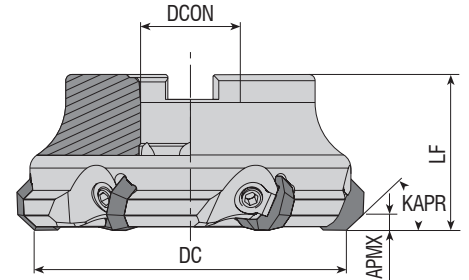

Takım Kodu Ordering Code Bestell-Bezeichnung	Stok Stock Lager	Takım Ölçüleri (mm) Dimension (mm) Abmessung (mm)					Kesici Uç Insert Wendeschneidplatte	Yedek Parçaları / Spare Parts / Ersatzteile			
		DC	ZEFP	DCON	LF	APMX		Baskı Parçası Wedge Clamp Spannpratze	Baskı Vidası Clamp Screw Klemmschraube	Anahtar Allen Key Innensechskantschlüssel	Montaj Vidası Mounting Screw Befestigungsschraube
AFM43C-OF07-D063-A22-Z04	●	63	4	22	45	5	OF. 0704..	ACK-11	AKV-15-M8x1x20	AAL-05-4	2508-M10x30
AFM43C-OF07-D080-A27-Z05	●	80	5	27	50	5					2510-M12x35
AFM43C-OF07-D100-A32-Z06	●	100	6	32	50	5					2514-M16x35
AFM43C-OF07-D125-B40-Z08	●	125	8	40	63	5					
AFM43C-OF07-D160-C40-Z09	●	160	9	40	63	5					

R: Sağ / Right / Rechts L: Sol / Left / Links

● Stokta / In Stock / Auf Lager ○ Stokta Yok / Non Stock Item / Kein Lagerartikel, Lieferzeit auf Anfrage  
ISO Ucuna Uygunur. / Compatible with ISO Insert. / Kompatibel mit ISO Wendeplatten.

Sipariş Örneği/Ordering Example/Bestellbeispiel

1 ad./pcs./stück AFMR-QP10T3-D040-A16-Z04-H

Kesme Hesabı : S 377 / Cutting Calculation : P 377 / Schnittberechnung : P 377

Montaj Ölçüleri : S 374 / Mounting Reference : P 374 / Montagehinweis : P374

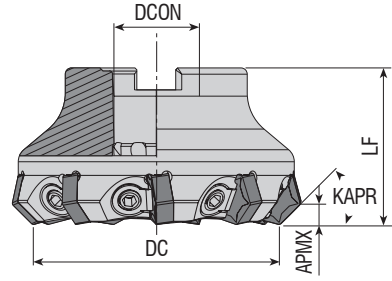

Takım Kodu Ordering Code Bestell-Bezeichnung	Stok Stock Lager	Takım Ölçüleri (mm) Dimension (mm) Abmessung (mm)					Kesici Uç Insert Wendeschneidplatte	Yedek Parçaları / Spare Parts / Ersatzteile			
		DC	ZEFP	DCON	LF	APMX		Baskı Parçası Wedge Clamp Spannpratze	Baskı Vidası Clamp Screw Klemmschraube	Anahtar Allen Key Innensechskantschlüssel	Montaj Vidası Mounting Screw Befestigungsschraube
AFM45C-HN0905-D063-A22-Z07	●	63	7	22	40	4.5	HN.. 0905..	ACK-11	AKV-15-M8x1x20	AAL-05-4	2508-M10x30
AFM45C-HN0905-D080-A27-Z09	●	80	9	27	50	4.5					2510-M12x35
AFM45C-HN0905-D100-A32-Z11	●	100	11	32	50	4.5					2514-M16x35
AFM45C-HN0905-D125-B40-Z13	●	125	13	40	63	4.5					-
AFM45CL-HN0905-D125-B40-Z10	●	125	10	40	63	4.5					-
AFM45C-HN0905-D160-C40-Z15	●	160	15	40	63	4.5					-

WDA-KNMTL Ucuna Uygunur. / Compatible with WDA-KNMTL Insert. / Kompatibel mit WDA-KNMTL Wendeplatten.

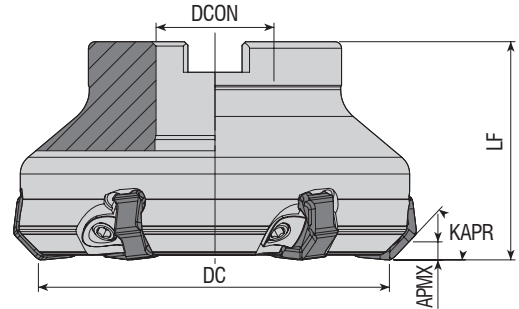

Takım Kodu Ordering Code Bestell-Bezeichnung	Stok Stock Lager	Takım Ölçüleri (mm) Dimension (mm) Abmessung (mm)					Kesici Uç Insert Wendeschneidplatte	Yedek Parçaları / Spare Parts / Ersatzteile			
		DC	ZEFP	DCON	LF	APMX		Baskı Parçası Wedge Clamp Spannpratze	Baskı Vidası Clamp Screw Klemmschraube	Anahtar Allen Key Innensechskantschlüssel	Montaj Vidası Mounting Screw Befestigungsschraube
AFM45C-XN0806-D063-A22-Z05	●	63	5	22	50	4.5	XN0806..	ACK-26	AKV-26-M6x0.75x20	AAL-03-03	2508-M10x30
AFM45C-XN0806-D080-A27-Z06	●	80	6	27	50	4.5					2510-M12x35
AFM45C-XN0806-D100-A32-Z08	●	100	8	32	50	4.5					2514-M16x35
AFM45C-XN0806-D125-B40-Z08	●	125	8	40	63	4.5					-
AFM45C-XN0806-D160-C40-Z10	●	160	10	40	63	4.5					-
AFM45C-XN0806-D200-C60-Z12	●	200	12	60	63	4.5					-

R: Sağ / Right / Rechts L: Sol / Left / Links

● Stokta / In Stock / Auf Lager ○ Stokta Yok / Non Stock Item / Kein Lagerartikel, Lieferzeit auf Anfrage  
DJT Ucuna Uygunur. / Compatible with DJT Insert. / Kompatibel mit DJT Wendeplatten.

Sipariş Örneği/Ordering Example/Bestellbeispiel

1 ad./pcs./stück AFM45C-HN0905-D063-A22-Z07

Kesme Hesabı : S 377 / Cutting Calculation : P 377 / Schnittberechnung : P 377

Montaj Ölçüleri : S 374 / Mounting Reference : P 374 / Montagehinweis : P374

KAPR=75°

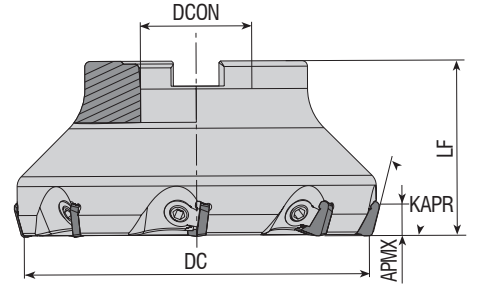

Takım Kodu Ordering Code Bestell-Bezeichnung	Stok Stock Lager	Takım Ölçüleri (mm) Dimension (mm) Abmessung (mm)					Kesici Uç Insert Wendeschneidplatte	Yedek Parçaları / Spare Parts / Ersatzteile			
		DC	ZEP	DCON	LF	APMX		Baskı Parçası Wedge Clamp Spannpratze	Baskı Vidası Clamp Screw Klemmschraube	Anahtar Allen Key Innensechskantschlüssel	Montaj Vidası Mounting Screw Befestigungsschraube
AFM75C-SP12-D050-A22-Z04	●	50	4	22	42	8	SPKN 1203..	ACK-10	AKV-22-M8x1x14	AAL-05-4	2508-M10x30
AFM75C-SP12-D063-A22-Z05	●	63	5	22	40	8					2510-M12x35
AFM75C-SP12-D080-A27-Z06	●	80	6	27	50	8					2514-M16x35
AFM75C-SP12-D100-A32-Z07	●	100	7	32	50	8					-
AFM75C-SP12-D125-B40-Z08	●	125	8	40	63	8					-
AFM75C-SP12-D160-C40-Z09	●	160	9	40	63	8					-
AFM75C-SP12-D200-C60-Z12	●	200	12	60	63	8					-

ISO Ucuna Uygundur. / Compatible with ISO Insert. / Kompatibel mit ISO Wendepfatten.

KAPR=88°

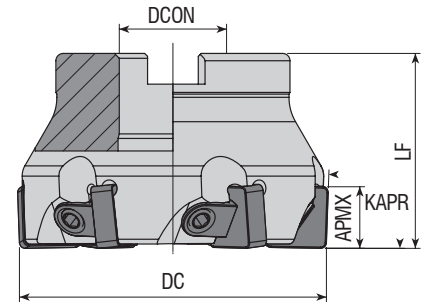

Takım Kodu Ordering Code Bestell-Bezeichnung	Stok Stock Lager	Takım Ölçüleri (mm) Dimension (mm) Abmessung (mm)					Kesici Uç Insert Wendeschneidplatte	Yedek Parçaları / Spare Parts / Ersatzteile			
		DC	ZEP	DCON	LF	APMX		Baskı Parçası Wedge Clamp Spannpratze	Baskı Vidası Clamp Screw Klemmschraube	Anahtar Allen Key Innensechskantschlüssel	Montaj Vidası Mounting Screw Befestigungsschraube
AFM88C-SN1204-D050-A22-Z05	●	50	5	22	40	11	SN.. 1204..	ACK-21	AKV-24-M6x1x18	AAL-03-3	2408-M10x30
AFM88C-SN1204-D063-A22-Z06	●	63	6	22	40	11					2510-M12x35
AFM88C-SN1204-D080-A27-Z07	●	80	7	27	50	11					2514-M16x35
AFM88C-SN1204-D100-A32-Z08	●	100	8	32	50	11					-
AFM88C-SN1204-D125-B40-Z11	●	125	11	40	63	11					-

R: Sağ / Right / Rechts L: Sol / Left / Links

● Stokta / In Stock / Auf Lager ○ Stokta Yok / Non Stock Item / Kein Lagerartikel, Lieferzeit auf Anfrage

UNIN-NT-KYCR Ucuna Uygundur. / Compatible with UNIN-NT-KYCR Insert. / Kompatibel mit UNIN-NT-KYCR Wendepfatten.

Sipariş Örneği/Ordering Example/Bestellbeispiel  
1 ad./pcs./stück AFM75C-SP12-D050-A22-Z04

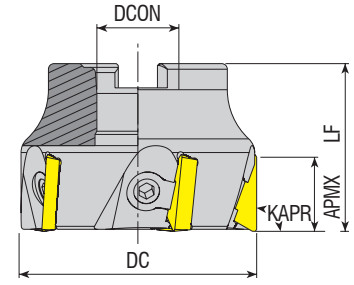

Takım Kodu Ordering Code Bestell-Bezeichnung	Stok Stock Lager	Takım Ölçüleri (mm) Dimension (mm) Abmessung (mm)					Kesici Uç Insert Wendeschneidplatte	Yedek Parçaları / Spare Parts / Ersatzteile			
		DC	ZEFP	DCON	LF	APMX		Baskı Parçası Wedge Clamp Spannpratze	Baskı Vidası Clamp Screw Klemmschraube	Anahtar Allen Key Innensechskantschlüssel	Montaj Vidası Mounting Screw Befestigungsschraube
AFM90C-TP16-D050-A22-Z04	●	50	4	22	40	12	TP. 1603..	ACK-10	AKV-22-M8x1x14 AKV-13-M8x1x16	AAL-05-4	2407-M10x30 2508-M10x30 2510-M12x35 2514-M16x35 -
AFM90C-TP16-D063-A22-Z06	●	63	6	22	45	12					
AFM90C-TP16-D080-A27-Z07	●	80	7	27	50	12					
AFM90C-TP16-D100-A32-Z08	●	100	8	32	50	12					
AFM90C-TP16-D125-B40-Z08	●	125	8	40	63	12					
AFM90C-TP22-D063-A22-Z05	●	63	5	22	45	18	TP. 2204..	ACK-11	AKV-14-M8x1x18	2508-M10x30 2510-M12x35 2514-M16x35 -	
AFM90C-TP22-D080-A27-Z06	●	80	6	27	50	18					
AFM90C-TP22-D100-A32-Z07	●	100	7	32	50	18					
AFM90C-TP22-D125-B40-Z08	●	125	8	40	63	18					
AFM90C-TP22-D160-C40-Z09	●	160	9	40	63	18					
AFM90C-TP22-D200-C60-Z12	●	200	12	60	63	18					
AFM90C-TP22-D250-C60-Z15	●	250	15	60	63	18					
AFM90C-TP22-D315-D60-Z18	●	315	18	60	63	18					

ISO Ucuna Uygundur. / Compatible with ISO Insert. / Kompatibel mit ISO Wendepfatten.

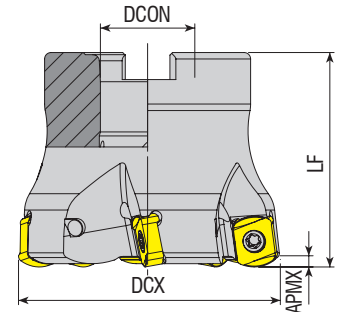

Takım Kodu Ordering Code Bestell-Bezeichnung	Stok Stock Lager	Takım Ölçüleri (mm) Dimension (mm) Abmessung (mm)					Kesici Uç Insert Wendeschneidplatte	Yedek Parçaları / Spare Parts / Ersatzteile		
		DCX	ZEFP	DCON	LF	APMX		Sıkma Vidası Screw Schraube	Tork Anahtar Torx Key Torx-Schlüssel	Montaj Vidası Mounting Screw Befestigungsschraube
AHFM-BL0603-D040-A16-Z06-H	●	40	6	16	40	1	BLMP 0603..	3008-M2.5x6	82-T08	2506-M8x30
AHFM-BL0603-D050-A22-Z07-H	●	50	7	22	40	1				
AHFM-BL0904-D040-A16-Z05-H	●	40	5	16	40	2	BLMP 0904..	3010-M3.5x9	82-T10	2508-M10x30
AHFM-BL0904-D050-A22-Z06-H	●	50	6	22	50	2				
AHFM-BL0904-D063-A22-Z05-H	●	63	5	22	50	2				
AHFM-BL0904-D063-A22-Z07-H	●	63	7	22	50	2				

R: Sağ / Right / Rechts L: Sol / Left / Links

● Stokta / In Stock / Auf Lager ○ Stokta Yok / Non Stock Item / Kein Lagerartikel, Lieferzeit auf Anfrage  
TGTC Ucuna Uygundur. / Compatible with TGTC Insert. / Kompatibel mit TGTC Wendepfatten.

Sipariş Örneği/Ordering Example/Bestellbeispiel

1 ad./pcs./stück AFM90C-TP16-D050-A22-Z04

Kesme Hesabı : S 377 / Cutting Calculation : P 377 / Schnittberechnung : P 377

Montaj Ölçüleri : S 374 / Mounting Reference : P 374 / Montagehinweis : P 374

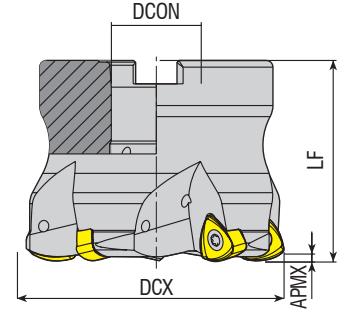

Takım Kodu Ordering Code Bestell-Bezeichnung	Stok Stock Lager	Takım Ölçüleri (mm) Dimension (mm) Abmessung (mm)					Kesici Uç Insert Wendeschneidplatte	Yedek Parçaları / Spare Parts / Ersatzteile		
		DCX	ZEFP	DCON	LF	APMX		Sıkma Vidası Screw Schraube	Tork Anahtar Torx Key Torx-Schlüssel	Montaj Vidası Mounting Screw Befestigungsschraube
AHFM-BL1205-D050-A22-Z03-H	●	50	3	22	40	2	BLMP 1205..	4015-M4x11	80-T15	2508-M10x30 2510-M12x35
AHFM-BL1205-D063-A22-Z04-H	●	63	4	22	40	2				
AHFM-BL1205-D080-A27-Z05-H	●	80	5	27	50	2				

TGTC Ucuna Uygunur. / Compatible with TGTC Insert. / Kompatibel mit TGTC Wendeplatten.

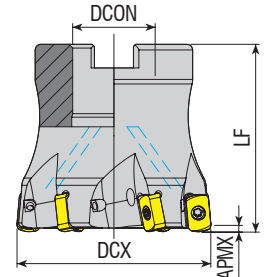

Takım Kodu Ordering Code Bestell-Bezeichnung	Stok Stock Lager	Takım Ölçüleri (mm) Dimension (mm) Abmessung (mm)					Kesici Uç Insert Wendeschneidplatte	Yedek Parçaları / Spare Parts / Ersatzteile		
		DCX	ZEFP	DCON	LF	APMX		Sıkma Vidası Screw Schraube	Tork Anahtar Torx Key Torx-Schlüssel	Montaj Vidası Mounting Screw Befestigungsschraube
AHFM-EN1004-D050-A22-Z05-H	●	50	5	22	50	1	ENMU 1004..	3008-M2.5X6	82-T08	2508-M10x30
AHFM-EN1004-D050-A22-Z06-H	●	50	6	22	50	1				
AHFM-EN1004-D052-A22-Z06-H	●	52	6	22	50	1				
AHFM-EN1004-D063-A22-Z06-H	●	63	6	22	50	1				

R: Sağ / Right / Rechts L: Sol / Left / Links

● Stokta / In Stock / Auf Lager ○ Stokta Yok / Non Stock Item / Kein Lagerartikel, Lieferzeit auf Anfrage  
DJT Ucuna Uygunur. / Compatible with DJT Insert. / Kompatibel mit DJT Wendeplatten.

Sipariş Örneği/Ordering Example/Bestellbeispiel

1 ad./pcs./stück AHFM-BL1205-D050-A22-Z03-H

Kesme Hesabı : S 377 / Cutting Calculation : P 377 / Schnittberechnung : P 377

Montaj Ölçüleri : S 374 / Mounting Reference : P 374 / Montagehinweis : P 374



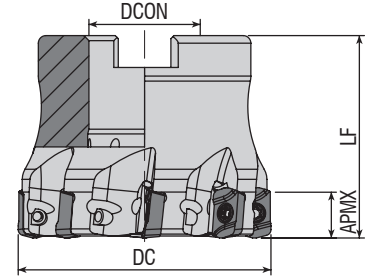

Takım Kodu Ordering Code Bestell-Bezeichnung	Stok Stock Lager	Takım Ölçüleri (mm) Dimension (mm) Abmessung (mm)					Kesici Uç Insert Wendeschneidplatte	Yedek Parçaları / Spare Parts / Ersatzteile		
		DC	ZEFP	DCON	LF	APMX		Sıkma Vidası Screw Schraube	Tork Anahtar Torx Key Torx-Schlüssel	Montaj Vidası Mounting Screw Befestigungsschraube
AHFM-EP1003-D050-A22-Z08-H	●	50	8	22	40	1				
AHFM-EP1003-D063-A22-Z08-H	●	63	8	22	40	1				

DJT Ucuna Uygunur. / Compatible with DJT Insert. / Kompatibel mit DJT Wendepfatten.

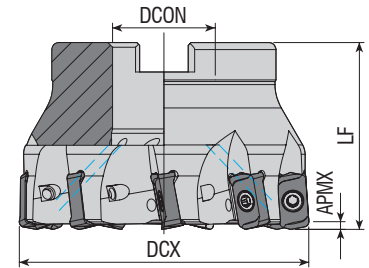

Takım Kodu Ordering Code Bestell-Bezeichnung	Stok Stock Lager	Takım Ölçüleri (mm) Dimension (mm) Abmessung (mm)					Kesici Uç Insert Wendeschneidplatte	Yedek Parçaları / Spare Parts / Ersatzteile		
		DCX	ZEFP	DCON	LF	APMX		Sıkma Vidası Screw Schraube	Tork Anahtar Torx Key Torx-Schlüssel	Montaj Vidası Mounting Screw Befestigungsschraube
AHFM-L003-D040-A16-Z06-H	●	40	6	16	40	1				2506-M8x30
AHFM-L003-D050-A22-Z07-H	●	50	7	22	40	1				2508-M10x30
AHFM-L003-D063-A22-Z09-H	●	63	9	22	40	1				

KYCR Ucuna Uygunur. / Compatible with KYCR Insert. / Kompatibel mit KYCR Wendepfatten.

Sipariş Örneği/Ordering Example/Bestellbeispiel

1 ad./pcs./stück AHFM-EP1003-D050-A22-Z08-H

Kesme Hesabı : S 377 / Cutting Calculation : P 377 / Schnittberechnung : P 377

Montaj Ölçüleri : S 374 / Mounting Reference : P 374 / Montagehinweis : P374

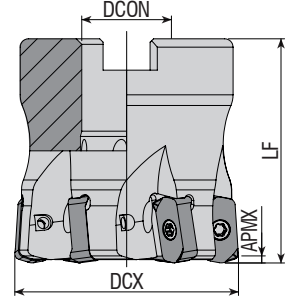

Takım Kodu Ordering Code Bestell-Bezeichnung	Stok Stock Lager	Takım Ölçüleri (mm) Dimension (mm) Abmessung (mm)					Kesici Uç Insert Wendeschneidplatte	Yedek Parçaları / Spare Parts / Ersatzteile				
		DCX	ZEFP	DCON	LF	APMX		Sıkma Vidası Screw Schraube	Tork Anahtar Torx Key Torx-Schlüssel	Montaj Vidası Mounting Screw Befestigungsschraube		
AHFM-LN0303-D040-A16-Z06-H	●	40	6	16	40	12	LNMU 0303..			2506-M8x30		
AHFM-LN0303-D050-A22-Z07-H	●	50	7	22	50	12				3008-M2.5X6	82-T08	2508-M10x30
AHFM-LN0303-D063-A22-Z09-H	●	63	9	22	50	12						

TNGYL Ucuna Uygundur. / Compatible with TNGYL Insert. / Kompatibel mit TNGYL Wendepalten.

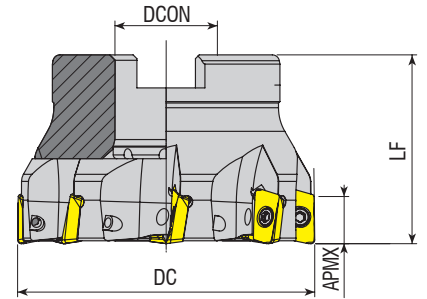

Takım Kodu Ordering Code Bestell-Bezeichnung	Stok Stock Lager	Takım Ölçüleri (mm) Dimension (mm) Abmessung (mm)					Kesici Uç Insert Wendeschneidplatte	Yedek Parçaları / Spare Parts / Ersatzteile		
		DC	ZEFP	DCON	LF	APMX		Sıkma Vidası Screw Schraube	Tork Anahtar Torx Key Torx-Schlüssel	Montaj Vidası Mounting Screw Befestigungsschraube
AHFM-JD1003-D040-A16-Z06-H	●	40	6	16	40	9	JDMT 1003..			2506-M8x30
AHFM-JD1003-D063-A22-Z08-H	●	63	8	22	40	9				3008-M2.5x6

HTCH Ucuna Uygundur. / Compatible with HTCH Insert. / Kompatibel mit HTCH Wendepalten.

Sipariş Örneği/Ordering Example/Bestellbeispiel





1 ad./pcs./stück AHFM-LN0303-D040-A16-Z06-H

Kesme Hesabı : S 377 / Cutting Calculation : P 377 / Schnittberechnung : P 377

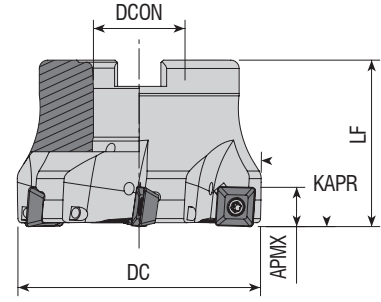
Montaj Ölçüleri : S 374 / Mounting Reference : P 374 / Montagehinweis : P374

new





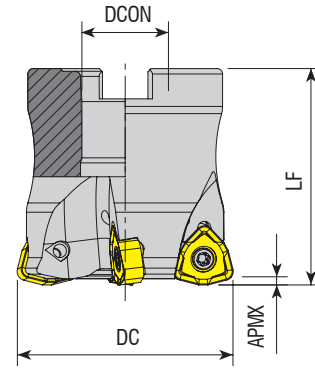

Takım Kodu Ordering Code Bestell-Bezeichnung	Stok Stock Lager	Takım Ölçüleri (mm) Dimension (mm) Abmessung (mm)					Kesici Uç Insert Wendeschneidplatte	Yedek Parçaları / Spare Parts / Ersatzteile		
		DC	ZEFP	DCON	LF	APMX		Sıkma Vidası Screw Schraube	Tork Anahtar Torx Key Torx-Schlüssel	Montaj Vidası Mounting Screw Befestigungsschraube
AHFM-SP0945-D050-A22-Z06-H	●	50	6	22	40	1.4				
AHFM-SP0945-D052-A22-Z06-H	●	52	6	22	40	1.4				

MTSBH Ucuna Uygunur. / Compatible with MTSBH Insert. / Kompatibel mit MTSBH Wendeplatten.

new



Takım Kodu Ordering Code Bestell-Bezeichnung	Stok Stock Lager	Takım Ölçüleri (mm) Dimension (mm) Abmessung (mm)					Kesici Uç Insert Wendeschneidplatte	Yedek Parçaları / Spare Parts / Ersatzteile		
		DC	ZEFP	DCON	LF	APMX		Sıkma Vidası Screw Schraube	Tork Anahtar Torx Key Torx-Schlüssel	Montaj Vidası Mounting Screw Befestigungsschraube
AHFM-J009-D050-A22-Z04-H	●	50	4	22	50	1.2				
AHFM-J009-D063-A22-Z05-H	●	63	5	22	50	1.2				

MTSBH Ucuna Uygunur. / Compatible with MTSBH Insert. / Kompatibel mit MTSBH Wendeplatten.

Sipariş Örneği/Ordering Example/Bestellbeispiel  
1 ad./pcs./stück AHFM-SP0945-D050-A22-Z06-H  
Kesme Hesabı : S 377 / Cutting Calculation : P 377 / Schnittberechnung : P 377

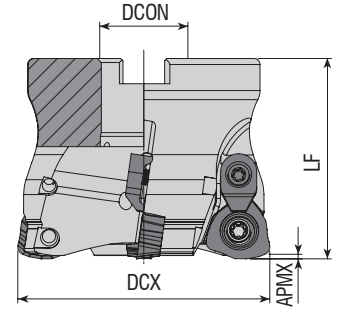

Takım Kodu Ordering Code Bestell-Bezeichnung	Stok Stock Lager	Takım Ölçüleri (mm) Dimension (mm) Abmessung (mm)					Kesici Uç Insert Wendeschneidplatte	Yedek Parçaları / Spare Parts / Ersatzteile				
		DCX	ZEFP	DCON	LF	APMX		Sıkma Vidası Screw Schraube	Baskı Pabucu Wedge Clamp Spannpratze	Baskı Vidası Clamp Screw Klemmschraube	Tork Anahtar Torx Key Torx-Schlüssel	Montaj Vidası Mounting Screw Befestigungsschraube
AHFMC-JD1204-D052-A22-Z03-H	●	52	3	22	50	1.5	JDMW 1204..	4615-M4x11	ACK-05	4015-M4x11	80-T15	2508-M10x30
AHFMC-JD1204-D052-A22-Z04-H	●	52	4	22	50	1.5						
AHFMC-JD1204-D063-A22-Z05-H	●	63	5	22	50	1.5						
AHFMC-JD1204-D080-A27-Z06-H	●	80	6	27	50	1.5						
AHFMC-JD1204-D100-A32-Z07-H	●	100	7	32	50	1.5						
AHFMC-JD1405-D052-A22-Z03-H	●	52	3	22	40	2	JDMW 1405..	1020-M5x11	80-T20	2408-M10x30		
AHFMC-JD1405-D063-A22-Z04-H	●	63	4	22	40	2					2508-M10x30	

MTSBH Ucuna Uygun. / Compatible with MTSBH Insert. / Kompatibel mit MTSBH Wendepfatten.

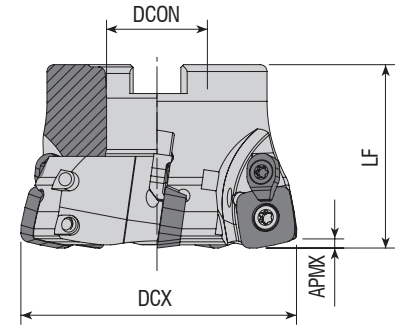
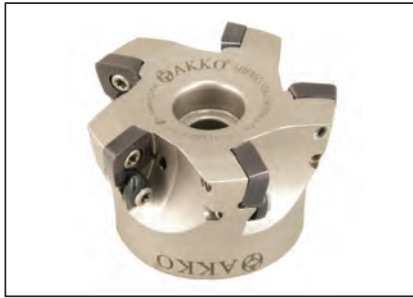

Takım Kodu Ordering Code Bestell-Bezeichnung	Stok Stock Lager	Takım Ölçüleri (mm) Dimension (mm) Abmessung (mm)					Kesici Uç Insert Wendeschneidplatte	Yedek Parçaları / Spare Parts / Ersatzteile				
		DCX	ZEFP	DCON	LF	APMX		Sıkma Vidası Screw Schraube	Baskı Pabucu Wedge Clamp Spannpratze	Baskı Vidası Clamp Screw Klemmschraube	Tork Anahtar Torx Key Torx-Schlüssel	Montaj Vidası Mounting Screw Befestigungsschraube
AHFMC-SD1204-D050-A22-Z04-H	●	50	4	22	40	1.8	SD.. 1204..	4015-M4x11	ACK-15	4015-M3.5x11	80-T15	2508-M10x30
AHFMC-SD1204-D063-A22-Z05-H	●	63	5	22	40	1.8						
AHFMC-SD1204-D080-A27-Z06-H	●	80	6	27	50	1.8						
AHFMC-SD1204-D100-A32-Z08-H	●	100	8	32	50	1.8						

ZCC Ucuna Uygun. / Compatible with ZCC Insert. / Kompatibel mit ZCC Wendepfatten.





Sipariş Örneği/Ordering Example/Bestellbeispiel

1 ad./pcs./stück AHFMC-JD1204-D052-A22-Z03-H

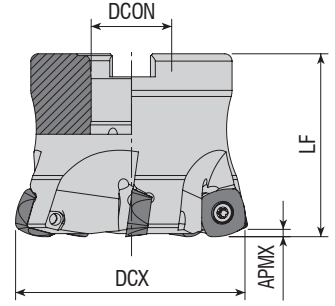
Kesme Hesabı : S 377 / Cutting Calculation : P 377 / Schnittberechnung : P 377





Montaj Ölçüleri : S 374 / Mounting Reference : P 374 / Montagehinweis : P374

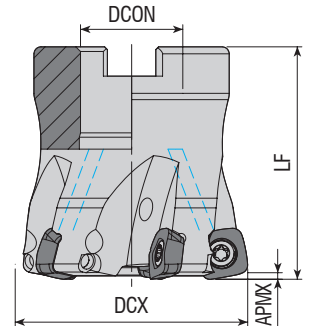

Takım Kodu Ordering Code Bestell-Bezeichnung	Stok Stock Lager	Takım Ölçüleri (mm) Dimension (mm) Abmessung (mm)					Kesici Uç Insert Wendeschneidplatte	Yedek Parçaları / Spare Parts / Ersatzteile		
		DCX	ZEFP	DCON	LF	APMX		Sıkma Vidası Screw Schraube	Tork Anahtar Torx Key Torx-Schlüssel	Montaj Vidası Mounting Screw Befestigungsschraube
AHFM-SD1205-D052-A22-Z04-H	●	52	4	22	50	2				
AHFM-SD1205-D052-A22-Z05-H	●	52	5	22	50	2				
<b>new</b> AHFM-SD1205-D063-A22-Z05-H	●	63	5	22	50	2				
AHFM-SD1205-D066-A22-Z05-H	●	66	5	22	50	2				
AHFM-SD1205-D066-A22-Z06-H	●	66	6	22	50	2				
AHFM-SD1205-D080-A27-Z06-H	●	80	6	27	70	2				

HTCH Ucuna Uygundur. / Compatible with HTCH Insert. / Kompatibel mit HTCH Wendeplatten.

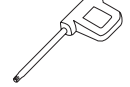

Takım Kodu Ordering Code Bestell-Bezeichnung	Stok Stock Lager	Takım Ölçüleri (mm) Dimension (mm) Abmessung (mm)					Kesici Uç Insert Wendeschneidplatte	Yedek Parçaları / Spare Parts / Ersatzteile		
		DCX	ZEFP	DCON	LF	APMX		Sıkma Vidası Screw Schraube	Tork Anahtar Torx Key Torx-Schlüssel	Montaj Vidası Mounting Screw Befestigungsschraube
AHFM-S01004-D050-A22-Z05-H	●	50	5	22	50	1.5				
AHFM-S01004-D063-A22-Z06-H	●	63	6	22	50	1.5				
AHFM-S01004-D080-A27-Z07-H	●	80	7	27	63	1.5				

KYCR Ucuna Uygundur. / Compatible with KYCR Insert. / Kompatibel mit KYCR Wendeplatten.





Sipariş Örneği/Ordering Example/Bestellbeispiel

1 ad./pcs./stück AHFM-SD1205-D052-A22-Z04-H

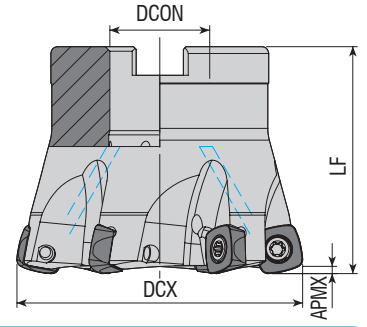
Kesme Hesabı : S 377 / Cutting Calculation : P 377 / Schnittberechnung : P 377









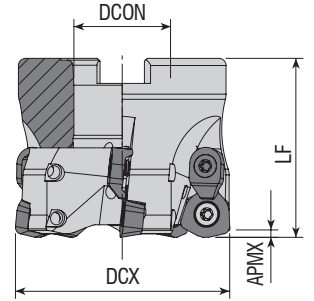









Montaj Ölçüleri : S 374 / Mounting Reference : P 374 / Montagehinweis : P374



Takım Kodu Ordering Code Bestell-Bezeichnung	Stok Stock Lager	Takım Ölçüleri (mm) Dimension (mm) Abmessung (mm)					Kesici Uç Insert Wendeschneidplatte	Yedek Parçaları / Spare Parts / Ersatzteile			
		DCX	ZEPF	DCON	LF	APMX		Sıkma Vidası Screw Schraube	Tork Anahtar Torx Key Torx-Schlüssel	Montaj Vidası Mounting Screw Befestigungsschraube	
AHFM-SP1004-D050-A22-Z05-H	●	50	5	22	50	1.5					
AHFM-SP1004-D052-A22-Z05-H	●	52	5	22	50	1.5					
AHFM-SP1004-D063-A22-Z06-H	●	63	6	22	50	1.5					

DJT Ucuna Uygunur. / Compatible with DJT Insert. / Kompatibel mit DJT Wendeplatten.



Takım Kodu Ordering Code Bestell-Bezeichnung	Stok Stock Lager	Takım Ölçüleri (mm) Dimension (mm) Abmessung (mm)					Kesici Uç Insert Wendeschneidplatte	Yedek Parçaları / Spare Parts / Ersatzteile										
		DCX	ZEPF	DCON	LF	APMX		Sıkma Vidası Screw Schraube	Baskı Pabucu Wedge Clamp Spannpratze	Baskı Vidası Clamp Screw Klemmschraube	Tork Anahtar Torx Key Torx-Schlüssel	Montaj Vidası Mounting Screw Befestigungsschraube						
AHFMC-WD06T3D-D042-A16-Z04-H	●	42	4	16	45	1.5												
AHFMC-WD06T3D-D050-A22-Z05-H	●	50	5	22	50	1.5												
AHFMC-WD06T3D-D052-A22-Z05-H	●	52	5	22	50	1.5												
AHFMC-WD06T3D-D063-A22-Z06-H	●	63	6	22	50	1.5												
AHFMC-WD0805D-D052-A22-Z04-H	●	52	4	22	50	2												
AHFMC-WD0805D-D063-A22-Z05-H	●	63	5	22	50	2												
AHFMC-WD0805D-D063-A27-Z05-H	●	63	5	27	50	2												
AHFMC-WD0805D-D066-A27-Z05-H	●	66	5	27	50	2												
AHFMC-WD0805D-D080-A27-Z05	●	80	5	27	50	2												
AHFMC-WD0805D-D100-A32-Z06	●	100	6	32	50	2												
AHFMC-WD10X6D-D125-B40-Z06	●	125	6	40	63	2.5												
AHFMC-WD10X6D-D160-C40-Z07	●	160	7	40	63	2.5												

DJT Ucuna Uygunur. / Compatible with DJT Insert. / Kompatibel mit DJT Wendeplatten.

Sipariş Örneği/Ordering Example/Bestellbeispiel

1 ad./pcs./stück AHFM-SP1004-D050-A22-Z05-H

Kesme Hesabı : S 377 / Cutting Calculation : P 377 / Schnittberechnung : P 377

Montaj Ölçüleri : S 374 / Mounting Reference : P 374 / Montagehinweis : P374

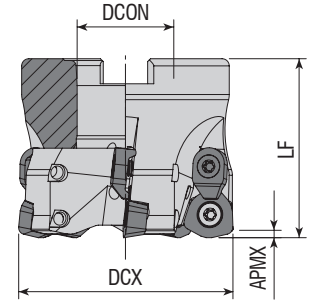

Takım Kodu Ordering Code Bestell-Bezeichnung	Stok Stock Lager	Takım Ölçüleri (mm) Dimension (mm) Abmessung (mm)					Kesici Uç Insert Wendeschneidplatte	Yedek Parçaları / Spare Parts / Ersatzteile					
		DCX	ZEFP	DCON	LF	APMX		Sıkma Vidası Screw Schraube	Baskı Pabucu Wedge Clamp Spannpratze	Baskı Vidası Clamp Screw Klemmschraube	Tork Anahtar Torx Key Torx-Schlüssel	Montaj Vidası Mounting Screw Befestigungsschraube	
AHFMC-WD0804-D040-A16-Z04-H	●	40	4	16	40	1.5	WDMT 0804..	4010-M3x8	ACK-15	4010-M3x8	82-T10	2506-M8x30	
AHFMC-WD0804-D050-A22-Z04-H	●	50	4	22	50	1.5							
AHFMC-WD1205-D050-A22-Z04-H	●	50	4	22	50	3	WDMT 1205..	1415-M4x11	ACK-05	4015-M4x11	80-T15		2508-M10x30
AHFMC-WD1205-D052-A22-Z04-H	●	52	4	22	50	3							
AHFMC-WD1205-D063-A22-Z05-H	●	63	5	22	50	3							
AHFMC-WD1205-D080-A27-Z06-H	●	80	6	27	63	3							2510-M12x35

SMTM Ucuna Uygun. / Compatible with SMTM Insert. / Kompatibel mit SMTM Wendeplatten.

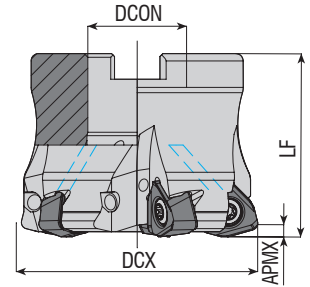

Takım Kodu Ordering Code Bestell-Bezeichnung	Stok Stock Lager	Takım Ölçüleri (mm) Dimension (mm) Abmessung (mm)					Kesici Uç Insert Wendeschneidplatte	Yedek Parçaları / Spare Parts / Ersatzteile					
		DCX	ZEFP	DCON	LF	APMX		Sıkma Vidası Screw Schraube	Tork Anahtar Torx Key Torx-Schlüssel	Montaj Vidası Mounting Screw Befestigungsschraube			
AHFMC-WD0804-D040-A16-Z04-H	●	40	4	16	40	1.5	WDMT 0804..	4010-M3x8	ACK-15	4010-M3x8	82-T10	2506-M8x30	
AHFMC-WD0804-D050-A22-Z04-H	●	50	4	22	50	1.5							
AHFMC-WD1205-D050-A22-Z04-H	●	50	4	22	50	3	WDMT 1205..	1415-M4x11	ACK-05	4015-M4x11	80-T15		2508-M10x30
AHFMC-WD1205-D052-A22-Z04-H	●	52	4	22	50	3							
AHFMC-WD1205-D063-A22-Z05-H	●	63	5	22	50	3							
AHFMC-WD1205-D080-A27-Z06-H	●	80	6	27	63	3							2510-M12x35
AHFMC-WD1205-D100-A32-Z07-H	●	100	7	32	100	3					2514-M16x35		

DJT Ucuna Uygun. / Compatible with DJT Insert. / Kompatibel mit DJT Wendeplatten.

Sipariş Örneği/Ordering Example/ Bestellbeispiel  
1 ad./pcs./stück AHFMC-WD0804-D040-A16-Z04-H  
Kesme Hesabı : S 377 / Cutting Calculation : P 377 / Schnittberechnung : P 377  
Montaj Ölçüleri : S 374 / Mounting Reference : P 374 / Montagehinweis : P 374

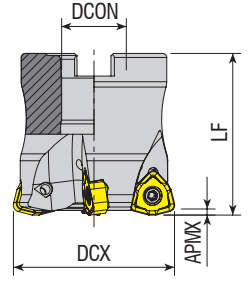

Takım Kodu Ordering Code Bestell-Bezeichnung	Stok Stock Lager	Takım Ölçüleri (mm) Dimension (mm) Abmessung (mm)					Kesici Uç Insert Wendeschneidplatte	Yedek Parçaları / Spare Parts / Ersatzteile		
		DCX	ZEFP	DCON	LF	APMX		Sıkma Vidası Screw Schraube	Tork Anahtar Torx Key Torx-Schlüssel	Montaj Vidası Mounting Screw Befestigungsschraube
AHFM-WN09T3-D040-A16-Z04-H	●	40	4	16	40	1.5	WVMX 09T3..	4010-M3x8	82-T10	2506-M8x30
AHFML-WN09T3-D040-A16-Z04-H	●	40	4	16	40	1.5				
AHFM-WN09T3-D050-A22-Z05-H	●	50	5	22	40	1.5				2508-M10x30
AHFML-WN09T3-D050-A22-Z05-H	●	50	5	22	40	1.5				
AHFM-WN09T3-D063-A22-Z06-H	●	63	6	22	40	1.5				

R: Sağ / Right / Rechts L: Sol / Left / Links

● Stokta / In Stock / Auf Lager ○ Stokta Yok / Non Stock Item / Kein Lagerartikel, Lieferzeit auf Anfrage  
KRLY Ucuna Uygun. / Compatible with KRLY Insert. / Kompatibel mit KRLY Wendeplatten.

Sipariş Örneği/Ordering Example/Bestellbeispiel

1 ad./pcs./stück AHFM-WN09T3-D040-A16-Z04-H

Kesme Hesabı : S 377 / Cutting Calculation : P 377 / Schnittberechnung : P 377

Montaj Ölçüleri : S 374 / Mounting Reference : P 374 / Montagehinweis : P374





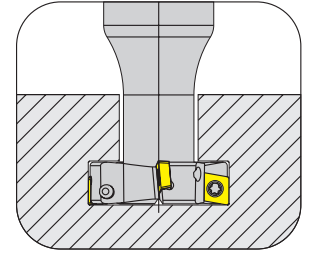
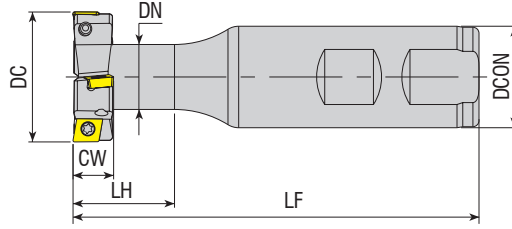

Takım Kodu  
Ordering Code  
Bestell-Bezeichnung

Stok  
Stock  
Lager

ZEFP  
Toplam  
Total  
Gesamt

Etkili  
Effective  
Effektiv

DC

CW

DCON

LF

DN

LH

Takım Ölçüleri (mm)  
Dimension (mm)  
Abmessung (mm)

Kesici Uç  
Insert  
Wendeschneidplatte

Yedek Parçaları / Spare Parts / Ersatzteile

Sıkma Vidası  
Screw  
Schraube

Tork Anahtar  
Torx Key  
Torx-Schlüssel



	Stok	ZEFP	DC	CW	DCON	LF	DN	LH	Kesici Uç	Sıkma Vidası	Tork Anahtar
	Stock	Toplam							Insert	Screw	Torx Key
	Lager	Total							Wendeschneidplatte	Schraube	Torx-Schlüssel
		Gesamt	Effektiv								
ATSM90-CC06-D17X8-W16-L85-Z02	●	2	1	17	8	16	85	10	CC.T 0602..	3008-M2.5x6	82-T08
ATSM90-CC06-D22X8-W20-L83-Z04	●	4	2	22	8	20	83	9			
ATSM90-CC06-D32X8-W25-L100-Z04	●	4	2	32	8	25	100	16			
ATSM90-CC06-D28X8-W20-L66-Z04	●	4	2	28	8	20	66	14			
ATSM90-CC06-D45.5X8-W25-L100-Z06	●	6	3	45.5	8	25	100	12			
ATSM90-CC06-D63X8-W32-L125-Z08	●	8	4	63	8	32	125	31.5			
ATSM90-CC06-D18X9-W16-L90-Z02	●	2	1	18	9	16	90	10			
ATSM90-CC06-D20X9-W16-L85-Z04	●	4	2	20	9	16	85	10			
ATSM90-CC06-D23X10-W20-L90-Z04	●	4	2	23	10	20	90	12			
ATSM90-CC06-D32X10-W25-L100-Z04	●	4	2	32	10	25	100	16			
ATSM90-CC06-D45X10-W32-L120-Z06	●	6	3	45	10	32	120	20			
ATSM90-CC06-D25X11-W25-L100-Z04	●	4	2	25	11	25	100	13			
ATSM90-CC09-D30X12-W25-L100-Z04	●	4	2	30	12	25	100	16			
ATSM90-CC09-D32X12-W25-L100-Z02	●	2	1	32	12	25	100	16			
ATSM90-CC09-D32X12-W25-L100-Z04	●	4	2	32	12	25	100	16			
ATSM90-CC09-D32X14-W25-L100-Z04	●	4	2	32	14	25	100	16			
ATSM90-CC09-D37X16-W32-L120-Z04	●	4	2	37	16	32	120	17			
ATSM90-CC09-D40X17-W32-L120-Z04-H	●	4	2	40	17	32	120	19			
ATSM90-CC09-D42X17-W32-L120-Z04	●	4	2	42	17	32	120	19			
ATSM90-CC12-D47X20-W32-L120-Z04	●	4	2	47	20	32	120	25			
ATSM90-CC12-D52X21-W32-L120-Z04	●	4	2	52	21	32	120	25			
ATSM90-CC12-D50X22-W32-L120-Z04	●	4	2	50	22	32	120	25			
ATSM90-CC12-D55X22-W32-L120-Z04	●	4	2	55	22	32	120	25			

R: Sağ / Right / Rechts L: Sol / Left / Links

● Stokta / In Stock / Auf Lager ○ Stokta Yok / Non Stock Item / Kein Lagerartikel, Lieferzeit auf Anfrage

Sipariş Örneği/Ordering Example/Bestellbeispiel

1 ad./pcs./stück ATSM90-CC06-D17X8-W16-L85-Z02

Kesme Hesabı : S 367 / Cutting Calculation : P 367 / Schnittberechnung : P 367



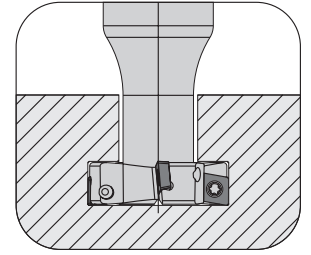
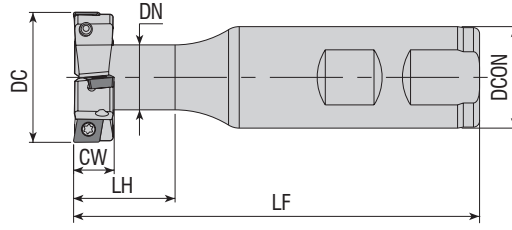

Takım Kodu Ordering Code Bestell-Bezeichnung	Stok Stock Lager	Takım Ölçüleri (mm) Dimension (mm) Abmessung (mm)							Kesici Uç Insert Wendeschneidplatte	Yedek Parçaları / Spare Parts / Ersatzteile		
		ZEFP		DC	CW	DCON	LF	DN		LH	Sıkma Vidası Screw Schraube	Tork Anahtar Torx Key Torx-Schlüssel
		Toplam Total Gesamt	Etkili Effektiv Effektiv									
ATSM90-SP.05-D22.5X5-W25-L100-Z04	●	4	2	22.5	5	25	100	12	25	SPMG 050204 TGTC UCUNA UYGUNDUR. FOR TGTC INSERT. Kompatibel mit TGTC Wendepaletten	3006-M2x4	82-T06
ATSM90-SP.05-D25X5-W25-L100-Z04	○	4	2	25	5	25	100	9	25			
ATSM90-SP.05-D30X5-W25-L100-Z04	●	4	2	30	5	25	100	10	25			
ATSM90-SPGT0502-D63X6-W32-L125-Z10	●	10	5	63	6	32	125	31	30	SPGT 050204	4015-M3.5x9	80-T15
ATSM90-SPGT0904-D32X14-W32-L120-Z04-H	●	4	2	32	14	32	120	17.5	30	SPGT 090408 ZCC UCUNA UYGUNDUR. FOR ZCC INSERT. Kompatibel mit ZCC Wendepaletten		
ATSM90-SPGT0904-D37X16-W32-L120-Z04-H	●	4	2	37	16	32	120	21	40			
ATSM90-SPGT0904-D42X17-W32-L120-Z04-H	●	4	2	42	17	32	120	21	40	SPGT 110408	4015-M4x11	82-T07
ATSM90-SPGT1104-D47X20-W32-L120-Z04-H	●	4	2	47	20	32	120	24	45	SPMG 060204 TGTC UCUNA UYGUNDUR. FOR TGTC INSERT. Kompatibel mit TGTC Wendepaletten		
ATSM90-SP.06-D80X7-W32-L120-Z10	●	10	5	80	7	32	120	32	30	3007-M2.2x4.6		

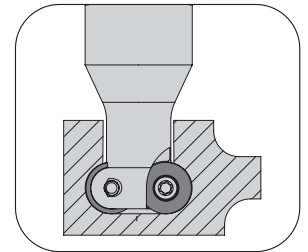
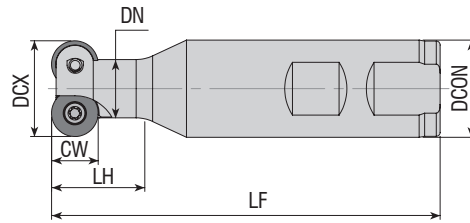

Takım Kodu Ordering Code Bestell-Bezeichnung	Stok Stock Lager	Takım Ölçüleri (mm) Dimension (mm) Abmessung (mm)							Kesici Uç Insert Wendeschneidplatte	Yedek Parçaları / Spare Parts / Ersatzteile		
		ZEFP		DCX	CW	DCON	LF	DN		LH	Sıkma Vidası Screw Schraube	Tork Anahtar Torx Key Torx-Schlüssel
		Toplam Total Gesamt	Etkili Effektiv Effektiv									
ATSMR-RD0702-D17-W16-L90-Z02	●	2	2	17	7	16	90	10	12	RD.. 0702	3008-M2.5x6	82-T08
ATSMR-RD0702-D25-W16-L90-Z03	●	3	2	25	7	16	90	15	12			
ATSMR-RD0702-D35-W25-L100-Z05	●	5	2	35	7	25	100	20	20			
ATSMR-RD1003-D21-W25-L100-Z02	●	2	2	21	10	25	100	12	20	RD.. 1003	4015-M3.5x9	80-T15
ATSMR-RD1003-D80-W32-L165-Z06-H	●	6	2	80	10	32	165	30	31.5			
ATSMR-RD12T3-D25-W25-L100-Z02	●	2	2	25	12	25	100	15	24			
ATSMR-RD12T3-D80-W32-L165-Z06-H	●	6	2	80	12	32	165	30	31.5	RD.. 12T3	4015-M4.5x11	
ATSMR-RD1604-D34-W32-L110-Z02	●	2	2	34	16	32	110	20	30	RD.. 1604		

R: Sağ / Right / Rechts L: Sol / Left / Links

● Stokta / In Stock / Auf Lager ○ Stokta Yok / Non Stock Item / Kein Lagerartikel, Lieferzeit auf Anfrage  
ISO Ucuna Uygun. / Compatible with ISO Insert. / Kompatibel mit ISO Wendepaletten.

Sipariş Örneği/Ordering Example/Bestellbeispiel  
1 ad./pcs./stück ATSM90-SP.05-D22.5X5-W25-L100-Z04  
Kesme Hesabı : S 367 / Cutting Calculation : P 367 / Schnittberechnung : P 367

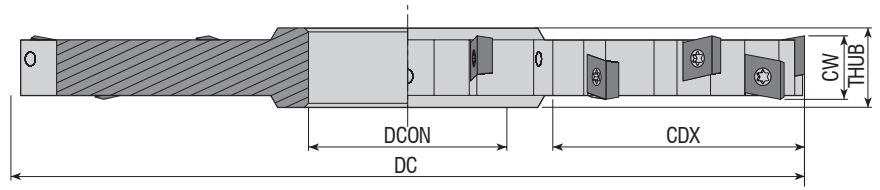

**Takım Kodu**  
**Ordering Code**  
**Bestell-Bezeichnung**

Stok  
Stock  
Lager

ZEPF

Toplam  
Total  
Gesamt

Etkili  
Effective  
Effektiv

DC

CW

CDX

DCON

THUB

Takım Ölçüleri (mm)  
Dimension (mm)  
Abmessung (mm)

Kesici Uç  
Insert  
Wendeschneidplatte

Yedek Parçaları / Spare Parts / Ersatzteile

Sıkma Vidası  
Screw  
Schraube

Tork Anahtar  
Torx Key  
Torx-Schlüssel

ASDM-SPGT05-D80x6-d27-Z10	●	10	5	80	6	17	27	10	<b>SPGT 050204</b> <b>ZCC UCUNA</b> <b>UYGUNDUR.</b> <i>FOR ZCC INSERT.</i> <i>Kompatibel mit ZCC Wendeschneidplatten</i>	 3006-M2x4	 82-T06
ASDM-SPGT05-D100x6-d32-Z12	●	12	6	100	6	25	32	10			
ASDM-SPGT05-D125x6-d40-Z14	●	14	7	125	6	35	40	10			
ASDM-SPGT05-D160x6-d40-Z18	●	18	9	160	6	52	40	10			
ASDM-SPGT06-D80x7-d27-Z10	●	10	5	80	7	17	27	11	<b>SPGT 060204</b> <b>ZCC UCUNA</b> <b>UYGUNDUR.</b> <i>FOR ZCC INSERT.</i> <i>Kompatibel mit ZCC Wendeschneidplatten</i>	 3007-M2.2x4.6	 82-T07
ASDM-SPGT06-D100x7-d32-Z12	●	12	6	100	7	25	32	11			
ASDM-SPGT06-D125x7-d40-Z14	●	14	7	125	7	35	40	11			
ASDM-SPGT06-D160x7-d40-Z16	●	16	8	160	7	52	40	11			
ASDM-SPGT06-D200x7-d40-Z18	●	18	9	200	7	70	40	11	<b>SPGT 07T308</b>	 3008-M2.5x6	 82-T08
<b>new</b> ASDM-SPGT07-D100x10-d27-Z10	●	10	5	100	10	26.5	27	14			
ASDM-SPGT07-D100x10-d32-Z12	●	12	6	100	10	25	32	11			

R: Sağ / Right / Rechts L: Sol / Left / Links

● Stokta / In Stock / Auf Lager ○ Stokta Yok / Non Stock Item / Kein Lagerartikel, Lieferzeit auf Anfrage

Sipariş Örneği/Ordering Example/Bestellbeispiel

1 ad./pcs./stück ASDM-SPGT05-D80x6-d27-Z10

Kesme Hesabı : S 367 / Cutting Calculation : P 367 / Schnittberechnung : P 367



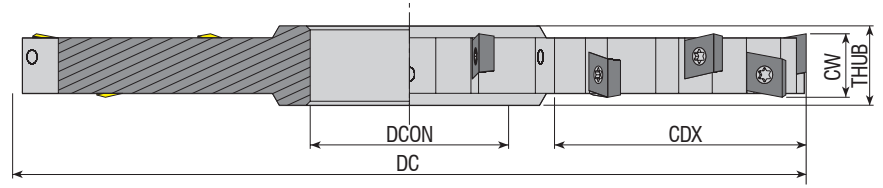

Takım Kodu  
Ordering Code  
Bestell-Bezeichnung

Stok  
Stock  
Lager

ZEFP

Toplam  
Total  
Gesamt

Etkili  
Effective  
Effektiv

DC

CW

CDX

DCON

THUB

Takım Ölçüleri (mm)  
Dimension (mm)  
Abmessung (mm)

Kesici Uç  
Insert  
Wendeschneidplatte

Yedek Parçaları / Spare Parts / Ersatzteile

Sıkma Vidası  
Screw  
Schraube

Tork Anahtar  
Torx Key  
Torx-Schlüssel



Takım Kodu Ordering Code Bestell-Bezeichnung	Stok Stock Lager	Takım Ölçüleri (mm) Dimension (mm) Abmessung (mm)						Kesici Uç Insert Wendeschneidplatte	Sıkma Vidası Screw Schraube	Tork Anahtar Torx Key Torx-Schlüssel	
		ZEFP		DC	CW	CDX	DCON				THUB
		Toplam Total Gesamt	Etkili Effective Effektiv	DC	CW	CDX	DCON	THUB			
ASDM-CC06-D80x8-d27-Z10	●	10	5	80	8	17	27	12	CC.T 0602.. ISO UCUNA UYGUNDUR. FOR ISO INSERT. Kompatibel mit ISO Wendepplatten.	3008-M2.5x6	82-T08
ASDM-CC06-D100x8-d32-Z12	●	12	6	100	8	25	32	12			
ASDM-CC06-D125x8-d40-Z14	●	14	7	125	8	35	40	12			
ASDM-CC06-D160x8-d40-Z16	●	16	8	160	8	52	40	12			
ASDM-CC06-D200x8-d40-Z18	●	18	9	200	8	70	40	12			
ASDM-CC06-D80x10-d27-Z10	●	10	5	80	10	17	27	14			
ASDM-CC06-D100x10-d32-Z12	●	12	6	100	10	25	32	14			
ASDM-CC06-D125x10-d40-Z14	●	14	7	125	10	35	40	14			
ASDM-CC06-D160x10-d40-Z16	●	16	8	160	10	52	40	14			
ASDM-CC06-D200x10-d40-Z18	●	18	9	200	10	70	40	14			
ASDM-CC09-D80x12-d27-Z08	●	8	4	80	12	17	27	16	CC.T 09T3.. ISO UCUNA UYGUNDUR. FOR ISO INSERT. Kompatibel mit ISO Wendepplatten.	4015-M3.5x11	80-T15
ASDM-CC09-D100x12-d32-Z10	●	10	5	100	12	25	32	16			
ASDM-CC09-D125x12-d40-Z12	●	12	6	125	12	35	40	16			
ASDM-CC09-D160x12-d40-Z14	●	14	7	160	12	52	40	16			
ASDM-CC09-D200x12-d40-Z16	●	16	8	200	12	70	40	16			
ASDM-CC09-D80x14-d27-Z08	●	8	4	80	14	17	27	18			
ASDM-CC09-D100x14-d32-Z10	●	10	5	100	14	25	32	18			
ASDM-CC09-D125x14-d40-Z12	●	12	6	125	14	35	40	18			
ASDM-CC09-D160x14-d40-Z14	●	14	7	160	14	52	40	18			
ASDM-CC09-D200x14-d40-Z16	●	16	8	200	14	70	40	18			
ASDM-CC12-D80x16-d27-Z06	●	6	3	80	16	17	27	20	CC.T 1204.. ISO UCUNA UYGUNDUR. FOR ISO INSERT. Kompatibel mit ISO Wendepplatten.	1020-M5x11	80-T20
ASDM-CC12-D100x16-d32-Z08	●	8	4	100	16	25	32	20			
ASDM-CC12-D125x16-d40-Z10	●	10	5	125	16	35	40	20			
ASDM-CC12-D160x16-d40-Z12	●	12	6	160	16	52	40	20			
ASDM-CC12-D200x16-d40-Z14	●	14	7	200	16	70	40	20			
ASDM-CC12-D80x18-d27-Z06	●	6	3	80	18	17	27	22			
ASDM-CC12-D100x18-d32-Z08	●	8	4	100	18	25	32	22			
ASDM-CC12-D125x18-d40-Z10	●	10	5	125	18	35	40	22			
ASDM-CC12-D160x18-d40-Z12	●	12	6	160	18	52	40	22			
ASDM-CC12-D200x18-d40-Z14	●	14	7	200	18	70	40	22			
ASDM-CC12-D250x18-d40-Z16	●	16	8	250	18	90	40	22			
ASDM-CC12-D80x20-d27-Z06	●	6	3	80	20	17	27	24			
ASDM-CC12-D100x20-d32-Z08	●	8	4	100	20	25	32	24			
ASDM-CC12-D125x20-d40-Z10	●	10	5	125	20	35	40	24			
ASDM-CC12-D160x20-d40-Z12	●	12	6	160	20	52	40	24			
ASDM-CC12-D200x20-d40-Z14	●	14	7	200	20	70	40	24			
ASDM-CC12-D250x20-d40-Z16	●	16	8	250	20	90	40	24			

R: Sağ / Right / Rechts L: Sol / Left / Links

● Stokta / In Stock / Auf Lager ○ Stokta Yok / Non Stock Item / Kein Lagerartikel, Lieferzeit auf Anfrage

Sipariş Örneği/Ordering Example/Bestellbeispiel

1 ad./pcs./stück ASDM-CC06-D80x8-d27-Z10

Kesme Hesabı : S 367 / Cutting Calculation : P 367 / Schnittberechnung : P 367

**konusulan**  
**the spoken kalite...**  
**quality...**



A TIP / A TYPE / A-Typ

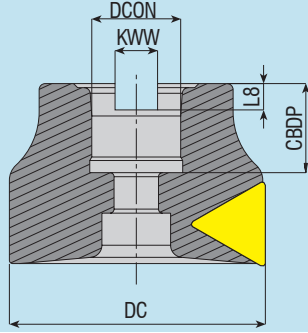

DC	DCON	DBC	KWW	L8	CBDP
40	16	-	8.4	5.6	20
50	22	-	10.4	6.3	22
63	22	-	10.4	6.3	22
80	27	-	12.4	7	25
100	32	-	14.4	8	26

B TIP / B TYPE / B-Typ

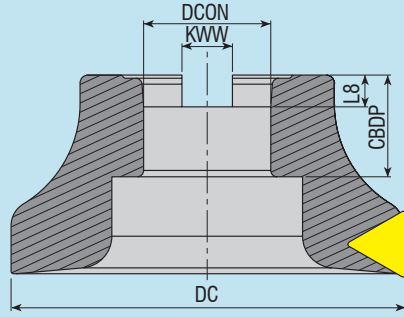

DC	DCON	DBC	KWW	L8	CBDP
125	40	-	16.4	9	32

C TIP / C TYPE / C-Typ

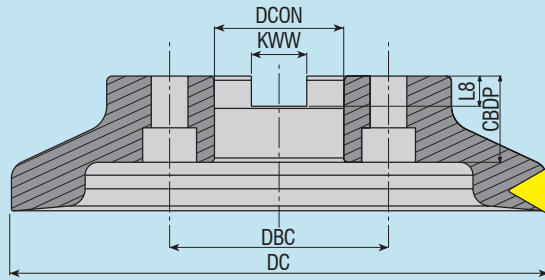

DC	DCON	DBC	KWW	L8	CBDP
160	40	66.7	16.4	9	32
200	60	101.6	25.7	14	40
250	60	101.6	25.7	14	40

D TIP / D TYPE / D-Typ

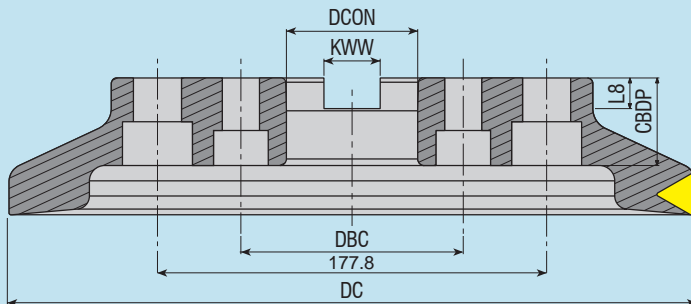

DC	DCON	DBC	KWW	L8	CBDP
315	60	101.6	25.7	14	40

## TAKMA UÇLU MATKAP (U-DRILL) KULLANMA KILAVUZU

Matkabınızı CNC torna tezgahına bağlamadan önce taretin merkezden kaçık olup olmadığını kontrol etmeniz gerekir. Şayet taretinizde kaçıklık varsa, takma uçlu matkabınızı kesinlikle kullanmayınız. Taretin düzeltilmesi için yapılması gereken işlemler ;

1. Taretin tutucusuna kullanacağınız takma uçlu matkabın çapında ve boyunda üzeri hassas olan silindirik bir parça bağlanır ve tazgahın X değeri sıfıra getirilir.
2. Tezgahın aynasına mıknatıslı komprotör saati yerleştirilir. Saatin uç kısmı tarete bağlanmış olduğumuz parçanın üstüne temas ettirilir.
3. Aynanın üzerine bağlanmış olduğumuz mıknatıslı komprotör ayna ile beraber 360 derece döndürülerek saatteki değişim oranına göre taretin sıfırlanması sağlanır.

## TAKMA UÇLU MATKABINIZI CNC TORNANIZDA DAHA VERİMLİ KULLANMANIZ İÇİN GEREKLİ OLAN KESME HIZLARI ve DEVİRLERİ :

Grup No.	Malzemenin Cinsi	Malzemenin Öz.	Kesme Hızı Vc (m/dk)
1	Çok Yumuşak İş Çelikleri	C1010, Otomat vb.	220
2	İmalat Çelik ve Döküm Malz.	C1030 - 106 vb.	200
3	Takım ve İmalat Çeşitleri	CK-45, 4140, 7131 vb.	170
4	Sıcak İş ve Paslanmaz Çelikler	İmpaks vb.	150

Devir hesabı yapabilmek için önce malzemeyi seçiniz. Seçtiğiniz malzemenin kesme hızını (Vc) 1000 ile çarpıp 3.14'e bölmeliyiz. Çıkan değeri matkap çapına bölmeliyiz. **ÖRNEK** : Malzememiz takım ve imalat çeliği (3. grup), matkap çapı 25 mm kesme hızı 170 ise  $170 \times 1000 = 170000 / 3.14 = 54140$ ,  $54140 / 25 = 2166$  devir çıkar (Tezgahın İş Mili Devri). Tezgahın ilerlemesi kullanacağınız uç ile de alakalı olup 0.05 ile 0.10 arasında değişim gösterir. Kullanıcı kesici ucun kesişine göre bunu ayarlar.

## İŞLEME MERKEZLERİ İÇİN İLERLEME HESABI :

Yukarıdaki hesaplamalarla bulmuş olduğunuz 2166 iş mili devrini, kesici uç ilerlemesi (mm/devir) 0.05 ile 0.10 arasındaki ilerleme seçenekleri ile çarpılır. **ÖRNEK 1** :  $2166 \times 0.05 = 108$  **ÖRNEK 2** :  $2116 \times 0.10 = 217$  çıkan sonuçlar 108 ve 217 işleme merkezleri için ilerleme mm/dakika hesabıdır.

Not: D4 ve üzeri takma uçlu matkaplarda tezgahın içten su verme basıncının en az 6 bar olması gerekmektedir.

## USER'S GUIDE FOR AKKO U-DRILLS

Before connecting your U-Drill to CNC lathe, you have to check if the turret is eccentric from the center or not. If there is any eccentricity in your turret, never use your U-Drill;

Processes that should be done to fix the turret :

1. A cylindrical part whose surface is precision and whose length and diameter is the same with the U-Drill that you will use, should be mounted to the holder of turret and X value of the lathe should be brought to zero ( 0 ).
2. Comparator should be mounted to chuck. The end of the comparator should be contacted ( touched ) to the surface of the part that we mounted on the turret.
3. The comparator that we mounted on the chuck should be turned 360-degree with the chuck and turret should be zeroed by that turning according to changing rate of comparator.

## CUTTING SPEED AND REVOLUTION THAT ARE NEEDED FOR USING ( RUNNING ) YOUR U-DRILLS MORE PRODUCTIVELY

Grup No.	Material	Material Type	Cutting Speed Vc ( m/m)
1	Non-alloy steel and free cutting steel	C1010. Automat etc.	220
2	Low alloy steel and cast steel	C1030 - 106 etc.	200
3	Alloy steel and tool steel	CK-45, 4140, 7131 etc.	170
4	Hot Work Steel and Stainless Steel	Impax etc.	150

P.S. : The cutting speed may be concerned with the type of the insert that you use.

Fistly, choose the material to make calculation of revolution. You should multiply the cutting speed (Vc) of the material that you chose by 1000 and divide by 3.14. You should divide the value that you found by the diameter of U-Drill. For Example : If our material is alloy steel and tool steel ( 3rd group ), diameter of the U-Drill is 25 mm, cutting speed is 170, we should calculate as following;  $170 \times 1000 = 170000 / 3.14 = 54140$ ,  $54140 / 25 = 2166$  rpm is the result that we found ( Spindle Speed ) Feed rate of the lathe is concerned with the U-Drill that you will use and changes between 0.05 and 0.10. The user sets it according to cut of cutting insert.

## FEED CALCULATION FOR CENTRAL MACHINE :

2166 spindle speed, that we found as a result of above mentioned calculation, should be multiplied by cutting insert feed ( mm/r ) between 0.05 and 0.10 feed choisses. Example 1 :  $2166 \times 0.05 = 108$

Example 2 :  $2116 \times 0.10 = 217$  The results 108 and 217 are the feed mm/m calculation for central machine.

Note: Cooling water pressure of lathe must be minimum 6 bar for our D4 u-drills and u-dirlls longer than D4.

## GEBRAUCHSANLEITUNG FÜR AKKO-VOLLBOHRER

Bevor Sie den Vollbohrer auf die Drehmaschine montieren, prüfen Sie bitte ob der Revolverkopf zentrisch sitzt. Sollte der Revolverkopf aus der Mitte stehen, benutzen Sie den Vollbohrer bitte nicht. Auf folgende Weise können Sie den Revolverkopf zentrieren:

1. Setzen Sie ein präzises Drehteil, das die gleiche Länge und den gleichen Durchmesser hat wie der eingesetzte Vollbohrer, in den Halter vom Revolverkopf und justieren Sie den X-Wert der Drehmaschine auf null.
2. Setzen Sie bitte einen Messtaster in das Spannfutter ein. Der Fühler des Messtasters sollte mit der Oberfläche des Präzisionsteils im Revolver Kontakt haben.
3. Drehen Sie nun das Spannfutter mit dem Messtaster um 360°. Die angezeigte Abweichung zwischen Futter und Revolver sollte null betragen.

### SNITTGESCHWINDIGKEIT UND DREHZAHL UM DIE VOLLBOHRER WIRTSCHAFTLICH EINZUSETZEN

Hauptgruppe	Hauptgruppe	Materialbezeichnung	Schnittgeschwindigkeit vc (m/min.)
1	Nicht Legierter Stahl und Automatenstahl	C1010. Automatenstahl	220
2	Niedrig Legierter Stahl und Stahlguss	C1030 - 106 vb.	200
3	Legierter Stahl und Werkzeugstahl	CK-45, 4140, 7131 vb.	170
4	Warmarbeitsstahl und Rostfreier Stahl	Impax und weitere Chrom-Nickel-Stähle	150

P.S.: Die genaue Schnittgeschwindigkeit hängt von der verwendeten Wendeschneidplatte ab. In Abhängigkeit vom Material wählen Sie die Schnittgeschwindigkeit vc. Diesen Wert multiplizieren Sie mit 1000 und teilen ihn durch 3,14 und den Durchmesser des Werkzeugs (in mm).

Beispiel: Rostfreier Stahl (Hauptgruppe 3), Werkzeugdurchmesser 25 mm, Schnittgeschwindigkeit vc=170 m/min. Die Berechnung sieht wie folgt aus:  $170 \times 1000 = 170000 / 3,14 = 54140 / 25 = 2166$  U/min. (Spindeldrehzahl). Der Vorschub der Maschine hängt vom Vollbohrer und der verwendeten Wendeschneidplatte ab und variiert zwischen 0,05 mm und 0,1 mm / Umdrehung.

### VORSCHRUBBERECHNUNG :

Die oben berechnete Spindeldrehzahl von 2166 wird mit dem Vorschub 0,05 mm und 0,1 mm multipliziert.  $2166 \text{ Umdr./min.} \times 0,05 \text{ mm/Umdr.} = 108 \text{ mm/min.}$   $2166 \text{ Umdr./min.} \times 0,1 \text{ mm/Umdr.} = 216 \text{ mm/min.}$  D.h. der Vorschub liegt zwischen 108 mm/min. und 216 mm/min. Hinweis: Der Kühlmitteldruck muss mindestens 6 bar betragen für die Vollbohrer mit  $\geq 4xD$

## SIKMA TORKU TAVSİYELERİ - RECOMMENDED TIGHTENING TORQUE EMPFÖHLENES ANZUGSMOMENT

- Takımı Sıkmadan Önce Aşağıdaki Bilgileri Okuyunuz.  
*Read below information before tightening the tool.*  
*Bitte lesen Sie die nachfolgenden Informationen bevor Sie das Werkzeug spannen.*
- Vidalı Takımın Vida Ölçüsü ile Tutucunun İç Vida Ölçüsünü Sıkmadan Önce Kontrol Ediniz.  
*Check screw set's the screw size and together with mounting arbor inner dimension of screws.*  
*Prüfen Sie, ob das Gewinde vom Werkzeug mit dem Gewinde in der Verlängerung identisch ist.*
- Takımı Tutucuya Sıkarken Tablodaki İlgili Değerlere Göre İşlem Yapınız.  
*When tightening head to an arbor, follow the related tightening torque in the table.*  
*Wenn Sie den Einschraubfräser festziehen, beachten Sie bitte die angegebenen Anzugsmomente.*

Vida Screw Schraube	Tork Torque (N.m) Anzugsmoment (N.m)
M6	8
M8	23
M10	46
M12	80
M16	90





## FREZELEME İŞLEMİNDE DEVİR ve İLERLEME HESABI

Vc.	S	D	F	Z	fz	FORMÜLLER
Kesme Hızı (Uç Kutusunun Arkasından Okuyunuz)	İş Mili Devir Sayısı	Tarama Kafası Çapı	İlerleme	Tarama Kafası Ağız Sayısı	Diş Başına Düşen İlerleme Miktarı (Uç Kutusunun Arkasından Okuyunuz)	Devir Hesabı : $S=(Vc \times 1000) / (3,14 \times D)$ İlerleme Hesabı : $F=S \times Z \times fz$

**Örnek :** D=50 mm çapında, Z=5 ağızlı tarama kafası ile frezeleme yapacağız. Kesici uç kutusunun arkasında kesme hızı Vc=200m/dk. olarak verilmiş olsun. Tezgaha girilecek devri hesaplayalım: **Vc=200 m/dk. D=50 mm S =** Öncelikle Kesme Hızı 1000 ile çarpılır, çıkan sonuç 3,14 sayısına bölünür, buradan çıkan sonuç da tarama kafası çapına bölünür.

$S=200 \times 1000 = 200000 \rightarrow 200000/3,14=63663 \rightarrow 63663/50=1273$  devir **S=1273 dev/dakika** devri bulduktan sonra ilerlemeyi bulalım: **Z=5** ağızlı tarama kafası olsun **fz=0,12** olarak uç kutusunun arkasından okunmuş olsun F= yukarıda bulmuş olduğumuz devir sayısı ile ağız sayısı çarpılır, çıkan sonuç diş başına düşen ilerleme miktarı ile çarpılır.

$F=1273 \times 5 = 6365 \rightarrow 6365 \times 0,12 = 763$   $F=763$  mm/dakika

Tezgaha girilecek olan devir = S 1273 Tezgaha girilecek olan ilerleme : **F 763 ortalama değerdir.**

**Not:** Vc ve fz değerlerinin uç kutusunun arkasında verilmiş olması gerekir. Eğer bu değerler uç kutusunun üzerinde yoksa, kesici ucun katalogundan bulunuz. İşleyeceğiniz malzeme çelik ise P, paslanmaz çelik ise M, dökme demir ise K bölümünde yazılı olan Vc ve fz değerlerini okuyun.

## CALCULATING SPINDLE SPEED and FEED RATE FOR MILLING PROCESS

Vc.	S	D	F	Z	fz	FORMULAS
Cutting Speed (Please read from the back- side of cutting insert box)	Spindle Revolution rpm	Milling Tool Diameter	Feed Rate	Number of Effective Tooth	Feed Per Tooth (Please Read From The Back Side of Cutting Insert Box)	Calculation of Revolution : $S=(Vc \times 1000) / (3,14 \times D)$ Feed Rate Calculation : $F=S \times Z \times fz$

For Example : We will make milling with milling tool whose diameter is D 50 mm, whose teeth number is Z=5. The spindle revolution was written as Vc=200m/mn at the back side of cutting insert box. Let's calculate the revolution that should be entered to the milling machine : Vc=200 m/mn D=50 mm  
S = Firstly Cutting Speed is multiplied with 1000, the result should be divided by 3.14 , the last result should be divided by diameter of milling tool.

$S = 200 \times 1000 = 200000 \rightarrow 200000/3,14 = 63663 \rightarrow 63663/50 = 1273$  rev  $S=1273$  rev / mn

After finding spindle revolution, let's find feed rate : milling tool with Z=5 teeth and we read fz=0,12 from the back side of cutting insert box.

F = Tooth number should be multiplied with revolution, the result should be multiplied with feed per tooth.

$F = 1273 \times 5 = 6365 \rightarrow 6365 \times 0,12 = 763$   $F = 763$  mm / mn

Revolution that should be entered to the milling machine = S 1273 Feed Rate that should be entered to the milling machine = F 763 average value.

P.S : The values Vc and fz has to be written at the back side of the cutting insert. If these values were not written on the cutting insert box, please find them from cutting insert catalogue. If the material that you will work is steel, please read Vc and fz values that were written on the part P, if it is stainless steel please read from the part M, if it is cast iron please read from the part K.

## BERECHNUNG VON DREHZAHL UND VORSCHUB FÜR FRÄSWERKZEUGE

Vc.	S	D	F	Z	fz	Formeln
Schnittgeschwindigkeit (finden Sie z.B. auf der Verpackung der Wendeschneidplatte)	Spindel Drehzahl	Fräswerkzeug Durchmesser	Vorschubgeschwindigkeit	Anzahl der effektiven Zähne	Vorschub pro Zahn (finden Sie z.B. auf der Verpackung der Wendeschneidplatte)	Berechnung der Drehzahl: $n=(vc \times 1000) / (3,14 \times D)$ Vorschubberechnung: $F=n \times Z \times fz$

Beispiel: Fräswerkzeug mit D=50 mm und Z=5. Schnittgeschwindigkeit vc=200 m/min. (laut Wendeschneidplattenverpackung).

Berechnung der Drehzahl:  $n=200 \text{ m/min.} \times 1000 = 200000 / 3,14=63694 / 50 \text{ mm} = 1273$  Umdr./min.

Berechnung des Vorschubs: Ermittlung von fz (finden Sie z.B. auf der Verpackung der Wendeschneidplatte), für das Berechnungsbeispiel

$fz=0,12 \text{ mm}$   $F = n \times Z \times fz = 1273 \times 5 \times 0,12 = 763 \text{ mm/min.}$  D.h., Sie stellen an der Maschine folgende Werte ein: Drehzahl n = 1273 Umdr./min., Vorschub F = 763 mm/min.

P.S.: Die Werte für vc und fz finden Sie auf der Rückseite der Wendeschneidplattenverpackung. Sollten diese Werte dort nicht stehen, können Sie diese auch im Wendeschneidplattenkatalog finden. Für Stahl wählen Sie für vc und fz bitte die Werte aus dem Bereich P, für rostfreien Stahl aus dem Bereich M und für Guss aus dem Bereich K.

## Gövde Malzemesine Göre Delik İçi Kater Uygulama Kılavuzu

### Internal Boring Bars Application Guide, Related to Body Material

#### Anwendungshinweise für Bohrstangen, abhängig vom Bohrstangen-Material

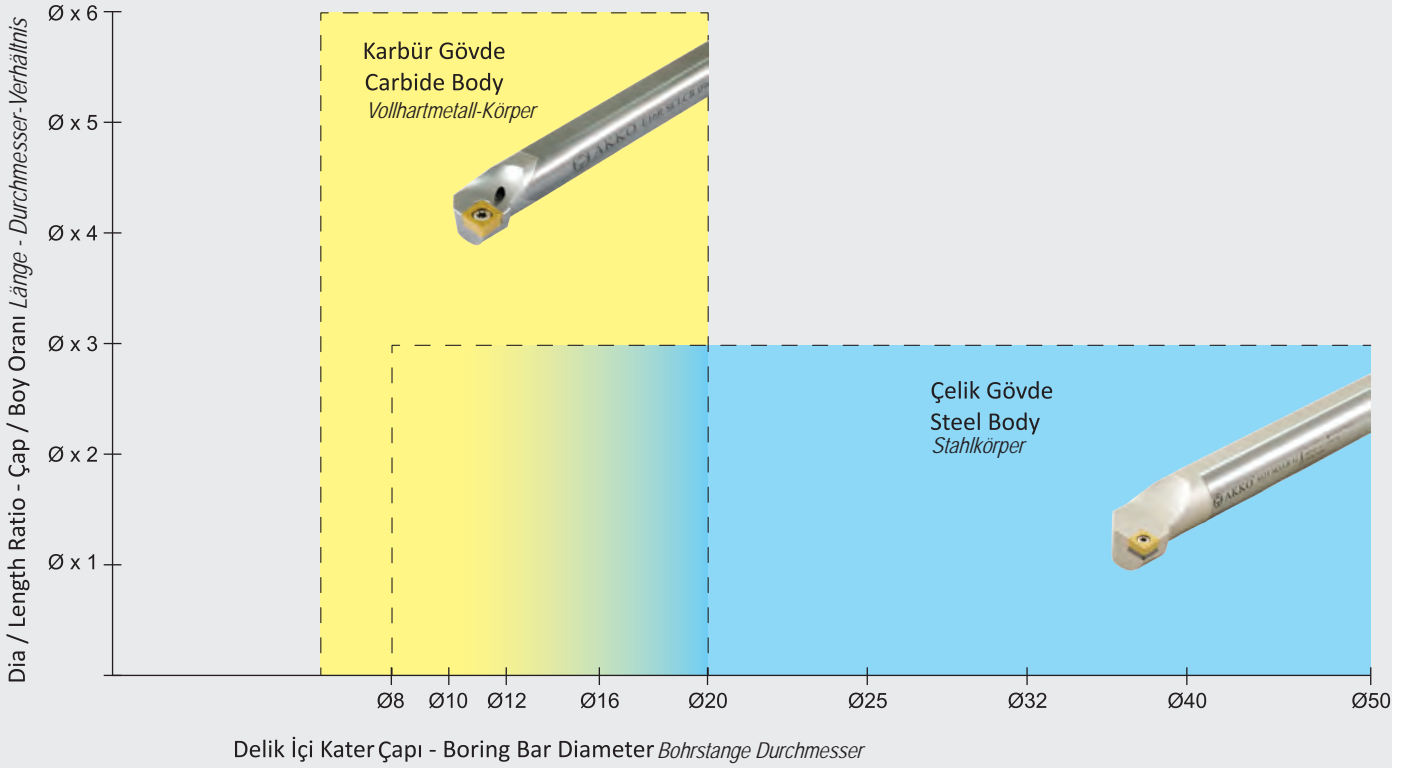

## T Kanal Freze Kullanım ve Ön Hazırlama Kılavuzu

### Application Guide For T-Slot Milling

#### Anwendungshinweise für T-Nutenfräser

T kanal frezelemede talaşın rahat boşaltılması için iş parçası resimde gösterildiği şekilde işlenmelidir.

Örnek: ATSM90-CC06- D32X10-W25- L100-Z04 kodlu T freze ile kanal açmadan önce, takımın boğazının çalışacağı kısmın parmak freze ile işlenmesi gerekir. Bu durumda kanalın tamamen işlenmesi çok yanlıştır. Tabanda ( $0.8 \times b = 0.8 \times 10$ ) 8mm işlenmeden bırakılmalıdır. Bu bölgeyi T frezenin işlemesi, takımın daha sağlıklı çalışması açısından gereklidir.

İşlenen kanallarda yumuşak kesim için talaşlar uzaklaştırılmış olmalıdır.

When T slot machining steel, the workpiece must be machined as shown in the drawing to ensure smooth chip evacuation.

Example: Before slotting with the T - slot milling cutter - code ATSM90-CC06-D32X10-W25-L100-Z04,

The area of the neck of the tools to be worked and must be machined by End-Mill.

In this case, it is very wrong to machining the slot completely.

Bottom area ( $0.8 \times b = 0.8 \times 10$ ) should be left 8 mm without machining.

This area's operation must be machined by the T - slot milling cutter which is also necessary for the healthier work of the tool holder. Slots to be machined must be free from chips for smooth machining.

Beim Einsatz von T-Nutenfräsern muss das Werkstück so bearbeitet werden wie es in der Zeichnung dargestellt ist, um einen problemlosen Spänetransport zu gewährleisten.

Bespiel: Einsatz des T-Nutenfräasers ATSM90-CC06-D32X10-W25-L100-Z04

Die Aussparung für den Halsbereich des T-Nutenfräasers muss mit einem Schaftfräser vorgearbeitet werden. Bitte beachten Sie dabei, dass die Aussparung nicht komplett bis auf den Grund gefräst wird, sondern eine Bodenstärke von  $0,8 \times b$  (im Beispiel  $0,8 \times 10 \text{ mm} = 8 \text{ mm}$ ) im Werkstück verbleibt.

Dieser Bereich soll mit dem T-Nutenfräser bearbeitet werden, da dies für die Stabilität und Standzeit des Werkzeugs besser ist.

In der zu bearbeitenden Nut sollten keine Späne mehr vorhanden sei.

### KULLANIM İÇİN UYARI

#### CAUTION FOR USE

Bitte beachten Sie!

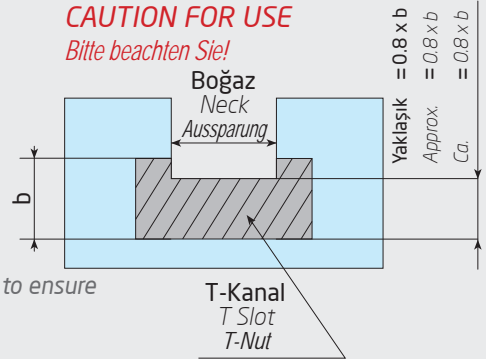

**α = 5 Kat Dayanıklılık****α = 5 Times Long Life****α = 5-Fache Standzeit****Alfa Kaplamanın Avantajları***Alpha Coating Advantages**Vorteile der Alpha-Beschichtung*

- **Yüksek aşınma direnci**  
High resistance to abrasion  
Hoher Verschleißschutz
- **Yüksek yüzey sertliği**  
**750-800 Vickers**  
High surface hardness  
750-800 Vickers  
Hohe Oberflächenhärte von 750-800 HV
- **Temperlemeye karşı yüksek direnç**  
High resistance to tempering  
Hoher Temperaturwiderstand
- **Yüksek yorulma mukavemeti**  
High fatigue strength  
Hohe Dauerfestigkeit
- **Yüksek çizik ve çentik direnci**  
High scratch and impact resistance  
Hoher Kratz-und Stoß-Widerstand
- **Paslanmaz olmayan çelikler için daha yüksek korozyon direnci**  
Resistant to corrosion of non-stainless steel  
Korrosionsschutz

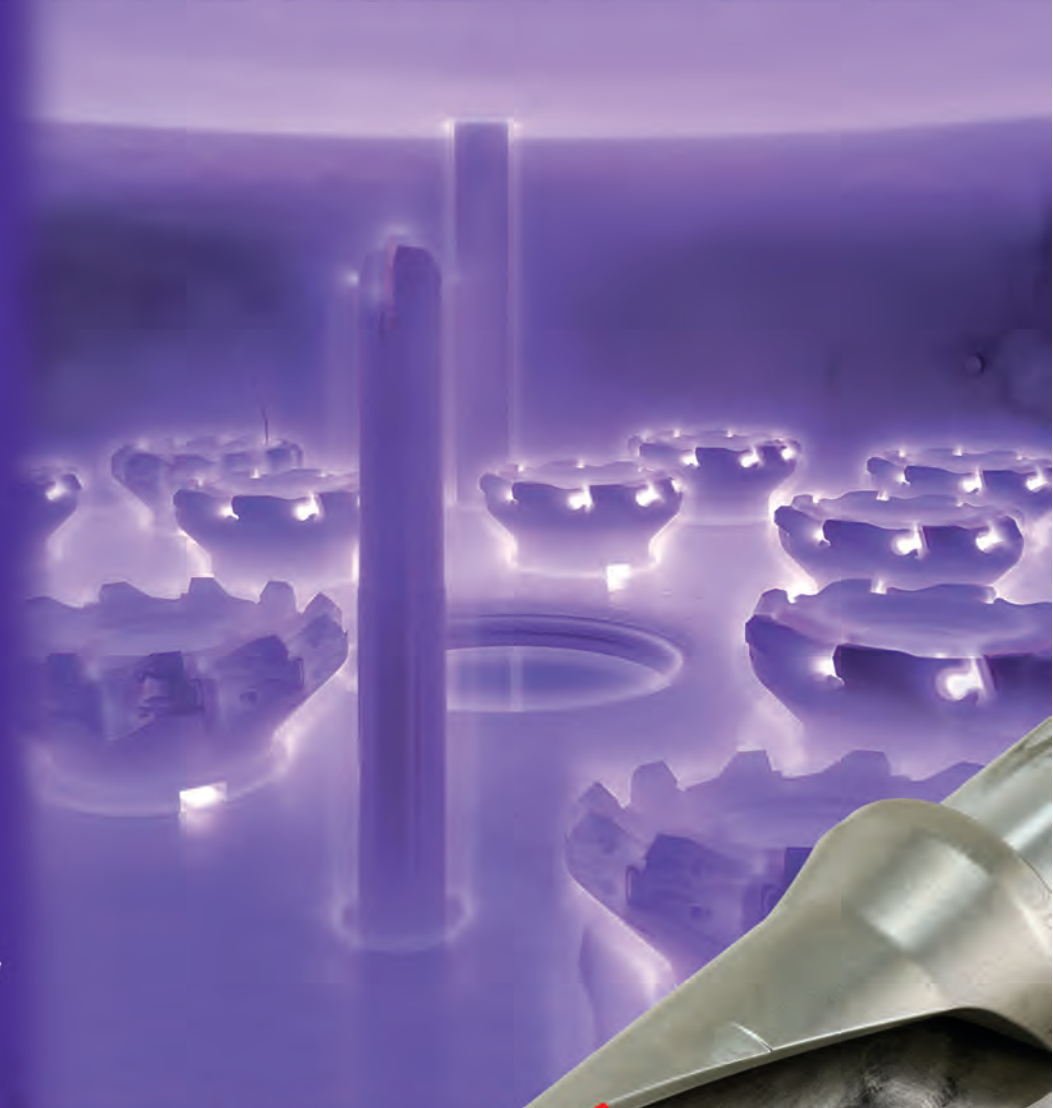

takımınız neden  
**daha uzun ömürlü**  
olmasın?...

**longer tool life...****längere Werkzeug-Standzeit**

**α Çevre Dostudur. α is friend of environment.**  
**α ist umweltfreundlich.**

**İnsan sağlığı açısından zararlı değildir. Is not harmful to human health.**  
**Nicht gesundheitsschädlich.**

**Gaz ve diğer atıkları çevreyi kirlilemez. Gas and other wastes will not pollute the environment.**  
**Umweltverträgliches Beschichtungsverfahren.**

ALTLIKLAR / SHIMS / UNTERLAGE

ÜRÜN RESMİ/PICTURE BILD	ÜRÜN KODU/CODE BEZEICHNUNG	ÜRÜN DETAYI / PRODUCT DETAIL PRODUKTBESCHREIBUNG	
	<b>AATN-2-0001</b>	S-SİSTEM için / For S-SYSTEM / FÜR S-SYSTEM	TCMT 16 ALTLIK / SHIM / UNTERLAGE
	<b>AATN-2-0002</b>	T-M SİSTEM için / For T-M SYSTEM / FÜR T-M-SYSTEM	TNMG 16 ALTLIK / SHIM / UNTERLAGE
	<b>AATN-3-0025</b>	C-SİSTEM için / For C-SYSTEM / FÜR C-SYSTEM	TNGN 16 ALTLIK / SHIM / UNTERLAGE
	<b>AATN-3-0015</b>	P-SİSTEM için / For P-SYSTEM / FÜR P-SYSTEM	TNMG 16 ALTLIK / SHIM / UNTERLAGE
	<b>AATN-2-0020</b>	T-M-P SİSTEM için / For T-M SYSTEM / FÜR T-M-P-SYSTEM	TNMG 22 ALTLIK / SHIM / UNTERLAGE
	<b>AATN-2-0004</b>	DİŞ VİDA 16 ALTLIK / For THREADING 16 SHIM / 16 SHIM / GEWINDE 16 UNTERLAGE	
	<b>ATS-16E</b>	DİŞ VİDA 22 ALTLIK / For THREADING 22 SHIM / GEWINDE 22 UNTERLAGE	
	<b>ATS-16I</b>	DİŞ VİDA 16, DİŞ ÇAP SAĞ - DELİK İÇİ SOL ALTLIK / For THREADING SYSTEM 16 SHIM, EXTERNAL RIGHT-INTERNAL LEFT / FÜR 16 ER-GEWINDEPLATTE, EXTERN RECHTS- INTERN LINKS	
	<b>ATS-16I</b>	DİŞ VİDA 16, DİŞ ÇAP SOL - DELİK İÇİ SAĞ ALTLIK / For THREADING SYSTEM 16 SHIM, EXTERNAL LEFT-INTERNAL RIGHT / FÜR 16 ER-GEWINDEPLATTE, EXTERN LINKS- INTERN RECHTS	
	<b>ATS-22E</b>	DİŞ VİDA 22, DİŞ ÇAP SAĞ - DELİK İÇİ SOL ALTLIK / For THREADING SYSTEM 22 SHIM, EXTERNAL RIGHT-INTERNAL LEFT / FÜR 22 ER-GEWINDEPLATTE, EXTERN RECHTS- INTERN LINKS	
	<b>ATS-22I</b>	DİŞ VİDA 22, DİŞ ÇAP SOL - DELİK İÇİ SAĞ ALTLIK / For THREADING SYSTEM 22 SHIM, EXTERNAL LEFT-INTERNAL RIGHT / FÜR 22 ER-GEWINDEPLATTE, EXTERN LINKS- INTERN RECHTS	
	<b>ATS-27E</b>	DİŞ VİDA 27, DİŞ ÇAP SAĞ - DELİK İÇİ SOL ALTLIK / For THREADING SYSTEM 27 SHIM, EXTERNAL RIGHT-INTERNAL LEFT / FÜR 27 ER-GEWINDEPLATTE, EXTERN RECHTS- INTERN LINKS	
	<b>ATS-27I</b>	DİŞ VİDA 27, DİŞ ÇAP SOL - DELİK İÇİ SAĞ ALTLIK / For THREADING SYSTEM 27 SHIM, EXTERNAL LEFT-INTERNAL RIGHT / FÜR 27 ER-GEWINDEPLATTE, EXTERN LINKS- INTERN RECHTS	
	<b>ATS-27I</b>	DİŞ VİDA 27, DİŞ ÇAP SOL - DELİK İÇİ SAĞ ALTLIK / For THREADING SYSTEM 27 SHIM, EXTERNAL LEFT-INTERNAL RIGHT / FÜR 27 ER-GEWINDEPLATTE, EXTERN LINKS- INTERN RECHTS	
	<b>AACN-2-0001</b>	S-SİSTEM için / For S-SYSTEM / FÜR S-SYSTEM	CCMT 09 ALTLIK / SHIM / UNTERLAGE
	<b>AACN-2-0002</b>	T-SİSTEM için / For T-SYSTEM / FÜR T-SYSTEM	CNMG 09 ALTLIK / SHIM / UNTERLAGE
	<b>AACN-2-0002</b>	P-SİSTEM için / For P-SYSTEM / FÜR P-SYSTEM	CNMG 09 ALTLIK / SHIM / UNTERLAGE
	<b>AACN-2-0003</b>	S-SİSTEM için / For S-SYSTEM / FÜR S-SYSTEM	CCMT 12 ALTLIK / SHIM / UNTERLAGE
	<b>AACN-3-0001</b>	T-M-P SİSTEM için / For T-M-P SYSTEM / FÜR T-M-P-SYSTEM	CNMG 12 ALTLIK / SHIM / UNTERLAGE
	<b>AACN-3-0002</b>	C-SİSTEM için / For C-SYSTEM / FÜR C-SYSTEM	CNGN 12 ALTLIK / SHIM / UNTERLAGE
	<b>AACN-3-0002</b>	T-P SİSTEM için / For T-P SYSTEM / FÜR T-P-SYSTEM	CNMG 16 ALTLIK / SHIM / UNTERLAGE
	<b>AACN-3-0003</b>	T-P SİSTEM için / For T-P SYSTEM / FÜR T-P-SYSTEM	CNMG 19 ALTLIK / SHIM / UNTERLAGE
	<b>AACN-3-0008</b>	T-P SİSTEM için / For T-P SYSTEM / FÜR T-P-SYSTEM	CNMG 25 ALTLIK / SHIM / UNTERLAGE
	<b>AACN-3-0008</b>	T-P SİSTEM için / For T-P SYSTEM / FÜR T-P-SYSTEM	CNMG 25 ALTLIK / SHIM / UNTERLAGE
	<b>AAWN-2-0003</b>	T-M-P SİSTEM için / For T-M-P SYSTEM / FÜR T-M-P-SYSTEM	WNMG 08 KALIN ALTLIK / THICK SHIM / DICKE UNTERLAGE
	<b>AAWN-3-0001</b>	T-M-P SİSTEM için / For T-M-P SYSTEM / FÜR T-M-P-SYSTEM	WNMG 08 ALTLIK / SHIM / UNTERLAGE
	<b>AAWN-3-0001</b>	T-M-P SİSTEM için / For T-M-P SYSTEM / FÜR T-M-P-SYSTEM	WNMG 06 ALTLIK / SHIM / UNTERLAGE
	<b>AAWN-SW317</b>	T-M-P SİSTEM için / For T-M-P SYSTEM / FÜR T-M-P-SYSTEM	WNMG 06 ALTLIK / SHIM / UNTERLAGE
	<b>AKS-16L</b>	C-SİSTEM için / For C-SYSTEM / FÜR C-SYSTEM	KNUX-L 16 ALTLIK / SHIM / UNTERLAGE
	<b>AKS-16R</b>	C-SİSTEM için / For C-SYSTEM / FÜR C-SYSTEM	KNUX-R 16 ALTLIK / SHIM / UNTERLAGE
	<b>AASD-3-0001</b>	S-SİSTEM FREZELEME için / For S-SYSTEM MILLING / S-SYSTEM FÜR FRÄSER	SDMT 12 ALTLIK / SHIM / UNTERLAGE
	<b>AASE-3-0001</b>	S-SİSTEM FREZELEME için / For S-SYSTEM MILLING / S-SYSTEM FÜR FRÄSER	SEMT 13 ALTLIK / SHIM / UNTERLAGE
	<b>AASN-2-0001</b>	S-SİSTEM için / For S-SYSTEM / FÜR S-SYSTEM	SCMT 09 ALTLIK / SHIM / UNTERLAGE
	<b>AASN-2-0002</b>	P-SİSTEM için / For P-SYSTEM / FÜR P-SYSTEM	SNMG 09 ALTLIK / SHIM / UNTERLAGE
	<b>AASN-2-0004</b>	S-SİSTEM için / For S-SYSTEM / FÜR S-SYSTEM	SCMT 12 ALTLIK / SHIM / UNTERLAGE
	<b>AASN-3-0004</b>	T-P SİSTEM için / For T-P SYSTEM / FÜR T-P-SYSTEM	SNMG 12 ALTLIK / SHIM / UNTERLAGE
	<b>AASN-3-0004</b>	C-SİSTEM için / For C-SYSTEM / FÜR C-SYSTEM	SNGN 12 ALTLIK / SHIM / UNTERLAGE
	<b>AASN-3-0023</b>	T-P SİSTEM için / For T-P SYSTEM / T-P TMT	SNMG 15 ALTLIK / SHIM / UNTERLAGE
	<b>AASN-3-0005</b>	T-P SİSTEM için / For T-P SYSTEM / FÜR T-P-SYSTEM	SNMG 19 ALTLIK / SHIM / UNTERLAGE
	<b>AASN-3-0020</b>	T-P SİSTEM için / For T-P SYSTEM / FÜR T-P-SYSTEM	SNMG 25 ALTLIK / SHIM / UNTERLAGE
	<b>AASN-20020</b>	PSDNN KARTUŞ için / For PSDNN CARTRIDGE / FÜR PSDNN-KURZDREHHALTER	SNMG 12 ALTLIK / SHIM / UNTERLAGE
	<b>AASN-20020</b>	PSDNN KARTUŞ için / For PSDNN CARTRIDGE / FÜR PSDNN-KURZDREHHALTER	SNMG 12 ALTLIK / SHIM / UNTERLAGE
	<b>AADN-2-0001</b>	S-SİSTEM için / For S-SYSTEM / FÜR S-SYSTEM	DCMT 11 ALTLIK / SHIM / UNTERLAGE
	<b>AADN-SD317</b>	T-SİSTEM için / For T-SYSTEM / FÜR T-SYSTEM	DNMG 11 ALTLIK / SHIM / UNTERLAGE
	<b>AADN-SD317</b>	P-SİSTEM için / For P-SYSTEM / FÜR P-SYSTEM	DNMG 11 ALTLIK / SHIM / UNTERLAGE
	<b>AADN-3-0001</b>	T-M-P SİSTEM için / For T-M-P SYSTEM / FÜR T-M-P-SYSTEM	DNMG 15 ALTLIK / SHIM / UNTERLAGE
	<b>AADN-3-0001</b>	C-SİSTEM için / For C-SYSTEM / FÜR C-SYSTEM	DNGN 15 ALTLIK / SHIM / UNTERLAGE
	<b>AADN-2-0003</b>	T-SİSTEM için / For T-SYSTEM / FÜR T-SYSTEM	DNMG 15 KALIN ALTLIK / THICK SHIM / DICKE UNTERLAGE
	<b>AAVN-2-0002</b>	S-SİSTEM için / For S-SYSTEM / FÜR S-SYSTEM	VBMT 16, VCMT 16 ALTLIK / SHIM / UNTERLAGE
	<b>AAVN-2-0003</b>	T-SİSTEM için / For T-SYSTEM / FÜR T-SYSTEM	VNMG 16 ALTLIK / SHIM / UNTERLAGE
	<b>AAVN-2-0003</b>	S-SİSTEM için / For S-SYSTEM / FÜR S-SYSTEM	VCMT 22 ALTLIK / SHIM / UNTERLAGE
	<b>AARC-3-0001</b>	C-SİSTEM için / For C-SYSTEM / FÜR C-SYSTEM	RCGX 06 ALTLIK / SHIM / UNTERLAGE
	<b>AARC-3-0001</b>	C-SİSTEM için / For C-SYSTEM / FÜR C-SYSTEM	RCGX 09 ALTLIK / SHIM / UNTERLAGE
	<b>AARC-3-0002</b>	C-SİSTEM için / For C-SYSTEM / FÜR C-SYSTEM	RCGX 09 ALTLIK / SHIM / UNTERLAGE
	<b>AARC-3-0003</b>	C-SİSTEM için / For C-SYSTEM / FÜR C-SYSTEM	RCGX 12 ALTLIK / SHIM / UNTERLAGE
	<b>AARC-3-0003</b>	C-SİSTEM için / For C-SYSTEM / FÜR C-SYSTEM	RCGX 12 ALTLIK / SHIM / UNTERLAGE

BASKI PABUÇLARI / CLAMPS / SPANNSPRATZE

ÜRÜN RESMİ/PICTURE BILD	ÜRÜN KODU/CODE BEZEICHNUNG	ÜRÜN DETAYI / PRODUCT DETAIL PRODUKTBESCHREIBUNG
	<b>ATK-01</b>	T-SİSTEM için / For T-SYSTEM / FÜR T-SYSTEM DNMG 11, WNMG 06, TNMG 16, CNMG 09 BASKI PABUCU / CLAMP / PRATZE
	<b>ATK-02</b>	T-SİSTEM için / For T-SYSTEM / FÜR T-SYSTEM CNMG 12, WNMG 08, TNMG 22, DNMG 15, SNMG 12 BASKI PABUCU / CLAMP / PRATZE
	<b>ATK-03</b>	T-SİSTEM için / For T-SYSTEM / FÜR T-SYSTEM VNMG 16 BASKI PABUCU / CLAMP / PRATZE
	<b>ATK-04</b>	T-SİSTEM için / For T-SYSTEM / FÜR T-SYSTEM CNMG 16, SNMG 15 BASKI PABUCU / CLAMP / PRATZE
	<b>ATKH-01-R</b>	T-SİSTEM için / For T-SYSTEM / FÜR T-SYSTEM İÇTEN SOĞUTMA KANALLI BASKI PABUCU / WITH COOLANT TOOLS / INNENKÜHLUNG
	<b>ATKH-02-L</b>	T-SİSTEM için / For T-SYSTEM / FÜR T-SYSTEM İÇTEN SOĞUTMA KANALLI BASKI PABUCU / WITH COOLANT TOOLS / INNENKÜHLUNG
	<b>ATKH-03-R</b>	T-SİSTEM için / For T-SYSTEM / FÜR T-SYSTEM İÇTEN SOĞUTMA KANALLI BASKI PABUCU / WITH COOLANT TOOLS / INNENKÜHLUNG
	<b>ATKH-04-L</b>	T-SİSTEM için / For T-SYSTEM / FÜR T-SYSTEM İÇTEN SOĞUTMA KANALLI BASKI PABUCU / WITH COOLANT TOOLS / INNENKÜHLUNG
	<b>ATKH-05-R</b>	T-SİSTEM için / For T-SYSTEM / FÜR T-SYSTEM İÇTEN SOĞUTMA KANALLI BASKI PABUCU / WITH COOLANT TOOLS / INNENKÜHLUNG
	<b>ATKH-06-L</b>	T-SİSTEM için / For T-SYSTEM / FÜR T-SYSTEM İÇTEN SOĞUTMA KANALLI BASKI PABUCU / WITH COOLANT TOOLS / INNENKÜHLUNG
	<b>ATKH-07-R</b>	T-SİSTEM için / For T-SYSTEM / FÜR T-SYSTEM İÇTEN SOĞUTMA KANALLI BASKI PABUCU / WITH COOLANT TOOLS / INNENKÜHLUNG
	<b>ATKH-08-L</b>	T-SİSTEM için / For T-SYSTEM / FÜR T-SYSTEM İÇTEN SOĞUTMA KANALLI BASKI PABUCU / WITH COOLANT TOOLS / INNENKÜHLUNG
	<b>ATKH-09-R</b>	T-SİSTEM için / For T-SYSTEM / FÜR T-SYSTEM İÇTEN SOĞUTMA KANALLI BASKI PABUCU / WITH COOLANT TOOLS / INNENKÜHLUNG
	<b>ATKH-10-L</b>	T-SİSTEM için / For T-SYSTEM / FÜR T-SYSTEM İÇTEN SOĞUTMA KANALLI BASKI PABUCU / WITH COOLANT TOOLS / INNENKÜHLUNG
	<b>AMK-01</b>	M-SİSTEM için / For M-SYSTEM / FÜR M-SYSTEM WNMG 06 BASKI PABUCU / CLAMP / PRATZE
	<b>AMK-02</b>	M-SİSTEM için / For M-SYSTEM / FÜR M-SYSTEM DELİK İÇİ / INTERNAL Ø20 TNMG 16, Ø25 MT-NR/L 16 BASKI PABUCU / CLAMP / PRATZE
	<b>AMK-03</b>	M-SİSTEM için / For M-SYSTEM / FÜR M-SYSTEM DNMG 11, CNMG 12 BASKI PABUCU / CLAMP / PRATZE
	<b>AMK-04</b>	M-SİSTEM için / For M-SYSTEM / FÜR M-SYSTEM DNMG 15, TNMG 16-22 BASKI PABUCU / CLAMP / PRATZE
	<b>AMK-05</b>	M-SİSTEM için / For M-SYSTEM / FÜR M-SYSTEM WNMG 08 BASKI PABUCU / CLAMP / PRATZE
	<b>AMK-07</b>	M-SİSTEM için / For M-SYSTEM / FÜR M-SYSTEM S20R MCLNR/L BASKI PABUCU / CLAMP / PRATZE
	<b>AMK-08</b>	M-SİSTEM için / For M-SYSTEM / FÜR M-SYSTEM TNMG 22 BASKI PABUCU / CLAMP / PRATZE
	<b>ACK-01-R</b>	C-SİSTEM için / For C-SYSTEM / FÜR C-SYSTEM KNUX-R BASKI PABUCU / CLAMP / PRATZE
	<b>ACK-02-L</b>	C-SİSTEM için / For C-SYSTEM / FÜR C-SYSTEM KNUX-L BASKI PABUCU / CLAMP / PRATZE
	<b>ACK-03</b>	C-SİSTEM için / For C-SYSTEM / FÜR C-SYSTEM 154.91 DIŞ ÇAP ve DELİK İÇİ/EXTERNAL and INTERNAL/ AUBEN-DREHHALTER Ø25-Ø32 / PABUCU / CLAMP / PRATZE
	<b>ACK-04</b>	P-C-SİSTEM için / For P-C-SYSTEM / FÜR P-C-SYSTEM CTFPR KARTUŞ BASKI PABUCU / CARTRIDGE CLAMP / PRATZE FÜR KASSETTE
	<b>ACK-05</b>	P-C-SİSTEM için / For P-C-SYSTEM / FÜR P-C-SYSTEM FREZELEME ve DIŞ VIDA AÇMA TAKIMLARINA GÖRE İLAVE BASKI PABUCU ADDITIONAL LITTLE CLAMP for MILLING and THREADING CLAMP KLEINE ZUSATZKLEMME FÜR FRÄSER UND GEWINDEWERKZEUGE
	<b>ACK-06</b>	C-SİSTEM için / For C-SYSTEM / FÜR C-SYSTEM 154.91 DELİK İÇİ / INTERNAL / INNEN Ø16-Ø20 BASKI PABUCU / CLAMP / PRATZE
	<b>ACK-07</b>	C-SİSTEM için / For C-SYSTEM / FÜR C-SYSTEM SERAMİK CNGN, SNGN, DNGN YEDEK TAKIMI SPARE PART SET of CERAMIC CNGN, SNGN, DNGN ERSATZTEILSATZ FÜR KERAMIK CNGN, SNGN, DNGN
	<b>ACK-08</b>	C-SİSTEM için / For C-SYSTEM / FÜR C-SYSTEM SERAMİK TNGN, YEDEK TAKIMI SPARE PART SET of CERAMIC TNGN ERSATZTEILSATZ FÜR KERAMİK TNGN
	<b>ACK-09</b>	P-SİSTEM için / For P-SYSTEM / FÜR P-SYSTEM CNMG 16-19, SNMG 15-19 İLAVE BÜYÜK BASKI PABUCU ADDITIONAL BIG CLAMP / ZUSÄTZLICHE GROSSE KLEMMME
	<b>ACK-10</b>	C-SİSTEM FREZELEME için / For C-SYSTEM MILLING C-SYSTEM FÜR FRÄSER SPKN 12, Ø50-Ø63 TPKN 16 BASKI PABUCU / CLAMP / PRATZE (M8x8)
	<b>ACK-11</b>	C-SİSTEM FREZELEME için / For C-SYSTEM MILLING C-SYSTEM FÜR FRÄSER Ø80-Ø100 TPKN 16-TPKN 22, OFKR 07, HNM 09 BASKI PABUCU / CLAMP / PRATZE (M8x10)
	<b>ACK-12</b>	C-SİSTEM için / For C-SYSTEM / FÜR C-SYSTEM CTSPR KARTUŞ BASKI PABUCU / CARTRIDGE CLAMP
	<b>ACK-15</b>	S-SİSTEM FREZELEME için / For S-SYSTEM MILLING S-SYSTEM FÜR FRÄSER RD.. 10-12 BASKI PABUCU / CLAMP / PRATZE
	<b>ACK-19</b>	S-SİSTEM FREZELEME için / For S-SYSTEM MILLING S-SYSTEM FÜR FRÄSER WD0805D BASKI PABUCU / CLAMP / PRATZE
	<b>ACK-21</b>	C-SİSTEM için / For C-SYSTEM / FÜR C-SYSTEM SN.. 1204.. BASKI PABUCU / CLAMP / PRATZE
	<b>ACK-23</b>	C-SİSTEM için / For C-SYSTEM / FÜR C-SYSTEM SERAMİK DNGN 11, YEDEK TAKIMI SPARE PART SET of CERAMIC DNGN 11 ERSATZTEILSATZ FÜR KERAMİK DNGN 11
	<b>ACK-24</b>	S-SİSTEM FREZELEME için / For S-SYSTEM MILLING S-SYSTEM FÜR FRÄSER XD0806D BASKI PABUCU / CLAMP / PRATZE
	<b>ACK-26</b>	C-SİSTEM için / For C-SYSTEM / FÜR C-SYSTEM XNMG 0806.. BASKI PABUCU / CLAMP / PRATZE
	<b>ACK-27</b>	C-SİSTEM için / For C-SYSTEM / FÜR C-SYSTEM RCGX 06 BASKI PABUCU / CLAMP / PRATZE
	<b>ACK-28</b>	C-SİSTEM için / For C-SYSTEM / FÜR C-SYSTEM RCGX 09 BASKI PABUCU / CLAMP / PRATZE
	<b>ACK-29</b>	C-SİSTEM için / For C-SYSTEM / FÜR C-SYSTEM RCGX 12 BASKI PABUCU / CLAMP / PRATZE

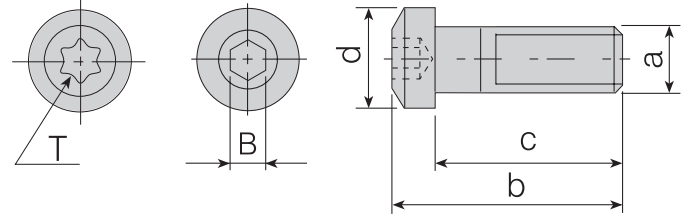

Takım Kodu Ordering Code Bestell-Bezeichnung	BASKI PABUÇ VİDALARI / CLAMP SCREWS / SCHRAUBEN FÜR PRATZEN					Ürün Detayı / Product Detail / Produkt-Details
	a (M)	b	c	d	B(T)	
AKV-01-M5X22	M5x0.8	25	22	11	3	T-SİSTEM için / For T-SYSTEM / FÜR T-SYSTEM DNMG 11, WNMG 06, TNMG 16
AKV-02-M6X22	M6x1.0	25	22	11	3	T-SİSTEM için / For T-SYSTEM / FÜR T-SYSTEM CNMG 12, WNMG 08, TNMG 22, DNMG 15, SNMG 12, VNMG 16
						M-SİSTEM için / For M-SYSTEM / FÜR M-SYSTEM TNMG 16, TNMG 22
AKV-03-M6X22	M6x1.0	24.5	22	10	3	M-SİSTEM için / For M-SYSTEM / FÜR M-SYSTEM WNMG 08
						KANAL KATERİ için / For EXTERNAL GROOVING FÜR STECHWERKZEUGE 2mm Dış Çap Kanal Kater Vidası / External Grooving Tools Screw 2 mm Schraube für Außen-Stechwerkzeuge
AKV-04-M5X17	M6x1.0	20	17	8.35	3	M-SİSTEM için / For M-SYSTEM / FÜR M-SYSTEM S20R MT-NR/L 16, S20R-S25S MWLNRL 06, S25S MDUNR/L 11-Dış Çap / External / AUBEN MWLNRL 06
AKV-05-M6X10	.....	....	...	...	.	T-SİSTEM için / For T-SYSTEM / FÜR T-SYSTEM Eski Ürün Vidası / Old Products Screws / Schraube für altes Produkt CNMG 16, SNMG 15
AKV-05-M6X25	M6x1.0	29.5	25	13.8	4	T-SİSTEM için / For T-SYSTEM / FÜR T-SYSTEM .....
AKV-06-M6X20	M6x1.0	26.5	20	10.6	4	C-SİSTEM için / For C-SYSTEM / FÜR C-SYSTEM KNUX 16
AKV-07-M6X22	M6x1.0	24	22	8.5	3	C-SİSTEM için / For C-SYSTEM / FÜR C-SYSTEM ADKT-154.91, AIKT-154.91-R/L-32
AKV-10-M6X14	M6x1.0	18	17	8.5	4	C-SİSTEM için / For C-SYSTEM / FÜR C-SYSTEM AIKT-154.91-R/L-16, AIKT-154.91-R/L-20, AIKT-154.91-R/L-25
AKV-11-M8X29	M8x1.25	34	29	11	4	C-SİSTEM için / For C-SYSTEM / FÜR C-SYSTEM TNGN 16, CNGN 12, DNGN 15, SNGN 12
AKV-17-M5X15	M5x0.8	18	15	8.5	3	M-SİSTEM için / For M-SYSTEM / FÜR M-SYSTEM S16P MWLNRL 06
AKV-19-M7X25	M7x1.0	29	25	13	4	T-SİSTEM için / For T-SYSTEM / FÜR T-SYSTEM Yeni / New / Neu CNMG 16, SNMG 15
AKV-20-M6X19	M6x1.0	22	19.5	10	3	M-SİSTEM için / For M-SYSTEM / FÜR M-SYSTEM S25S MDUNR/L 15
AKV-21-M6X18	M6x1.0	18	16	8.5	3	C-SİSTEM için / For C-SYSTEM / FÜR C-SYSTEM AIKT-154.91-R/L-25
AKV-23-M4X10	M4x0.7	12	10	7.4	15	KARTUŞ için / For CARTRIDGE / ДЛЯ КАРТРИДЖЕЙ Montaj Vidası / Mounting Screw / Befestigungsschraube
AKV-27-M6X20	M6x1.0	22	19	10	3	M-SİSTEM için / For M-SYSTEM / FÜR M-SYSTEM S25S MWLNRL 08
AKV-30-M6X22	M6x1.0	25	22	11	3	T-SİSTEM için / For T-SYSTEM / FÜR T-SYSTEM Baskı Pabucu / Wedge Clamp / Spannpratze
AKV-33-M6X22	M6x1.0	25	22.5	9.5	3	T-SİSTEM için / For T-SYSTEM / FÜR T-SYSTEM Baskı Pabucu / Wedge Clamp / Spannpratze
AKV-39-M7X21	M7x1.0	25.5	21	11.5	4	

Ürün Resmi Product Picture Produkt-Bild	SOĞUTMA NOZULU / COOLANT NOZZLE / KÜHLMITTELDÜSE	
	Ürün Kodu Product Code / Code	Ürün Detayı / Product Detail / Produkt-Details
	AN-01	SOĞUTMA NOZULU / Coolant Nozzle / KÜHLMITTELDÜSE

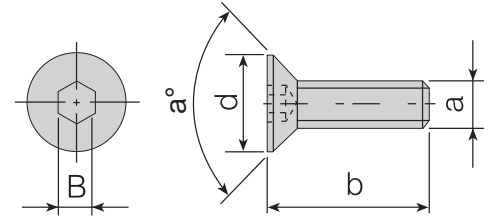

ALTLIK VIDALARI / SHIM SCREWS / SCHRAUBE FÜR UNTERLAGE

Takım Kodu Ordering Code Bestell-Bezeichnung	a (M)	b	d	B	a°	Ürün Detayı / Product Detail / Produkt-Details
AAV-01-M3x10	M3X0.5	10	5.9	2	90°	T-SİSTEM için / For T-SYSTEM / FÜR T-SYSTEM / WNMG 06, KNUX 16
AAV-02-M5X12	M5X0.8	12	7	3	56°	T-SİSTEM için / For T-SYSTEM / FÜR T-SYSTEM / CNMG 12, WNMG 08, TNMG 22, DNMG 15, SNMG 12
AAV-05-M6X15	M6X1.0	15	9	4	60°	T-SİSTEM için / For T-SYSTEM / FÜR T-SYSTEM / CNMG 16, SNMG 15
AKV-12-M5X12	M5X0.8	12	7.8	3	90°	C-SİSTEM için / For C-SYSTEM / FÜR C-SYSTEM / CTSPR Baskı Pabuç Vidası / Clamp Screw / Зажимной винт
AKV-16-M6X16	M6X1.0	16	10	4	76°	C-SİSTEM için / For C-SYSTEM / FÜR C-SYSTEM / CTFPR 13CS 16 Baskı Pabuç Vidası / Clamp Screw / Зажимной винт
AAV-13-M5X8	M5X0.8	8	7	3	56°	T-SİSTEM için / For T-SYSTEM / FÜR T-SYSTEM / S25S TSKNR/L 12, S25S TCLNR/L 12, S25S TWLNR/L 08, S25S TDUNR/L 15
AAV-14-M5X14	M5X0.8	14	8.8	3	45°	ADCR için / For ADCR / FÜR ADCR / ADCR Montaj Vidası / Mounting Screw / ADCR BEFESTIGUNGSSCHRAUBE

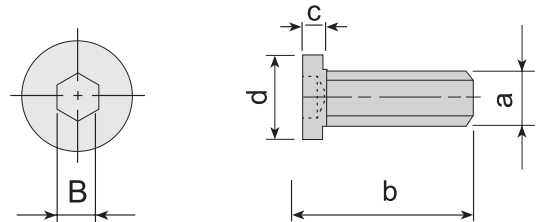

ALTLIK VIDALARI / SHIM SCREWS / SCHRAUBE FÜR UNTERLAGE

Takım Kodu Ordering Code Bestell-Bezeichnung	a (M)	b	c	d	B	Ürün Detayı / Product Detail / Produkt-Details
AAV-03-M5X12	M5X0.8	12	1.4	6	3	T-SİSTEM için / For T-SYSTEM / FÜR T-SYSTEM / TNMG 16 C-SİSTEM için / For C-SYSTEM / FÜR C-SYSTEM / TNGN 16
AAV-04-M5X12	M5X0.8	12	1.2	6.5	3	T-SİSTEM için / For T-SYSTEM / FÜR T-SYSTEM / VNMG 16, DNMG 11, CNMG 09
AAV-09-M5X9	M5X0.8	9	1.4	6	3	T-SİSTEM için / For T-SYSTEM / FÜR T-SYSTEM / S25S TCLNR/L 09, S25S TDUNR/L 11, S25S TDQNR/L 11

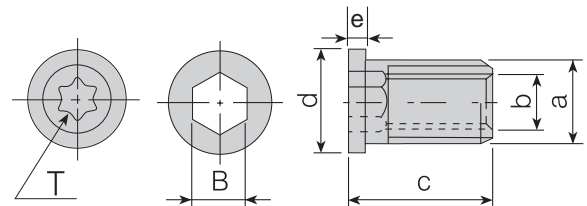

BUKSE VIDALAR / BUKSE SCREWS / SCHRAUBE FÜR UNTERLAGE

Takım Kodu Ordering Code Bestell-Bezeichnung	a (M)	b	c	d	B(T)	e	Ürün Detayı / Product Detail / Produkt-Details
AAV-06-M3.5X11	M5x0.5	M3.5x0.6	11.3	6	3.5	1.2	S-SİSTEM için / For S-SYSTEM / FÜR S-SYSTEM / CCMT 09, DCMT 11, VBMT 16, VCMT 16, TCMT 16, SCMT 09, 16 ER/L, 16 IR/L
AAV-07-M4.5X13	M6X0.75	M4.5X0.75	13	7.5	4.5	1.6	S-SİSTEM için / For S-SYSTEM / FÜR S-SYSTEM / CCMT 12, SCMT 12, 22 ER/L, 22 IR/L
AAV-08-M3.5X8	M5X0.5	M3.5x0.6	8	6	20	1.2	S-SİSTEM için / For S-SYSTEM / FÜR S-SYSTEM / Ø25 DCMT 11, Ø25-Ø32 CCMT 09, Ø25 TCMT 16, S25S-S32T SVJBR/L 16,
AAV-10-M4.5X8	M6X0.75	M4.5X0.75	8	7.5	4.5	1.05	Ø25-Ø32 CCMT 12, Ø25-Ø32 SCMT 12, SSDCN 1616 H12, SSSCR/L 1616 H12, SIR/L S25R 22
AAV-16-M3.5X8	M5X0.5	M3.5x0.6	8	6	20	1.1	S-SİSTEM için / For S-SYSTEM / FÜR S-SYSTEM / SEMT 13

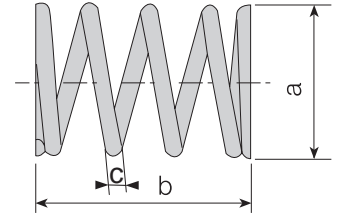
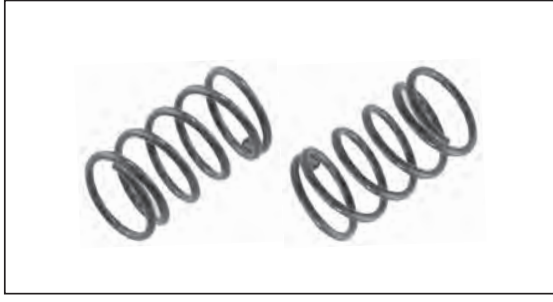

Takım Kodu Ordering Code Bestell-Bezeichnung	BASKI YAYI / CLAMP SPRING / FEDER FÜR KLEMME			Ürün Detayı / Product Detail / Produkt-Details	
	a	b	c		
AKY-01	7.7	11.2	0.9	T-SİSTEM için / For T-SYSTEM / FÜR T-SYSTEM	CNMG 12, WNMG 08, TNMG 22, DNMG 15, SNMG 12, VNMG 16
AKY-02	8.5	13.5	0.7	C-SİSTEM için / For C-SYSTEM / FÜR C-SYSTEM	KNUX 16

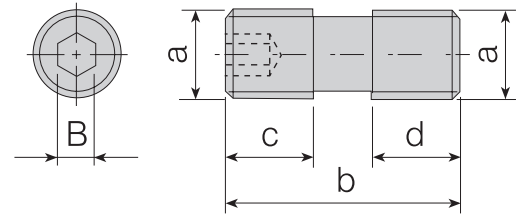

Takım Kodu Ordering Code Bestell-Bezeichnung	BASKI PABUÇ VIDALARI / CLAMP SCREWS / SCHRAUBEN FÜR PRATZEN					Ürün Detayı / Product Detail / Produkt-Details	
	a (M)	b	c	d	B		
AKV-13-M8X1X16	M8x1.0	16	6.8	6.8	4	C-SİSTEM FREZELEME için / MILLING For C- SYSTEM / FÜR C-SYSTEM	SPKN 12, Ø63 TPKN 16
AKV-14-M8X1X18	M8x1.0	18	8	8	4	C-SİSTEM FREZELEME için / MILLING For C- SYSTEM / FÜR C-SYSTEM	Ø80-Ø100 TPKN 16, Ø63-Ø315 TPKN 22
AKV-15-M8X1X20	M8x1.0	20	8.5	8.5	4	C-SİSTEM FREZELEME için / MILLING For C- SYSTEM / FÜR C-SYSTEM	OFKR 07, HNMX 09
AKV-18-M5X14	M5x0.8	15	5	6.8	2.5	C-SİSTEM FREZELEME için / MILLING For C- SYSTEM / FÜR C-SYSTEM	SN19
AKV-22-M8X1X14	M8x1.0	14	6.8	4.8	4	C-SİSTEM FREZELEME için / MILLING For C- SYSTEM / FÜR C-SYSTEM	Ø50 TPKN 16
AKV-24-M6X1X18	M6x1.0	18	7.5	7.5	3	C-SİSTEM FREZELEME için / MILLING For C- SYSTEM / FÜR C-SYSTEM	SN.. 1204
AKV-26-M6X0.75X20	M6x0.75	20	8.5	8.5	3	C-SİSTEM FREZELEME için / MILLING For C- SYSTEM / FÜR C-SYSTEM	AFM45C-XN0806
AKV-28-M10x1.5x43	M10x1.5	43	18	18	5	WNMU 0907.. Ø50 MONTAJ VIDASI / MOUNTING SCREW / BEFESTIGUNGSSCHRAUBE	WNMU 0907.. Ø50



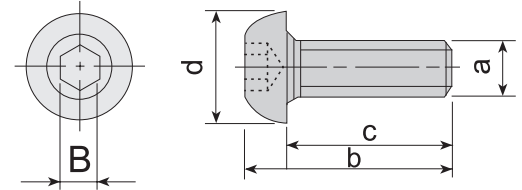

KANAL KATER ve MANTAR VİDALAR / GROOVING TOOL and CLAMP SCREWS / KLEMMSCHRAUBEN

Takım Kodu Ordering Code Bestell-Bezeichnung	a (M)	b	c	d	B	Ürün Detayı / Product Detail / Produkt-Details
1904-M8X1X20	M8X1.0	25.9	20	11.3	4	S-SİSTEM için / For S-SYSTEM / FÜR S-SYSTEM RCMT 32 Sıkma Vidası / Clamp Screw / Klemmschraube
2004-M8X1X20	M8X1.0	25.9	20	11.4	4	KANAL KATER için / For EXTERNAL GROOVING / FÜR TMNG-16, TMNG-22 BOHRSTANGE Kanal Kater Vidası / External Grooving Tools Screw / SCHRAUBEN FÜR STECHHALTER
2004-M8X20	M8X1.25	30	25	25	4	KANAL KATER için / For EXTERNAL GROOVING / FÜR TMNG-16, TMNG-22 BOHRSTANGE Eski Kanal Kater Vidası / Old External Grooving Tools Screw Alte / Schraube für Stechhalter
AKV-08-M6X12	M6x1.0	17	12	14.3	4	C-SİSTEM FREZELEME için / MILLING For C-SYSTEM / C-SYSTEM FÜR FRÄSER Baskı ve Sıkma Vidası, Mantar Vida / Clamp Screw / Klemmschraube
AKV-09-M8X18	M8X1.0	24	18	17.2	5	C-SİSTEM FREZELEME için / MILLING For C-SYSTEM / C-SYSTEM FÜR FRÄSER Baskı ve Sıkma Vidası, Mantar Vida / Clamp Screw / Klemmschraube

LEVYELER / LEVERS / KNIEHEBEL

Ürün Resmi Product Picture Produkt-Bild	Ürün Kodu Product Code / Code	Ürün Detayı / Product Detail / Produkt-Details
	APL-01	P-SİSTEM için / For P-SYSTEM / FÜR P-SYSTEM CNMG 09, DNMG 11, SNMG 09, TNMG 16, WNMG 06 LEVYESİ / LEVER / KNIEHEBE
	APL-02	P-SİSTEM için / For P-SYSTEM / FÜR P-SYSTEM CNMG 12, SNMG 12, TNMG 22, WNMG 08 LEVYESİ / LEVER / KNIEHEBE
	APL-03	P-SİSTEM için / For P-SYSTEM / FÜR P-SYSTEM DNMG 15 LEVYESİ / LEVER / KNIEHEBE
	APL-04	P-SİSTEM için / For P-SYSTEM / FÜR P-SYSTEM CNMG 16, SNMG 15 LEVYESİ / LEVER / KNIEHEBEL
	APL-05	P-SİSTEM için / For P-SYSTEM / FÜR P-SYSTEM CNMG 19, SNMG 19 LEVYESİ / LEVER / KNIEHEBEL
	APL-06	P-SİSTEM için / For P-SYSTEM / FÜR P-SYSTEM CNMG 25, SNMG 25 LEVYESİ / LEVER / KNIEHEBEL
	APL-07	P-SİSTEM için / For P-SYSTEM / FÜR P-SYSTEM S16P PCLNR/L 09 LEVYESİ / LEVER / KNIEHEBEL
	APL-08	P-SİSTEM için / For P-SYSTEM / FÜR P-SYSTEM S16P PTUNR/L 16 LEVYESİ / LEVER / KNIEHEBEL
	APL-11	P-SİSTEM için / For P-SYSTEM / FÜR P-SYSTEM TNMG 11 LEVYESİ / LEVER / KNIEHEBEL

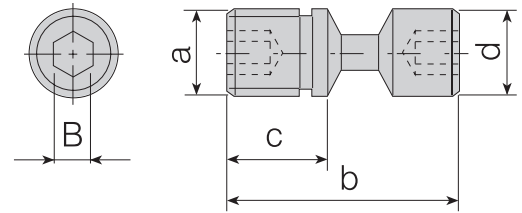

LEVYE VİDALARI / LEVER SCREWS / SCHRAUBEN FÜR KNIEHEBEL

Takım Kodu Ordering Code Bestell-Bezeichnung	a (M)	b	c	d	B	Ürün Detayı / Product Detail / Produkt-Details
ALV-01-M6X14	M6x1.0	14	10	5.85	2.5	P-SİSTEM için / For P-SYSTEM / FÜR P-SYSTEM S20R PCLNR/L 09, S20R PDUNR/L 11, S20R PDQNR/L 11, S20R PWNLR/L 06, S20R PTUNR/L 16
ALV-02-M6X17	M6x1.0	17	10	5.85	2.5	P-SİSTEM için / For P-SYSTEM / FÜR P-SYSTEM CNMG 09, DNMG 11, SNMG 09, TNMG 16, WNMG 06
ALV-03-M8X19	M8X1.0	19.8	11	7.9	3	P-SİSTEM için / For P-SYSTEM / FÜR P-SYSTEM CNMG 12, SNMG 12, TNMG 22, WNMG 08, DNMG 15
ALV-04-M8X22	M8X1.0	21.5	13	7.75	3	P-SİSTEM için / For P-SYSTEM / FÜR P-SYSTEM CNMG 16, SNMG 15
ALV-05-M10X27	M10X1.0	27.5	15	9.9	4	P-SİSTEM için / For P-SYSTEM / FÜR P-SYSTEM CNMG 19, SNMG 19
ALV-06-M12X36	M12X1.0	36	20	12	5	P-SİSTEM için / For P-SYSTEM / FÜR P-SYSTEM CNMG 25, SNMG 25
ALV-07-M6X13	M6X1.0	12.6	6.5	5.9	2.5	P-SİSTEM için / For P-SYSTEM / FÜR P-SYSTEM S16P PCLNR/L 09, S16P PTUNR/L 16
ALV-08-M8X16	M8X1.0	16	10	7.9	3	P-SİSTEM için / For P-SYSTEM / FÜR P-SYSTEM S25S PCLNR/L 12, S25S PDUNR/L 15, S25S PSKNR/L 12
ALV-10-M5X10	M5x0.8	10	4.6	4.9	2.5	P-SİSTEM için / For P-SYSTEM / FÜR P-SYSTEM TNMG 11

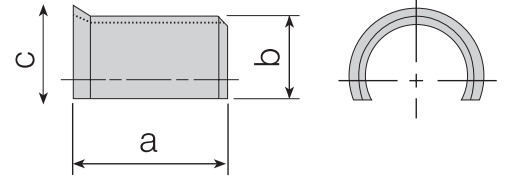

ALTLIK YAYLARI / SHIM SPRINGS / BEFESTIGUNGSFEDER

Takım Kodu Ordering Code Bestell-Bezeichnung	ALTLIK YAYLARI / SHIM SPRINGS / BEFESTIGUNGSFEDER				
	a	b	c	Ürün Detayı / Product Detail / Produkt-Details	
AA-Y-01	5.6	4.9	6	P-SİSTEM için / For P-SYSTEM / FÜR P-SYSTEM CNMG 09 ,DNMG 11, SNMG 09, TNMG 16, WNMG 06	
AA-Y-02	6	6.9	7.9	P-SİSTEM için / For P-SYSTEM / FÜR P-SYSTEM CNMG 12, SNMG 12, TNMG 22, WNMG 08, DNMG 15	
AA-Y-03	8.9	8	9.5	P-SİSTEM için / For P-SYSTEM / FÜR P-SYSTEM CNMG 16, SNMG 15	
AA-Y-04	11	9.8	10.7	P-SİSTEM için / For P-SYSTEM / FÜR P-SYSTEM CNMG 19, SNMG 19	
AA-Y-05	12	13	15	P-SİSTEM için / For P-SYSTEM / FÜR P-SYSTEM CNMG 25, SNMG 25	
AA-Y-07	5.6	4.9	6	P-SİSTEM için / For P-SYSTEM / FÜR P-SYSTEM CNMG 09, TNMG 16	

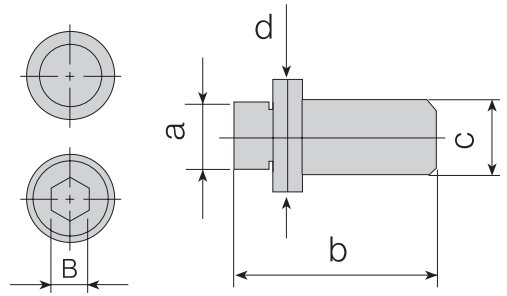

PİMLER / PINS / STIFT

Takım Kodu Ordering Code Bestell-Bezeichnung	PİMLER / PINS / STIFT					
	a	b	c	d	B	Ürün Detayı / Product Detail / Produkt-Details
APM-01	3.55	18	5	6	-	M-SİSTEM için / For M-SYSTEM / FÜR M-SYSTEMMM Delik İçi / Internal / Intern Ø32-Ø40 TNMG 16 Dış Çap / External / Externe TNMG 16
APM-02	5	18	6	7.3	-	M-SİSTEM için / For M-SYSTEM / FÜR M-SYSTEMMM TNMG 22, WNMG 08
APM-03	3.5	12	5	6.5	-	M-SİSTEM için / For M-SYSTEM / FÜR M-SYSTEMMM S20R MTFNR/L 16, S20R MT-NR/L 16, S20R MTUNR/L 16, S20R MTQNR/L 16, S20R MDUNR/L 11
APM-04	5	15	6	7.3	-	M-SİSTEM için / For M-SYSTEM / FÜR M-SYSTEMMM S32T MCLNR/L 12, DNMG 15, S25S MWLNR/L 08
APM-05	4.50	11.5	6.5	6.5	3	M-SİSTEM için / For M-SYSTEM / FÜR M-SYSTEMMM MSYNR 11.5CS 12 Kartuş için / for Cartridge / FÜR KASSETTE
APM-06	3	15.7	-	-	-	C-SİSTEM için / For C-SYSTEM / FÜR C-SYSTEM 154.91
APM-07	3.5	11.5	6.5	6.5	3	M-SİSTEM için / For M-SYSTEM / FÜR M-SYSTEMMM S20R ET-NR 16
APM-08	3.5	12	5	5.4	-	M-SİSTEM için / For M-SYSTEM / FÜR M-SYSTEMMM S25S MWLNR/L 06, Dış Çap / External / Externe
APM-09	3.5	10	5	5.4	-	M-SİSTEM için / For M-SYSTEM / FÜR M-SYSTEMMM S16P MWLNR/L 06
APM-10	3.5	11	5	5.4	-	M-SİSTEM için / For M-SYSTEM / FÜR M-SYSTEMMM S20R MWLNR/L 06
APM-11	3.5	11	5	6.5	-	M-SİSTEM için / For M-SYSTEM / FÜR M-SYSTEMMM S20R MTQNR/L 16
APM-12	5	12	6	7.3	-	M-SİSTEM için / For M-SYSTEM / FÜR M-SYSTEMMM S20R MCLNR/L 12, S25S MCLNR/L 12-Z
APM-13	5	14	6	7.3	-	M-SİSTEM için / For M-SYSTEM / FÜR M-SYSTEMMM S25S MCLNR/L 12
APM-14	3.55	15	5	6	-	M-SİSTEM için / For M-SYSTEM / FÜR M-SYSTEMMM S25S MTFNR/L 16, S25S MT-NR/L 16, S25S MTUNR/L 16, S25S MTQNR/L 16
APM-15	4.40	16	6.40	6.40	3	M-SİSTEM için / For M-SYSTEM / FÜR M-SYSTEMMM MSYNR 16CS 12 Kartuş için / for Cartridge / FÜR KASSETTE

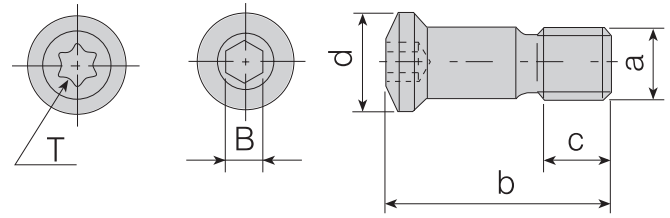

KÜRESEL FİNİŞ VİDALARI / BALL NOSE SCREWS / SCHRAUBE FÜR KUGELKOPFFRÄSER

Takım Kodu Ordering Code Bestell-Bezeichnung	a (M)	b	c	d	B(T)	Ürün Detayı / Product Detail / Produkt-Details	
1208-M3x7	M3x0.5	6.9	2.7	4.1	8	KÜRESEL FREZE VİDASI / BALL NOSE SCREW / SCHRAUBE FÜR KUGELFRÄSER	P3208
1215-M4X0.5X9	M4X0.5	8.6	3.2	5.75	15	KÜRESEL FREZE VİDASI / BALL NOSE SCREW / SCHRAUBE FÜR KUGELFRÄSER	P3210-ROHX 12
1220-M5X0.5X9	M5X0.5	9.6	3.4	6.8	20	KÜRESEL FREZE VİDASI / BALL NOSE SCREW / SCHRAUBE FÜR KUGELFRÄSER	P3212
1220-M5X0.5X12	M5X0.5	12.9	4.4	7.4	20	KÜRESEL FREZE VİDASI / BALL NOSE SCREW / SCHRAUBE FÜR KUGELFRÄSER	P3216-ROHX 16
1220-M5X0.5X15	M5X0.5	16.4	6	7.8	20	KÜRESEL FREZE VİDASI / BALL NOSE SCREW / SCHRAUBE FÜR KUGELFRÄSER	P3220-ROHX 20
1220-M6X0.75X20	M6X0.75	20	6	9.4	20	KÜRESEL FREZE VİDASI / BALL NOSE SCREW / SCHRAUBE FÜR KUGELFRÄSER	P3225
1204-M8X0.75X26	M8X0.75	26	7.5	12	4	KÜRESEL FREZE VİDASI / BALL NOSE SCREW / SCHRAUBE FÜR KUGELFRÄSER	P3232
1210-M3.5X9.6	M3.5X0.6	9.6	4	4.7	10	KÜRESEL FREZE VİDASI / BALL NOSE SCREW / SCHRAUBE FÜR KUGELFRÄSER	BNM 12
1215-M4X13.5	M4X0.7	13.5	5	5.8	15	KÜRESEL FREZE VİDASI / BALL NOSE SCREW / SCHRAUBE FÜR KUGELFRÄSER	BNM 16

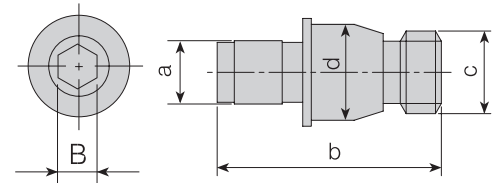
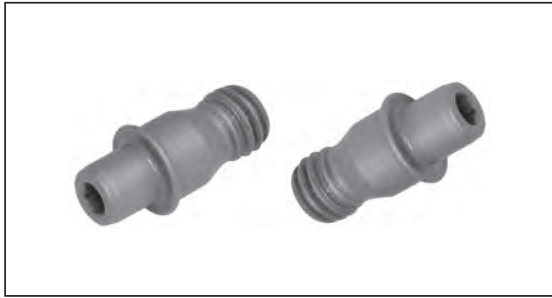

EKSANTRİK VİDA / ECCENTRIC SCREW / EXZENTERSCHRAUBEN

Takım Kodu Ordering Code Bestell-Bezeichnung	a	b	c	d	B	Ürün Detayı / Product Detail / Produkt-Details	
AEV-01-M6x16	4.85	16	M6x1.0	6.5	2.5	Eksantrik Vıda / Eccentric Screw / EXZENTERSCHRAUBEN	PSDNN Kartuş için / for Cartridge / FÜR KASSETTE

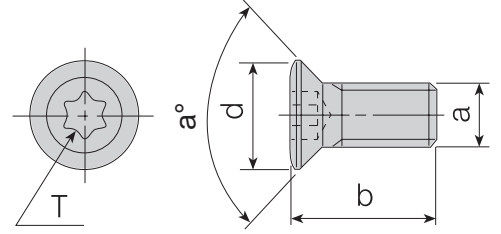

TORK VİDALARI / TORX SCREWS / TORX-SCHRAUBEN

Takım Kodu Ordering Code Bestell-Bezeichnung	a (M)	b	T	d	a°	Ürün Detayı / Product Detail / Produkt-Details	
4006-M1.6x3.2	M1.6X0.35	3.2	6	2.5	60	S-SİSTEM için / For S-SYSTEM / FÜR S-SYSTEM	TORK VİDA / TORX SCREW / TORX-SCHRAUBEN
3006-M1.8x4	M1.8X0.35	4	6	2.45	60	S-SİSTEM için / For S-SYSTEM / FÜR S-SYSTEM	TORK VİDA / TORX SCREW / TORX-SCHRAUBEN
3006-M2x3.1	M2X0.4	3.1	6	2.7	60	S-SİSTEM için / For S-SYSTEM / FÜR S-SYSTEM	TORK VİDA / TORX SCREW / TORX-SCHRAUBEN
3006-M2x3.3	M2X0.4	3.3	6	2.7	60	S-SİSTEM için / For S-SYSTEM / FÜR S-SYSTEM	TORK VİDA / TORX SCREW / TORX-SCHRAUBEN
3006-M2X3.6	M2X0.4	3.6	6	2.7	60	S-SİSTEM için / For S-SYSTEM / FÜR S-SYSTEM	TORK VİDA / TORX SCREW / TORX-SCHRAUBEN
3006-M2x4	M2X0.4	4.3	6	2.7	60	S-SİSTEM için / For S-SYSTEM / FÜR S-SYSTEM	TORK VİDA / TORX SCREW / TORX-SCHRAUBEN
4006-M2x5	M2X0.4	5	6	3	55	S-SİSTEM için / For S-SYSTEM / FÜR S-SYSTEM	TORK VİDA / TORX SCREW / TORX-SCHRAUBEN
3007-M2.2x4.6	M2.2X0.45	4.6	7	3.15	60	S-SİSTEM için / For S-SYSTEM / FÜR S-SYSTEM	TORK VİDA / TORX SCREW / TORX-SCHRAUBEN
4006-M2.2x5	M2.2X0.45	5	6	2.8	55	S-SİSTEM için / For S-SYSTEM / FÜR S-SYSTEM	TORK VİDA / TORX SCREW / TORX-SCHRAUBEN
1008-M2.5x5	M2.5X0.45	5.5	8	3.5	45	S-SİSTEM için / For S-SYSTEM / FÜR S-SYSTEM	TORK VİDA / TORX SCREW / TORX-SCHRAUBEN
1008-M2.5x7	M2.5X0.45	7	8	3.6	45	S-SİSTEM için / For S-SYSTEM / FÜR S-SYSTEM	TORK VİDA / TORX SCREW / TORX-SCHRAUBEN
1108-M2.5x6	M2.5X0.45	6	8	3.9	R	S-SİSTEM için / For S-SYSTEM / FÜR S-SYSTEM	TORK VİDA / TORX SCREW / TORX-SCHRAUBEN
3008-M2.5x5	M2.5X0.45	5	8	3.5	60	S-SİSTEM için / For S-SYSTEM / FÜR S-SYSTEM	TORK VİDA / TORX SCREW / TORX-SCHRAUBEN
3008-M2.5x6	M2.5X0.45	6	8	3.5	60	S-SİSTEM için / For S-SYSTEM / FÜR S-SYSTEM	TORK VİDA / TORX SCREW / TORX-SCHRAUBEN
3008-M2.5X8	M2.5X0.45	8	8	3.5	50	S-SİSTEM için / For S-SYSTEM / FÜR S-SYSTEM	TORK VİDA / TORX SCREW / TORX-SCHRAUBEN
4008-M2.5x4	M2.5X0.45	4	8	3.5	45	S-SİSTEM için / For S-SYSTEM / FÜR S-SYSTEM	TORK VİDA / TORX SCREW / TORX-SCHRAUBEN
4008-M2.5x4.5	M2.5X0.45	4.5	8	3.5	45	S-SİSTEM için / For S-SYSTEM / FÜR S-SYSTEM	TORK VİDA / TORX SCREW / TORX-SCHRAUBEN
4008-M2.5x6	M2.5X0.45	5.8	8	3.5	45	S-SİSTEM için / For S-SYSTEM / FÜR S-SYSTEM	TORK VİDA / TORX SCREW / TORX-SCHRAUBEN
4008-M2.5x6.5	M2.5X0.45	6.5	8	4	60	S-SİSTEM için / For S-SYSTEM / FÜR S-SYSTEM	TORK VİDA / TORX SCREW / TORX-SCHRAUBEN
4108-M2.5x6.5	M2.5X0.45	6.5	8	3.5	50	S-SİSTEM için / For S-SYSTEM / FÜR S-SYSTEM	TORK VİDA / TORX SCREW / TORX-SCHRAUBEN
4108-M2.5x8	M2.5X0.45	8	8	3.5	50	S-SİSTEM için / For S-SYSTEM / FÜR S-SYSTEM	TORK VİDA / TORX SCREW / TORX-SCHRAUBEN
1008-M3x6	M3X0.5	6	8	4	60	S-SİSTEM için / For S-SYSTEM / FÜR S-SYSTEM	TORK VİDA / TORX SCREW / TORX-SCHRAUBEN
1008-M3x8	M3X0.5	8	8	3.9	60	S-SİSTEM için / For S-SYSTEM / FÜR S-SYSTEM	TORK VİDA / TORX SCREW / TORX-SCHRAUBEN
1108-M3x6.8	M3X0.5	6.8	8	4	60	S-SİSTEM için / For S-SYSTEM / FÜR S-SYSTEM	TORK VİDA / TORX SCREW / TORX-SCHRAUBEN
3008-M3x6	M3X0.5	6	8	4	45	S-SİSTEM için / For S-SYSTEM / FÜR S-SYSTEM	TORK VİDA / TORX SCREW / TORX-SCHRAUBEN
3008-M3x7	M3X0.5	7	8	4	55	S-SİSTEM için / For S-SYSTEM / FÜR S-SYSTEM	TORK VİDA / TORX SCREW / TORX-SCHRAUBEN
3008-M3x8	M3X0.5	8	8	4	45	S-SİSTEM için / For S-SYSTEM / FÜR S-SYSTEM	TORK VİDA / TORX SCREW / TORX-SCHRAUBEN
3108-M3x6	M3X0.5	6	8	3.8	60	S-SİSTEM için / For S-SYSTEM / FÜR S-SYSTEM	TORK VİDA / TORX SCREW / TORX-SCHRAUBEN
4008-M3x8	M3X0.5	8	8	4	60	S-SİSTEM için / For S-SYSTEM / FÜR S-SYSTEM	TORK VİDA / TORX SCREW / TORX-SCHRAUBEN
4010-M3x6	M3X0.5	6	10	4.2	45	S-SİSTEM için / For S-SYSTEM / FÜR S-SYSTEM	TORK VİDA / TORX SCREW / TORX-SCHRAUBEN
4010-M3x8	M3X0.5	8	10	4.2	45	S-SİSTEM için / For S-SYSTEM / FÜR S-SYSTEM	TORK VİDA / TORX SCREW / TORX-SCHRAUBEN
1015-M3.5x9	M3.5X0.6	9	15	5.3	60	S-SİSTEM için / For S-SYSTEM / FÜR S-SYSTEM	TORK VİDA / TORX SCREW / TORX-SCHRAUBEN
1015-M3.5x11	M3.5X0.6	11.1	15	5.3	60	S-SİSTEM için / For S-SYSTEM / FÜR S-SYSTEM	TORK VİDA / TORX SCREW / TORX-SCHRAUBEN
1015-M3.5x14	M3.5X0.6	14	15	5.3	66	S-SİSTEM için / For S-SYSTEM / FÜR S-SYSTEM	TORK VİDA / TORX SCREW / TORX-SCHRAUBEN
1015-M3.5x16	M3.5X0.6	16	15	5.3	55	S-SİSTEM için / For S-SYSTEM / FÜR S-SYSTEM	TORK VİDA / TORX SCREW / TORX-SCHRAUBEN
1315-M3.5x11	M3.5X0.6	10.6	15	7.9	-	S-SİSTEM için / For S-SYSTEM / FÜR S-SYSTEM	TORK VİDA / TORX SCREW / TORX-SCHRAUBEN
1510-M3.5x7	M3.5X0.6	7.1	10	5.1	55	S-SİSTEM için / For S-SYSTEM / FÜR S-SYSTEM	TORK VİDA / TORX SCREW / TORX-SCHRAUBEN
1510-M3.5x9	M3.5X0.6	9.1	10	5	55	S-SİSTEM için / For S-SYSTEM / FÜR S-SYSTEM	TORK VİDA / TORX SCREW / TORX-SCHRAUBEN
1615-M3.5x10	M3.5X0.6	10	15	5.8	60	S-SİSTEM için / For S-SYSTEM / FÜR S-SYSTEM	TORK VİDA / TORX SCREW / TORX-SCHRAUBEN
1615-M3.5x11	M3.5X0.6	11	15	5.8	60	S-SİSTEM için / For S-SYSTEM / FÜR S-SYSTEM	TORK VİDA / TORX SCREW / TORX-SCHRAUBEN
1615-M3.5x15	M3.5X0.6	15	15	5.8	60	S-SİSTEM için / For S-SYSTEM / FÜR S-SYSTEM	TORK VİDA / TORX SCREW / TORX-SCHRAUBEN
3010-M3.5x7	M3.5X0.6	7	10	5	55	S-SİSTEM için / For S-SYSTEM / FÜR S-SYSTEM	TORK VİDA / TORX SCREW / TORX-SCHRAUBEN
3010-M3.5x9	M3.5X0.6	9	10	5	55	S-SİSTEM için / For S-SYSTEM / FÜR S-SYSTEM	TORK VİDA / TORX SCREW / TORX-SCHRAUBEN
3015-M3.5x9	M3.5X0.6	8.8	15	5.4	60	S-SİSTEM için / For S-SYSTEM / FÜR S-SYSTEM	TORK VİDA / TORX SCREW / TORX-SCHRAUBEN
4015-M3.5x8	M3.5X0.6	7.9	15	5.3	55	S-SİSTEM için / For S-SYSTEM / FÜR S-SYSTEM	TORK VİDA / TORX SCREW / TORX-SCHRAUBEN
4015-M3.5x9	M3.5X0.6	8.7	15	5.3	60	S-SİSTEM için / For S-SYSTEM / FÜR S-SYSTEM	TORK VİDA / TORX SCREW / TORX-SCHRAUBEN
4015-M3.5x10	M3.5X0.6	9.8	15	5.3	60	S-SİSTEM için / For S-SYSTEM / FÜR S-SYSTEM	TORK VİDA / TORX SCREW / TORX-SCHRAUBEN

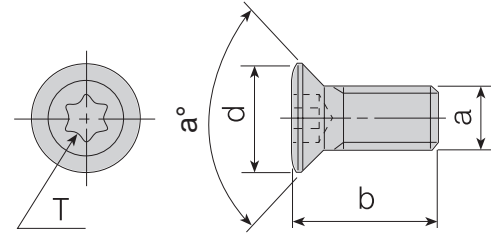

TORK VİDALARI / TORX SCREWS / TORX-SCHRAUBEN

Takım Kodu Ordering Code Bestell-Bezeichnung	a (M)	b	T	d	a°	Ürün Detayı / Product Detail / Produkt-Details	
4015-M3.5x11	M3.5X0.6	10.7	15	5.3	60	S-SİSTEM için / For S-SYSTEM / FÜR S-SYSTEM	TORK VİDA / TORX SCREW / TORX-SCHRAUBEN
4015-M3.5x12	M3.5X0.6	12	15	5.3	60	S-SİSTEM için / For S-SYSTEM / FÜR S-SYSTEM	TORK VİDA / TORX SCREW / TORX-SCHRAUBEN
4015-M3.5x14	M3.5X0.6	13.7	15	5.3	60	S-SİSTEM için / For S-SYSTEM / FÜR S-SYSTEM	TORK VİDA / TORX SCREW / TORX-SCHRAUBEN
1015-M4x8	M4X0.7	8	15	6.8	R	S-SİSTEM için / For S-SYSTEM / FÜR S-SYSTEM	TORK VİDA / TORX SCREW / TORX-SCHRAUBEN
1015-M4x9	M4X0.7	9	15	6.8	R	S-SİSTEM için / For S-SYSTEM / FÜR S-SYSTEM	TORK VİDA / TORX SCREW / TORX-SCHRAUBEN
1515-M4x9	M4X0.7	9	15	5.7	50	S-SİSTEM için / For S-SYSTEM / FÜR S-SYSTEM	TORK VİDA / TORX SCREW / TORX-SCHRAUBEN
1015-M4x11	M4X0.7	10.8	15	6.8	R	S-SİSTEM için / For S-SYSTEM / FÜR S-SYSTEM	TORK VİDA / TORX SCREW / TORX-SCHRAUBEN
1115-M4x10	M4X0.7	10	15	5.9	R	S-SİSTEM için / For S-SYSTEM / FÜR S-SYSTEM	TORK VİDA / TORX SCREW / TORX-SCHRAUBEN
1315-M4x11	M4X0.7	11.1	15	5	45	S-SİSTEM için / For S-SYSTEM / FÜR S-SYSTEM	TORK VİDA / TORX SCREW / TORX-SCHRAUBEN
1415-M4x11	M4X0.7	11	15	5.6	50	S-SİSTEM için / For S-SYSTEM / FÜR S-SYSTEM	TORK VİDA / TORX SCREW / TORX-SCHRAUBEN
1515-M4x11	M4X0.7	11.1	15	5.6	50	S-SİSTEM için / For S-SYSTEM / FÜR S-SYSTEM	TORK VİDA / TORX SCREW / TORX-SCHRAUBEN
1615-M4x11	M4X0.7	11.1	15	6	50	S-SİSTEM için / For S-SYSTEM / FÜR S-SYSTEM	TORK VİDA / TORX SCREW / TORX-SCHRAUBEN
3015-M4x9	M4X0.7	9	15	5.6	50	S-SİSTEM için / For S-SYSTEM / FÜR S-SYSTEM	TORK VİDA / TORX SCREW / TORX-SCHRAUBEN
3015-M4x11	M4X0.7	11	15	5.6	50	S-SİSTEM için / For S-SYSTEM / FÜR S-SYSTEM	TORK VİDA / TORX SCREW / TORX-SCHRAUBEN
4015-M4X8	M4X0.7	8	15	5.6	50	S-SİSTEM için / For S-SYSTEM / FÜR S-SYSTEM	TORK VİDA / TORX SCREW / TORX-SCHRAUBEN
4015-M4x9	M4X0.7	9	15	5.6	50	S-SİSTEM için / For S-SYSTEM / FÜR S-SYSTEM	TORK VİDA / TORX SCREW / TORX-SCHRAUBEN
4015-M4x10	M4X0.7	10	15	5.6	50	S-SİSTEM için / For S-SYSTEM / FÜR S-SYSTEM	TORK VİDA / TORX SCREW / TORX-SCHRAUBEN
4015-M4x11	M4X0.7	11	15	5.6	50	S-SİSTEM için / For S-SYSTEM / FÜR S-SYSTEM	TORK VİDA / TORX SCREW / TORX-SCHRAUBEN
4015-M4x12	M4X0.7	12	15	5.7	50	S-SİSTEM için / For S-SYSTEM / FÜR S-SYSTEM	TORK VİDA / TORX SCREW / TORX-SCHRAUBEN
4115-M4x12	M4X0.7	12	15	5.6	55	S-SİSTEM için / For S-SYSTEM / FÜR S-SYSTEM	TORK VİDA / TORX SCREW / TORX-SCHRAUBEN
4515-M4x8	M4X0.7	8	15	5.1	50	S-SİSTEM için / For S-SYSTEM / FÜR S-SYSTEM	TORK VİDA / TORX SCREW / TORX-SCHRAUBEN
4515-M4x11	M4X0.7	11	15	5.1	50	S-SİSTEM için / For S-SYSTEM / FÜR S-SYSTEM	TORK VİDA / TORX SCREW / TORX-SCHRAUBEN
4615-M4x11	M4X0.7	11	15	6	50	S-SİSTEM için / For S-SYSTEM / FÜR S-SYSTEM	TORK VİDA / TORX SCREW / TORX-SCHRAUBEN
1015-M4.5x12	M4.5X0.75	12	15	6.6	50	S-SİSTEM için / For S-SYSTEM / FÜR S-SYSTEM	TORK VİDA / TORX SCREW / TORX-SCHRAUBEN
1020-M4.5x14	M4.5X0.75	14	20	6.5	45	S-SİSTEM için / For S-SYSTEM / FÜR S-SYSTEM	TORK VİDA / TORX SCREW / TORX-SCHRAUBEN
1020-M4.5x16	M4.5X0.75	16	20	6.5	45	S-SİSTEM için / For S-SYSTEM / FÜR S-SYSTEM	TORK VİDA / TORX SCREW / TORX-SCHRAUBEN
1120-M4.5x12	M4.5X0.75	12.1	20	7.9	R	S-SİSTEM için / For S-SYSTEM / FÜR S-SYSTEM	TORK VİDA / TORX SCREW / TORX-SCHRAUBEN
1515-M4.5x11	M4.5X0.75	11	15	6.4	45	S-SİSTEM için / For S-SYSTEM / FÜR S-SYSTEM	TORK VİDA / TORX SCREW / TORX-SCHRAUBEN
4015-M4.5x11	M4.5X0.75	11	15	6.4	45	S-SİSTEM için / For S-SYSTEM / FÜR S-SYSTEM	TORK VİDA / TORX SCREW / TORX-SCHRAUBEN
4020-M4.5x10	M4.5X0.75	10	20	6.5	55	S-SİSTEM için / For S-SYSTEM / FÜR S-SYSTEM	TORK VİDA / TORX SCREW / TORX-SCHRAUBEN
4020-M4.5x12	M4.5X0.75	12	20	6.5	55	S-SİSTEM için / For S-SYSTEM / FÜR S-SYSTEM	TORK VİDA / TORX SCREW / TORX-SCHRAUBEN
1020-M5x7.5	M5X0.8	7.5	20	6.5	50	S-SİSTEM için / For S-SYSTEM / FÜR S-SYSTEM	TORK VİDA / TORX SCREW / TORX-SCHRAUBEN
1020-M5x11	M5X0.8	11	20	6.6	50	S-SİSTEM için / For S-SYSTEM / FÜR S-SYSTEM	TORK VİDA / TORX SCREW / TORX-SCHRAUBEN
1020-M5x14	M5X0.8	14.1	20	6.8	50	S-SİSTEM için / For S-SYSTEM / FÜR S-SYSTEM	TORK VİDA / TORX SCREW / TORX-SCHRAUBEN
1120-M5x13	M5X0.8	13	20	7	R	S-SİSTEM için / For S-SYSTEM / FÜR S-SYSTEM	TORK VİDA / TORX SCREW / TORX-SCHRAUBEN
1615-M5x14	M5X0.8	14	15	7.3	50	S-SİSTEM için / For S-SYSTEM / FÜR S-SYSTEM	TORK VİDA / TORX SCREW / TORX-SCHRAUBEN
1620-M5x18	M5X0.8	18	20	8.15	50	S-SİSTEM için / For S-SYSTEM / FÜR S-SYSTEM	TORK VİDA / TORX SCREW / TORX-SCHRAUBEN
1620-M5x22	M5X0.8	22	20	8.15	50	S-SİSTEM için / For S-SYSTEM / FÜR S-SYSTEM	TORK VİDA / TORX SCREW / TORX-SCHRAUBEN
4420-M5x14	M5X0.8	14	20	6.6	60	S-SİSTEM için / For S-SYSTEM / FÜR S-SYSTEM	TORK VİDA / TORX SCREW / TORX-SCHRAUBEN
1020-M6x16	M6X1.0	16	20	8.5	50	S-SİSTEM için / For S-SYSTEM / FÜR S-SYSTEM	TORK VİDA / TORX SCREW / TORX-SCHRAUBEN
1420-M6x16	M6X1.0	16	20	7.6	50	S-SİSTEM için / For S-SYSTEM / FÜR S-SYSTEM	TORK VİDA / TORX SCREW / TORX-SCHRAUBEN
1520-M6x16	M6X1.0	16	20	8.2	50	S-SİSTEM için / For S-SYSTEM / FÜR S-SYSTEM	TORK VİDA / TORX SCREW / TORX-SCHRAUBEN
1710-U5-40x12.2	UNC 5-40	12.2	10	5.6	60	S-SİSTEM için / For S-SYSTEM / FÜR S-SYSTEM	TORK VİDA / TORX SCREW / TORX-SCHRAUBEN
1720-U8-32x10	UNC 8-32	10	20	7.5	60	S-SİSTEM için / For S-SYSTEM / FÜR S-SYSTEM	TORK VİDA / TORX SCREW / TORX-SCHRAUBEN
1720-U8-32x15	UNC 8-32	15	20	7.5	60	S-SİSTEM için / For S-SYSTEM / FÜR S-SYSTEM	TORK VİDA / TORX SCREW / TORX-SCHRAUBEN
1707-U4-48x6	UNF 4-48	6	7	3.27	60	S-SİSTEM için / For S-SYSTEM / FÜR S-SYSTEM	TORK VİDA / TORX SCREW / TORX-SCHRAUBEN
1707-U4-48x6.5	UNF 4-48	6.5	7	3.27	60	S-SİSTEM için / For S-SYSTEM / FÜR S-SYSTEM	TORK VİDA / TORX SCREW / TORX-SCHRAUBEN
1707-U4-48x8.2	UNF 4-48	8.2	7	3.27	60	S-SİSTEM için / For S-SYSTEM / FÜR S-SYSTEM	TORK VİDA / TORX SCREW / TORX-SCHRAUBEN

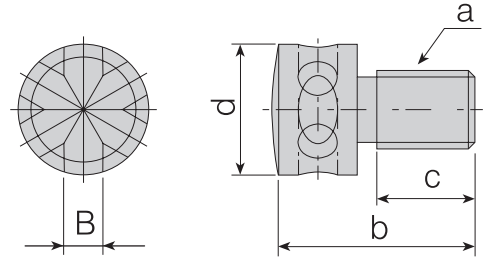

EKSENEL AYAR VİDALARI / AXIAL ADJUSTING SCREWS / AXIAL-EINSTELLSCHRAUBE

Takım Kodu Ordering Code Bestell-Bezeichnung	a (M)	b	c	d	B	Ürün Detayı / Product Detail / Produkt-Details	
						Ürün Detayı / Product Detail / Produkt-Details	Ürün Detayı / Product Detail / Produkt-Details
2600-M4x9.5	M4x0.5	9.5	4	4	1.5	Kartuş için / for Cartridge / FÜR KASSETTE	Eksenel Ayar Vida / Axial Adjust Screw / Axial-Einstellschraube
2600-M5x13	M5x0.5	13	7	8	2.5	Kartuş için / for Cartridge / FÜR KASSETTE	Eksenel Ayar Vida / Axial Adjust Screw / Axial-Einstellschraube
2600-M6x18	M6x1.0	18	9	10	3.5	Kartuş için / for Cartridge / FÜR KASSETTE	Eksenel Ayar Vida / Axial Adjust Screw / Axial-Einstellschraube

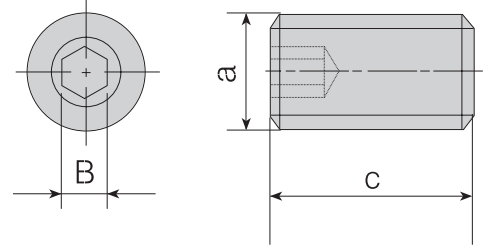
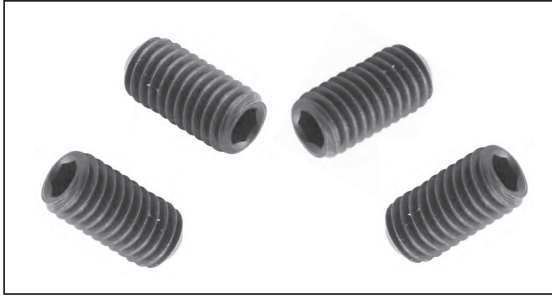

RADYAL AYAR VİDALARI / RADIAL ADJUSTING SCREWS / AXIAL-EINSTELLSCHRAUBE

Takım Kodu Ordering Code Bestell-Bezeichnung	a (M)	c	B	Ürün Detayı / Product Detail / Produkt-Details	
				Ürün Detayı / Product Detail / Produkt-Details	Ürün Detayı / Product Detail / Produkt-Details
2715-M3x4	M3x0.5	4	1.5	KABA BARA için / for ROUGH BORING HEADS FÜR SCHRUPP-SPINDELKOPF	KABA BARA KARTUŞU için / for ROUGH BORING HEADS CARTRIDGE FÜR KASSETTEN DER SCHRUPP-SPINDELKÖPFE
2715-M3x5	M3x0.5	5	1.5	KABA BARA için / for ROUGH BORING HEADS FÜR SCHRUPP-SPINDELKOPF	KABA BARA KARTUŞU için / for ROUGH BORING HEADS CARTRIDGE FÜR KASSETTEN DER SCHRUPP-SPINDELKÖPFE
2715-M3x8	M3x0.5	8	1.5	KABA BARA için / for ROUGH BORING HEADS FÜR SCHRUPP-SPINDELKOPF	KABA BARA KARTUŞU için / for ROUGH BORING HEADS CARTRIDGE FÜR KASSETTEN DER SCHRUPP-SPINDELKÖPFE
2702-M4x4	M4x0.7	4	2	KARTUŞ için / for CARTRIDGE / FÜR KASSETTE	KARTUŞ için / for CARTRIDGE / FÜR KASSETTE
2702-M4x10	M4x0.7	10	2	KARTUŞ için / for CARTRIDGE / FÜR KASSETTE	KARTUŞ için / for CARTRIDGE / FÜR KASSETTE
2702-M4x12	M4x0.7	12	2	KABA BARA için / for ROUGH BORING HEADS FÜR SCHRUPP-SPINDELKOPF	KABA BARA KARTUŞU için / for ROUGH BORING HEADS CARTRIDGE FÜR KASSETTEN DER SCHRUPP-SPINDELKÖPFE
2725-M5x6	M5x0.8	5	2.5	KARTUŞ için / for CARTRIDGE / FÜR KASSETTE	KARTUŞ için / for CARTRIDGE / FÜR KASSETTE
2725-M5x10	M5x0.8	10	2.5	KARTUŞ için / for CARTRIDGE / FÜR KASSETTE	KARTUŞ için / for CARTRIDGE / FÜR KASSETTE
2725-M5x12	M5x0.8	12	2.5	KABA BARA için / for ROUGH BORING HEADS FÜR SCHRUPP-SPINDELKOPF	KABA BARA KARTUŞU için / for ROUGH BORING HEADS CARTRIDGE FÜR KASSETTEN DER SCHRUPP-SPINDELKÖPFE
2725-M5x14	M5x0.8	14	2.5	KABA BARA için / for ROUGH BORING HEADS FÜR SCHRUPP-SPINDELKOPF	KABA BARA KARTUŞU için / for ROUGH BORING HEADS CARTRIDGE FÜR KASSETTEN DER SCHRUPP-SPINDELKÖPFE
2703-M6x16	M6x1	16	3	KABA BARA için / for ROUGH BORING HEADS FÜR SCHRUPP-SPINDELKOPF	KABA BARA KARTUŞU için / for ROUGH BORING HEADS CARTRIDGE FÜR KASSETTEN DER SCHRUPP-SPINDELKÖPFE
2704-M8x25	M8x1.25	25.9	4	KABA BARA için / for ROUGH BORING HEADS FÜR SCHRUPP-SPINDELKOPF	KABA BARA KARTUŞU için / for ROUGH BORING HEADS CARTRIDGE FÜR KASSETTEN DER SCHRUPP-SPINDELKÖPFE
2704-M8x1x5	M8x1	5	4	İÇTEN SOĞUTMA KANALLI TAKIMLAR için / for COOLANT TOOLS / IFÜRAUSSEN - DREHHALTER	JET TAKIMLAR için / For JET TOOLS / FÜR JET WERKZEUGE
2705-G1/8x5.5	G1/8	5.5	5	İÇTEN SOĞUTMA KANALLI TAKIMLAR için / for COOLANT TOOLS / IFÜRAUSSEN - DREHHALTER	JET TAKIMLAR için / For JET TOOLS / FÜR JET WERKZEUGE

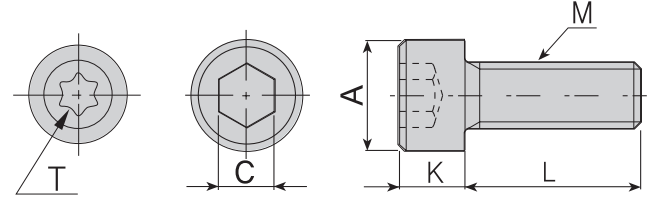

İNBUS CİVATALAR / INBUS SCREWS / INNENSECHSKANT-SCHRAUBE

Takım Kodu Ordering Code Bestell-Bezeichnung	M	A	C	K	L	Ürün Detayı / Product Detail / Produkt-Details	
						Ürün Detayı / Product Detail / Produkt-Details	SCHRAUBE FÜR KASSETTE DER SCHRUPP-SPINDELKÖPFE
2503-M4x10	M4x0.7	6.85	3	4	10	KANAL KATER VİDASI / SOME GROOVING TOOLS SCREW	SCHRAUBEN FÜR STECHHALTER
2525-M3X14	M3X0.5	5.4	2.5	2.9	14	BARA KARTUŞU için SIKMA VİDASI / for BORING HEADS CARTRIDGE SCREW	SCHRAUBE FÜR KASSETTE DER SCHRUPP-SPINDELKÖPFE
2503-M4X20	M4x0.7	7	3	3.9	20	BARA KARTUŞU için SIKMA VİDASI / for BORING HEADS CARTRIDGE SCREW	SCHRAUBE FÜR KASSETTE DER SCHRUPP-SPINDELKÖPFE
2503-M4X12	M4x0.7	6.85	3	4	12	KANAL KATER VİDASI / SOME GROOVING TOOLS SCREW	SCHRAUBEN FÜR STECHHALTER
2503-M4X15	M4x0.7	6.85	3	4	15	BARA KARTUŞU için SIKMA VİDASI / for BORING HEADS CARTRIDGE SCREW	SCHRAUBE FÜR KASSETTE DER SCHRUPP-SPINDELKÖPFE
2504-M5X16	M5X0.8	8.5	4	5	16	KANAL KATER VİDASI / SOME GROOVING TOOLS SCREW	SCHRAUBEN FÜR STECHHALTER
2504-M5X12	M5X0.8	8.5	4	5	12	KANAL KATER VİDASI / SOME GROOVING TOOLS SCREW	SCHRAUBEN FÜR STECHHALTER
2504-M5X25	M5X0.8	8.5	4	5	25	BARA KARTUŞU için SIKMA VİDASI / for BORING HEADS CARTRIDGE SCREW	SCHRAUBE FÜR KASSETTE DER SCHRUPP-SPINDELKÖPFE
2505-M6X16	M6X1	9.9	5	6	16	KANAL KATER VİDASI / SOME GROOVING TOOLS SCREW	SCHRAUBEN FÜR STECHHALTER
2505-M6X20	M6X1	9.9	5	6	20	KANAL KATER VİDASI / SOME GROOVING TOOLS SCREW	SCHRAUBEN FÜR STECHHALTER
2505-M6X25	M6X1	9.9	5	6	25	BLOK BASKI PABUÇ VİDASI / for BLOCK CLAMP SCREW	SCHRAUBE FÜR SPANNBLOCK
2505-M6X30	M6X1	9.9	5	6	30	BARA KARTUŞU için SIKMA VİDASI / for BORING HEADS CARTRIDGE SCREW	SCHRAUBE FÜR KASSETTE DER SCHRUPP-SPINDELKÖPFE
2306-M8X37	M8X1.25	13	6	6.4	31.5	MONTAJ VİDASI (KAFASI KÜÇÜK) / MOUNTING SCREW (SMALL HEAD)	BEFESTIGUNGSSCHRAUBE
2405-M8X30	M8X1.25	13	5	5	30	A16 MONTAJ VİDASI (KAFASI KÜÇÜK) / MOUNTING SCREW (SMALL HEAD)	BEFESTIGUNGSSCHRAUBE (KLEINER KOPF)
2506-M8X20	M8X1.25	13	6	7.9	20	KARTUŞ MONTAJ VİDASI / CARTRIDGE MOUNTING SCREW	BEFESTIGUNGSSCHRAUBE FÜR KASSETTE
2506-M8X30	M8X1.25	13	6	7.9	30	A16 MONTAJ VİDASI / MOUNTING SCREW	BEFESTIGUNGSSCHRAUBE
2506-M8X35	M8X1.25	13	6	7.9	35	BARA KARTUŞU için SIKMA VİDASI / for BORING HEADS CARTRIDGE SCREW	SCHRAUBE FÜR KASSETTE DER SCHRUPP-SPINDELKÖPFE
2406-M8X30	M8X1.25	12	6	7.9	30	A16 MONTAJ VİDASI / MOUNTING SCREW	BEFESTIGUNGSSCHRAUBE
2407-M10X30	M10X1.5	16	7	6	30	A16 MONTAJ VİDASI / MOUNTING SCREW	BEFESTIGUNGSSCHRAUBE
2408-M10X30	M10X1.5	13	8	10	30	A22 MONTAJ VİDASI / MOUNTING SCREW	BEFESTIGUNGSSCHRAUBE
2508-M10X30	M10X1.5	16	8	10	30	A22 MONTAJ VİDASI / MOUNTING SCREW	BEFESTIGUNGSSCHRAUBE
2508-M10X40	M10X1.5	16	8	10	40	BARA KARTUŞU için SIKMA VİDASI / for BORING HEADS CARTRIDGE SCREWS	SCHRAUBE FÜR KASSETTE DER SCHRUPP-SPINDELKÖPFE
2408-M12X35	M12X1.75	18	8	7	35	A27 MONTAJ VİDASI / MOUNTING SCREW	BEFESTIGUNGSSCHRAUBE
2510-M12X35	M12X1.75	18	10	12	35	A27 MONTAJ VİDASI / MOUNTING SCREW	BEFESTIGUNGSSCHRAUBE
2514-M16X35	M16X2.0	23.7	14	16	35	A32 MONTAJ VİDASI / MOUNTING SCREW	BEFESTIGUNGSSCHRAUBE
AAV-11-U5-40x4.5	UNC 5-40	5.4	T10	2.8	4.5	16 ER/L, 16 IR/L ALTLIK VİDASI / SHIM SCREW	SCHRAUBE FÜR UNTERLAGE
AAV-12-U8-32x5.5	UNC 8-32	6.7	T20	3.8	5.5	22 ER/L, 22 IR/L ALTLIK VİDASI / SHIM SCREW	SCHRAUBE FÜR UNTERLAGE
AAV-15-M5x5.7	M5X0.8	8.5	T20	3.15	5.7	27 ER/L, 27 IR/L ALTLIK VİDASI / SHIM SCREW	SCHRAUBE FÜR UNTERLAGE

SEGMAN / RING / RING

Ürün Resmi Product Picture Produkt-Bild	Ürün Kodu Product Code / Code	Ürün Detayı / Product Detail / Produkt-Details	
		ACS-01	C-SİSTEM için / For C-SYSTEM / FÜR C-SYSTEM
AS-01		T-M-SİSTEM için / For T-M-SYSTEM / FÜR T-M-SYSTEM	AKV-30-M6x22 SEGMANI / RING
AS-02		T SİSTEM için / For T SYSTEM / FÜR T-SYSTEM	AKV-19-M7x25 SEGMANI / RING

ORING / ORING / ORING

Ürün Resmi Product Picture Produkt-Bild	ORING / ORING / ORING		
	Ürün Kodu Product Code / Code	Ürün Detayı / Product Detail / Produkt-Details	
	<b>AOR-01</b>	P-SİSTEM için / For P-SYSTEM / FÜR P-SYSTEM	
	<b>AXR-01</b>	T-P SİSTEM için / For T-P SYSTEM / FÜR P-SYSTEM	

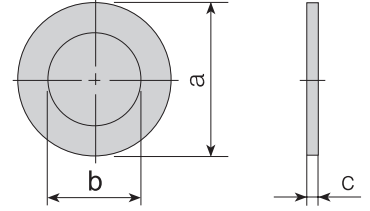

BASKI VE ALTLIK VİDASI PULU / STAMP / UNTERLEGSCHIEBE

Takım Kodu Ordering Code Bestell-Bezeichnung	a	b	c	Ürün Detayı / Product Detail / Produkt-Details	
				<b>ABPL-01</b>	10.5
<b>ABPL-02</b>	12.75	7.1	0.45	PUL/STAMP/RING	BASKI PULU / STAMP / RING
<b>ABPL-03</b>	5.3	3.2	0.5	PUL/STAMP/RING	TER - TIR 16 ER/EL - İR/İL ALTLIK VİDASI PULU / SHIM SCREW RING / SHIM SCREW RING / SCHRAUBE FÜR UNTERLAGENRING
<b>ABPL-04</b>	6.9	4.2	0.5	PUL/STAMP/RING	TER - TIR 22 ER/EL - İR/İL ALTLIK VİDASI PULU / SHIM SCREW RING / SHIM SCREW RING / SCHRAUBE FÜR UNTERLAGENRING
<b>ABPL-05</b>	8.5	5	0.5	PUL/STAMP/RING	TER - TIR 27 ER/EL - İR/İL ALTLIK VİDASI PULU / SHIM SCREW RING / SHIM SCREW RING / SCHRAUBE FÜR UNTERLAGENRING

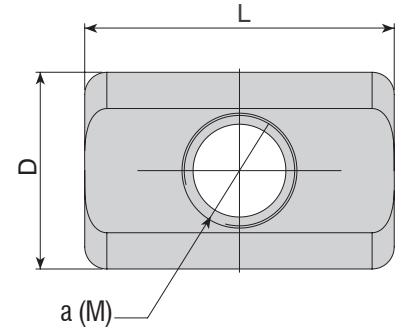



BARA PABUÇLARI / BORING HEADS CARTRIDGE / KASSETTE FÜR SPINDELKOPF

Takım Kodu Ordering Code Bestell-Bezeichnung	a (M)	D	L	Ürün Detayı / Product Detail / Produkt-Details	
				<b>ABKS-D16</b>	M3x0.5
<b>ABKS-D20</b>	M4x0.7	5.9	9	ABA BARA için / for ROUGH BORING HEADS / FÜR SCHRUPP-SPINDELKOPF	ABHR-D20x50-W20-L100
<b>ABKS-D25</b>	M4x0.7	5.9	12	KABA BARA için / for ROUGH BORING HEADS / FÜR SCHRUPP-SPINDELKOPF	ABHR-D25x60-W20-L110
<b>ABKS-D32</b>	M5x0.8	8.9	14	KABA BARA için / for ROUGH BORING HEADS / FÜR SCHRUPP-SPINDELKOPF	ABHR-D32x64-W25-L120
<b>ABKS-D40</b>	M6x1	10.9	18	KABA BARA için / for ROUGH BORING HEADS / FÜR SCHRUPP-SPINDELKOPF	ABHR-D40x80-W32-L140
<b>ABKS-D50</b>	M8x1.25	13.9	28	KABA BARA için / for ROUGH BORING HEADS / FÜR SCHRUPP-SPINDELKOPF	ABHR-D50x100-W32-L160
<b>ABKS-D63</b>	M10x1.5	15.9	35	KABA BARA için / for ROUGH BORING HEADS / FÜR SCHRUPP-SPINDELKOPF	ABHR-D63x80-W32-L140, ABHR-D63x130-W40-L200
<b>ABKS-D80</b>	M12x1.75	17.9	45	KABA BARA için / for ROUGH BORING HEADS / FÜR SCHRUPP-SPINDELKOPF	ABHR-D80x140-W40-L210, ABHR-D80x140-W40-L210-B





Ürün Resmi Product Picture Produkt-Bild	KESME ve KANAL LAMA AÇMA BLOK PABUÇLARI / BLOCKS FOR PARTING AND DEEP GROOVING BLADES CLAMPS KLEMMLEISTE FÜR SCHWERT-SPANNBLOCK		
	Ürün Kodu Product Code / Code	Ürün Detayı / Product Detail / Produkt-Details	
	<b>ABK-01</b>	LAMA BLOĞU için / For BLADE BLOCK / FÜR SCHWERT-SPANNBLOCK	ALBU-20-26 BASKI PABUCU / CLAMP / PRATZE
	<b>ABK-02</b>	LAMA BLOĞU için / For BLADE BLOCK / FÜR SCHWERT-SPANNBLOCK	ALBU-25-26 BASKI PABUCU / CLAMP / PRATZE
	<b>ABK-03</b>	LAMA BLOĞU için / For BLADE BLOCK / FÜR SCHWERT-SPANNBLOCK	ALBU-20-32 BASKI PABUCU / CLAMP / PRATZE
	<b>ABK-04</b>	LAMA BLOĞU için / For BLADE BLOCK / FÜR SCHWERT-SPANNBLOCK	ALBU-25-32, ALBU-32-32 BASKI PABUCU / CLAMP / PRATZE

Ürün Resmi Product Picture Produkt-Bild	LAMA ANAHTARI / BLADE KEY / SCHWERT-SCHLÜSSEL	
	Ürün Kodu Product Code / Code	Ürün Detayı / Product Detail / Produkt-Details
	<b>ALA-01</b>	AKL LAMA ANAHTARI / for BLADE KEY / SCHWERT-SCHLÜSSEL
	<b>ALA-02</b>	AKL LAMA ANAHTARI / for BLADE KEY / SCHWERT-SCHLÜSSEL

Ürün Resmi Product Picture Produkt-Bild	ALYAN ANAHTARLARI / ALLEN KEYS / INNENSECHSKANT-SCHLÜSSEL		
	Ürün Kodu Product Code / Code	Ürün Detayı / Product Detail / Produkt-Details	
	<b>AAL-01-2</b>	2 mm	ALYAN ANAHTARI / ALLEN KEYS / INNENSECHSKANT-SCHLÜSSEL
	<b>AAL-02-2.5</b>	2.5 mm	ALYAN ANAHTARI / ALLEN KEYS / INNENSECHSKANT-SCHLÜSSEL
	<b>AAL-03-3</b>	3 mm	ALYAN ANAHTARI / ALLEN KEYS / INNENSECHSKANT-SCHLÜSSEL
	<b>AAL-05-4</b>	4 mm	ALYAN ANAHTARI / ALLEN KEYS / INNENSECHSKANT-SCHLÜSSEL
	<b>AAL-07-5</b>	5 mm	ALYAN ANAHTARI / ALLEN KEYS / INNENSECHSKANT-SCHLÜSSEL
	<b>AAL-08-6</b>	6 mm	ALYAN ANAHTARI / ALLEN KEYS / INNENSECHSKANT-SCHLÜSSEL
	<b>AAL-09-1.5</b>	1.5 mm	ALYAN ANAHTARI / ALLEN KEYS / INNENSECHSKANT-SCHLÜSSEL
	<b>AAL-11-8</b>	8 mm	ALYAN ANAHTARI / ALLEN KEYS / INNENSECHSKANT-SCHLÜSSEL
	<b>AAL-12-10</b>	10 mm	ALYAN ANAHTARI / ALLEN KEYS / INNENSECHSKANT-SCHLÜSSEL

Ürün Resmi Product Picture Produkt-Bild	TORK ANAHTARLARI / TORX KEYS / TORX-SCHLÜSSEL	
	Ürün Kodu Product Code / Code	Ürün Detayı / Product Detail / Produkt-Details
	<b>82-T06</b>	T06 TORK ANAHTARI / TORX KEY / TORX-SCHLÜSSEL
	<b>82-T07</b>	T07 TORK ANAHTARI / TORX KEY / TORX-SCHLÜSSEL
	<b>82-T08</b>	T08 TORK ANAHTARI / TORX KEY / TORX-SCHLÜSSEL
	<b>82-T10</b>	T10 TORK ANAHTARI / TORX KEY / TORX-SCHLÜSSEL
	<b>80-T15</b>	T15 TORK ANAHTARI / TORX KEY / TORX-SCHLÜSSEL
	<b>80-T20</b>	T20 TORK ANAHTARI / TORX KEY / TORX-SCHLÜSSEL
	<b>81-T15</b>	T15 T-TİP TORK ANAHTARI / T-TYPE TORX KEY / T-TYP-TORX-SCHLÜSSEL
	<b>81-T20</b>	T20 T-TİP TORK ANAHTARI / T-TYPE TORX KEY / T-TYP-TORX-SCHLÜSSEL

KOD / CODE	AÇIKLAMA / DESCRIPTION	BESCHREIBUNG	SN. / PN. SEITE
A/PTFNR/L ..	Boring Bars	Bohstangen	92
A/SCLCR/L ..	Boring Bars SET	Bohstangen Set	96
A/SDUCR/L ..	Boring Bars SET	Bohstangen Set	99
AAKT-IG-R/L ..	Face External Grooving Tool Holders	Axial Stechhalter	164
AAKT-KG-R/L ..	Face External Grooving Tool Holders	Axial Stechhalter	163
AAKT-K-R/L ..	Face External Grooving Tool Holders	Axial Stechhalter	162
AAKT-SGC-T-R/L ..	Face External Grooving Tool Holders	Axial Stechhalter	164
AAKT-WGX24-T-R/L ..	Face External Grooving Tool Holders	Axial Stechhalter	165
AAKT-ZCC2-R/L ..	Face External Grooving Tool Holders	Axial Stechhalter	163
ABHF ..	Adjustable Finish Boring Heads	EINSTELLBARE BOHRKÖPFE	227
ABHR ..	Adjustable Rough Boring Heads	EINSTELLBARE SPINDELKÖPFE	231
ABHRS ..	Adjustable Rough Boring Heads Body	TRÄGERWERKZEUGE FÜR EINSTELLBARE SCHRUPP-SPINDELKÖPFE	232
ACBM ..	Countersink Open Milling Tools	Senkwerkzeuğf.Zylinderkopf-schrauben	239
ACM ..	Chamfering End Mills	Fasfräser	237
ACM45-SP..	Chamfering End Mills	Fasfräser	238
ACPBT..	Pipe Beveling Tools	Rohrendenanaswerkzeug	131
ADCR	Drill Chamfering Ring Tools	Rohrendenanaswerkzeug	218
ADKT-123-R/L ..	External Grooving Tool Holders	Außen - Stechhalter	149
ADKT-123-S-R/L ..	External Grooving (Swiss Type) Tool Holders	Außen - Stechhalter (SwissType)	161
ADKT-151.22-R/L ..	External Grooving Tool Holders	Außen - Stechhalter	150
ADKT-151.23-R/L ..	External Grooving Tool Holders	Außen - Stechhalter	150
ADKT-154.91-R/L ..	External Grooving Tool Holders	Außen - Stechhalter	151
ADKT-ARN-R/L ..	External Grooving Tool Holders	Außen - Stechhalter	151
ADKT-CD-R/L ..	External Grooving Tool Holders	Außen - Stechhalter	157
ADKT-GB-R/L ..	External Grooving Tool Holders	Außen - Stechhalter	154
ADKT-GP-R/L ..	External Grooving Tool Holders	Außen - Stechhalter	156
ADKT-GY2-R/L ..	External Grooving Tool Holders	Außen - Stechhalter	157
ADKT-H22-R/L ..	External Grooving Tool Holders	Außen - Stechhalter	154
ADKT-HK-R/L ..	External Grooving Tool Holders	Außen - Stechhalter	145
ADKT-H-R/L ..	External Grooving Tool Holders	Außen - Stechhalter	144
ADKT-HS223 R/L ..	External Grooving Tool Holders	Außen - Stechhalter	145
ADKT-IDC-R/L ..	External Grooving Tool Holders	Außen - Stechhalter	148
ADKT-IGI-R/L ..	External Grooving Tool Holders	Außen - Stechhalter	148
ADKT-IG-R/L ..	External Grooving Tool Holders	Außen - Stechhalter	148
ADKT-IGTN-R/L ..	External Grooving Tool Holders	Außen - Stechhalter	148
ADKT-I-R/L ..	External Grooving Tool Holders	Außen - Stechhalter	148
ADKT-I-R/L ..S	External Grooving (Swiss Type) Tool Holders	Außen - Stechhalter (SwissType)	159
ADKT-ITG-R/L ..	External Grooving Tool Holders	Außen - Stechhalter	147
ADKT-KG-R/L ..	External Grooving Tool Holders	Außen - Stechhalter	143
ADKT-KG-R/L ..S	External Grooving (Swiss Type) Tool Holders	Außen - Stechhalter (SwissType)	160
ADKT-KM-R/L ..	External Grooving Tool Holders	Außen - Stechhalter	147
ADKT-K-R/L ..	External Grooving Tool Holders	Außen - Stechhalter	142
ADKT-K-R/L .. -H	External Grooving Tool Holders With Coolant Tools	Externe Nutwerkzeughalter Mit Kühlwerkzeug	143
ADKT-K-R/L ..S	External Grooving (Swiss Type) Tool Holders	Außen - Stechhalter (SwissType)	160
ADKT-LGC-R/L ..	External Grooving Tool Holders	Außen - Außen - Stechhalter	153

KOD / CODE	AÇIKLAMA / DESCRIPTION	BESCHREIBUNG	SN. / PN. SEITE
ADKT-RD-R/L ..	External Grooving Tool Holders	Außen - Stechhalter	153
ADKT-RD-R/L .. -S	External Grooving (Swiss Type) Tool Holders	Außen - Stechhalter (SwissType)	158
ADKT-SGC-T-R/L ..	Face External Grooving Tool Holders	Axial Stechhalter	164
ADKT-SWC-R/L ..	External Grooving Tool Holders	Außen - Stechhalter	157
ADKT-TD-R/L ..	External Grooving Tool Holders	Außen - Stechhalter	152
ADKT-TD-R/L ..S	External Grooving (Swiss Type) Tool Holders	Außen - Stechhalter (Swiss Type)	158
ADKT-TD-R/L..-H	External Grooving Tool Holders With Coolant Tools	Externe Nutwerkzeughalter Mit Kühlwerkzeug	152
ADKT-TG-R/L ..	External Grooving Tool Holders	Außen - Stechhalter	155
ADKT-TGF-R/L ..	External Grooving Tool Holders	Außen - Stechhalter	155
ADKT-TG-R/L .. -S	External Grooving (Swiss Type) Tool Holders	Außen - Stechhalter (SwissType)	161
ADKT-WGX..R/L ..	External Grooving Tool Holders	Außen - Stechhalter	156
ADKT-WGX..R/L ..S	External Grooving (Swiss Type) Tool Holders	Außen - Stechhalter (SwissType)	161
ADKT-ZCC1-R/L ..	External Grooving Tool Holders	Außen - Stechhalter	145
ADKT-ZCC2-R/L ..	External Grooving Tool Holders	Außen - Stechhalter	146
ADKT-ZCC2-R/L ..S	External Grooving (Swiss Type) Tool Holders	Außen - Stechhalter (SwissType)	159
AEKR/L ..	Economic Cutting Tools	Multifunktionales Werkzeug	224
AEM90-3P..	End Mills	Schafffräser	266
AEM90-3P..	Modular End Mills	Einschraubfräser	287
AEM90-4N..	End Mills	Schafffräser	266
AEM90-AD..	End Mills	Schafffräser	240
AEM90-AD..	Modular End Mills	Einschraubfräser	282
AEM90-AN..	End Mills	Schafffräser	242
AEM90-AO..	End Mills	Schafffräser	249
AEM90-AO..	Modular End Mills	Einschraubfräser	283
AEM90-AP..	End Mills	Schafffräser	244
AEM90-AP..	Modular End Mills	Einschraubfräser	283
AEM90-AX..	End Mills	Schafffräser	250
AEM90-AX..	Modular End Mills	Einschraubfräser	282
AEM90-AZ..	End Mills	Schafffräser	252
AEM90-BD..	End Mills	Schafffräser	253
AEM90-BD.. -H	Modular End Mills ( Screw Type Tools )	Einschraubfräser	253
AEM90-DC..	Modular End Mills	Einschraubfräser	284
AEM90-ED..	End Mills	Schafffräser	254
AEM90-LO-H..	End Mills	Schafffräser	256
AEM90-LO	End Mills	Schafffräser	257
AEM90-LN..	End Mills	Schafffräser	255
AEM90-R390..	End Mills	Schafffräser	257
AEM90-R390..	Modular End Mills	Einschraubfräser	258
AEM90-RT..	End Mills	Schafffräser	258
AEM90-RT..	Modular End Mills	Einschraubfräser	285
AEM90-SE..	End Mills	Schafffräser	259
AEM90-SO..	End Mills	Schafffräser	259
AEM90-SPGT..	End Mills	Schafffräser	261
AEM90-TNG..	End Mills	Schafffräser	286
AEM90-TNG.. -H	Modular End Mills ( Screw Type Tools )	Einschraubfräser	260
AEM90-VC2205.. -H	End Mills	Schafffräser	261

KOD / CODE	AÇIKLAMA / DESCRIPTION	BESCHREIBUNG	S.N. / PN. SEITE	KOD / CODE	AÇIKLAMA / DESCRIPTION	BESCHREIBUNG	S.N. / PN. SEITE
AEM90-WN..	End Mills	Schaftfräser	262	AFM88-SN..	Face Milling	Plan-und Eckmesserköpfe	325
AEM90-WN..	Modular End Mills	Einschraubfräser	262	AFM89-SN..	Face Milling	Plan-und Eckmesserköpfe	328
AEM90-WNG.. -H	End Mills	Schaftfräser	262	AFM90(L)-LN..	Face Milling	Plan-und Eckmesserköpfe	335
AEM90-XC..	End Mills	Schaftfräser	263	AFM90(S)-SD..	Face Milling	Plan-und Eckmesserköpfe	342
AEM90-XD..	End Mills	Schaftfräser	263	AFM90-3P..	Face Milling	Plan-und Eckmesserköpfe	350
AEM90-XN..-H	Modular End Mills ( Screw Type Tools )	Einschraubfräser	287	AFM90-490..	Face Milling	Plan-und Eckmesserköpfe	341
AEM90-XN..	End Mills	Schaftfräser	264	AFM90-4N..	Face Milling	Plan-und Eckmesserköpfe	350
AEM90-XO..	End Mills	Schaftfräser	264	AFM90-6N..	Face Milling	Plan-und Eckmesserköpfe	351
AEM90-ZC..	End Mills	Schaftfräser	265	AFM90-AD..	Face Milling	Plan-und Eckmesserköpfe	329
AEM90-ZP..	End Mills	Schaftfräser	265	AFM90-AN..	Face Milling	Plan-und Eckmesserköpfe	330
AEM95(C)-XD..	Modular End Mills	Einschraubfräser	288	AFM90-AO..	Face Milling	Plan-und Eckmesserköpfe	335
AEMR(C)-RD..	Face and Copy End Mills	Kopier - und Schaftfräser	269	AFM90-AP..	Face Milling	Plan-und Eckmesserköpfe	332
AEMR-QP..	Face and Copy Mills	Kopier - und Schaftfräser	270	AFM90-AX..	Face Milling	Plan-und Eckmesserköpfe	333
AEMR-QP..	Modular End Mills	Einschraubfräser	293	AFM90-BD..	Face Milling	Plan-und Eckmesserköpfe	334
AEMR-RC..	Modular End Mills	Einschraubfräser	291	AFM90C-TP..	Face Milling	Plan-und Eckmesserköpfe	359
AEMR-RD..	Face and Copy Mills	Kopier - und Schaftfräser	269	AFM90-LO..	Face Milling	Plan-und Eckmesserköpfe	339
AEMR-RD..	Modular End Mills	Einschraubfräser	291	AFM90-LO..-H	Face Milling	Plan-und Eckmesserköpfe	334
AEMR-RP..	Face and Copy Mills	Kopier - und Schaftfräser	267	AFM90-R290..	Face Milling	Plan-und Eckmesserköpfe	340
AEMR-RP..	Modular End Mills	Einschraubfräser	289	AFM90-R390..	Face Milling	Plan-und Eckmesserköpfe	340
AEMR-RP..	Modular End Mills ( Screw Type Tools )	Einschraubfräser	292	AFM90-RT..	Face Milling	Plan-und Eckmesserköpfe	341
AEMR-RY..	Face and Copy End Mills	Kopier - und Schaftfräser	268	AFM90-SE..	Face Milling	Plan-und Eckmesserköpfe	343
AEMR-RY..	Modular End Mills	Einschraubfräser	290	AFM90-SP..	Face Milling	Plan-und Eckmesserköpfe	344
AEMRC-RD..	Modular End Mills ( Screw Type Tools )	Einschraubfräser	290	AFM90-TN..	Face Milling	Plan-und Eckmesserköpfe	345
AET	Eccentric Adaptör For U-Drill	Exzentrischer Adapter für Vollbohrer	220	AFM90-TP..	Face Milling	Plan-und Eckmesserköpfe	346
AFM40-NN..	Face Milling	Plan-und Eckmesserköpfe	315	AFM90-VC2205.. -H	Face Milling	Plan-und Eckmesserköpfe	347
AFM42C-XD..	Face Milling	Plan-und Eckmesserköpfe	312	AFM90-WN..	Face Milling	Plan-und Eckmesserköpfe	348
AFM43(C)-OD..	Face Milling	Plan-und Eckmesserköpfe	312	AFM90-WNG0.. -H	Face Milling	Plan-und Eckmesserköpfe	347
AFM43(C)-OF..	Face Milling	Plan-und Eckmesserköpfe	313	AFM90-XN..	Face Milling	Plan-und Eckmesserköpfe	349
AFM43-ON..	Face Milling	Plan-und Eckmesserköpfe	314	AFM90-XO..	Face Milling	Plan-und Eckmesserköpfe	349
AFM44-ON..	Face Milling	Plan-und Eckmesserköpfe	314	AFMR(C)-RD..	Face and Copy Milling	Kopier - und Schaftfräser	353
AFM45(L)-HN..	Face Milling	Plan-und Eckmesserköpfe	315	AFMR(C)-RO..	Face and Copy Milling	Kopier - und Schaftfräser	354
AFM45(L)-SE..	Face Milling	Plan-und Eckmesserköpfe	316	AFMR-QP..	Face and Copy Milling	Kopier - und Schaftfräser	356
AFM45(S)-SE	Face Milling	Plan-und Eckmesserköpfe	316	AFMR-RC..	Face and Copy Milling	Kopier - und Schaftfräser	352
AFM45-SE..	Face Milling	Plan-und Eckmesserköpfe	317	AFMR-RP..	Face and Copy Milling	Kopier - und Schaftfräser	355
AFM45C(L)-HN..	Face Milling	Plan-und Eckmesserköpfe	357	AFMR-RY..	Face and Copy Milling	Kopier - und Schaftfräser	255
AFM45C(L)-SN..	Face Milling	Plan-und Eckmesserköpfe	319	AHFM(C)-JD..	High Feed Milling Tools	Hochvorschubfräser	297
AFM45C-ON..	Face Milling	Plan-und Eckmesserköpfe	322	AHFM(C)-SD..	High Feed End Mills	Hochvorschubschafffräser	366
AFM45C-XN..	Face Milling	Plan-und Eckmesserköpfe	357	AHFM(C)-SD..	High Feed Milling Tools	Hochvorschubfräser	279
AFM45-NN..	Face Milling	Plan-und Eckmesserköpfe	316	AHFM(C)-SD..	Modular High Feed End Mills	Hochvorschubeinschraubfräser	299
AFM45-ON..	Face Milling	Plan-und Eckmesserköpfe	321	AHFM(C)-WD..	High Feed End Mills	Hochvorschubschafffräser	279
AFM45S-SE..	Face Milling	Plan-und Eckmesserköpfe	318	AHFM(C)-WD..	High Feed Milling Tools	Hochvorschubfräser	280
AFM45-SA..	Face Milling	Plan-und Eckmesserköpfe	320	AHFM(L)-WN..	High Feed Milling Tools	Hochvorschubfräser	361
AFM45-SN..	Face Milling	Plan-und Eckmesserköpfe	323	AHFM-BL..	High Feed End Mills	Hochvorschubschafffräser	276
AFM45-XN..	Face Milling	Plan-und Eckmesserköpfe	322	AHFM-BL..	High Feed Milling Tools	Hochvorschubfräser	360
AFM66-PN..	Face Milling	Plan-und Eckmesserköpfe	323	AHFM-BL..	Modular High Feed End Mills	Hochvorschubfräser	293
AFM67-PN..	Face Milling	Plan-und Eckmesserköpfe	324	AHFM-BN..	High Feed End Mills	Hochvorschubschafffräser	270
AFM75-AP..	Face Milling	Plan-und Eckmesserköpfe	324	AHFM-C-JD..	High Feed End Mills	Hochvorschubschafffräser	364
AFM75C-SP..	Face Milling	Plan-und Eckmesserköpfe	358	AHFM-C-JD..	Modular High Feed End Mills	Hochvorschubfräser	297
AFM75-XO..	Face Milling	Plan-und Eckmesserköpfe	325	AHFM-C-WD..	Modular High Feed End Mills	Hochvorschubfräser	302
AFM88C-SN..	Face Milling	Plan-und Eckmesserköpfe	326	AHFM-ED..	Modular High Feed End Mills	Hochvorschubfräser	294

KOD / CODE	AÇIKLAMA / DESCRIPTION	BESCHREIBUNG	S.N. / P.N. SEITE
AHFM-EN..	High Feed End Mills	Hochvorschubschafffräser	273
AHFM-EN..	High Feed Milling Tools	Hochvorschubfräser	360
AHFM-EN..	Modular High Feed End Mills	Hochvorschubfräser	295
AHFM-EO..	High Feed End Mills	Hochvorschubschafffräser	271
AHFM-EP..	High Feed End Mills	Hochvorschubschafffräser	271
AHFM-EP..	High Feed Milling Tools	Hochvorschubfräser	271
AHFM-EP..	Modular High Feed End Mills	Hochvorschubfräser	294
AHFM-JD..	High Feed Milling Tools	Hochvorschubfräser	362
AHFM-JD..	Modular High Feed End Mills	Hochvorschubfräser	296
AHFM-LN..	High Feed End Mills	Hochvorschubschafffräser	275
AHFM-LN..	Modular High Feed End Mills	Hochvorschubfräser	295
AHFM-LN0303.. -H	Modular End Mills	Einschraubfräser	362
AHFM-LN0303.. -H	Modular ( Screw Type ) Highfeed End Mills	Einschraubfräser	295
AHFM-LN0303.. -H	High Feed Milling Tools	Hochvorschubfräser	275
AHFM-LO..	High Feed End Mills	Hochvorschubschafffräser	275
AHFM-LO..	High Feed Milling Tools	Hochvorschubfräser	361
AHFM-LO..	Modular High Feed End Mills	Hochvorschubeinschraubfräser	296
AHFM-LP..	High Feed End Mills	Hochvorschubschafffräser	276
AHFM-SD..	Modular High Feed End Mills	Hochvorschubfräser	297
AHFM-SO..	High Feed End Mills	Hochvorschubschafffräser	277
AHFM-SO..	High Feed Milling Tools	Hochvorschubschafffräser	365
AHFM-SO..	Modular High Feed End Mills	Hochvorschubfräser	300
AHFM-SP..	High Feed End Mills	Hochvorschubschafffräser	274
AHFM-SP..	High Feed Milling Tools	Hochvorschubfräser	363
AHFM-SP..	Modular High Feed End Mills	Hochvorschubfräser	298
AHFM-SP-H..	High Feed End Mills	Hochvorschubschafffräser	274
AHFM-WN..	High Feed End Mills	Hochvorschubschafffräser	280
AHFM-WN..	Modular High Feed End Mills	Hochvorschubfräser	281
AHFM-WO..	High Feed End Mills	Hochvorschubschafffräser	281
AHFM-YO..	High Feed End Mills	Hochvorschubschafffräser	279
AHFM-YP..	High Feed End Mills	Hochvorschubschafffräser	278
AHFM-YP..	Modular High Feed End Mills	Hochvorschubfräser	301
AHFM-JO..	High Feed End Mills	Hochvorschubschafffräser	363
AHM ..	Helix Chamfer Milling Tools	Helix-Fasfräser	238
AHM90-AP..	Helix End Mills	Wendelschafffräser	311
AHM90-AP1204.. -H	Helix End Mills	Wendelschafffräser	310
AIKT-123..-R/L ..	Internal Grooving Tool Holders	Innen - Stechhalter	176
AIKT-151..-R/L ..	Internal Grooving Tool Holders	Innen - Stechhalter	176
AIKT-154.91-R/L ..	Internal Grooving Tool Holders	Innen - Stechhalter	177
AIKT-GP-R/L ..	Internal Grooving Tool Holders	Innen - Stechhalter	181
AIKT-HK-R/L ..	Internal Grooving Tool Holders	Innen - Stechhalter	189
AIKT-H-R/L ..	Internal Grooving Tool Holders	Innen - Stechhalter	174
AIKT-HS223-R/L ..	Internal Grooving Tool Holders	Innen - Stechhalter	175
AIKT-IGE-R/L ..	Internal Grooving Tool Holders	Innen - Stechhalter	178
AIKT-IGI-R/L ..	Internal Grooving Tool Holders	Innen - Stechhalter	179
AIKT-IG-R/L ..	Internal Grooving Tool Holders	Innen - Stechhalter	180
AIKT-I-R/L ..	Internal Grooving Tool Holders	Innen - Stechhalter	179
AIKT-ITG-R/L ..	Internal Grooving Tool Holders	Innen - Stechhalter	180
AIKT-KG-R/L ..	Internal Grooving Tool Holders	Innen - Stechhalter	174
AIKT-KM-R/L ..	Internal Grooving Tool Holders	Innen - Stechhalter	175

KOD / CODE	AÇIKLAMA / DESCRIPTION	BESCHREIBUNG	S.N. / P.N. SEITE
AIKT-K-R/L ..	Internal Grooving Tool Holders	Innen - Stechhalter	173
AIKT-MB..	Mini Grooving Tool	Mini - Stechwerkzeuge	183
AIKT-QC..-R/L ..	Internal Grooving Tool Holders	Innen - Stechhalter	182
AIKT-RD-R/L ..	Internal Grooving Tool Holders	Innen - Stechhalter	177
AIKT-SGC-R ..	Internal Grooving Tool Holders	Innen - Stechhalter	183
AIKT-TD-R/L ..	Internal Grooving Tool Holders	Innen - Stechhalter	178
AIKT-TG-R/L ..	Internal Grooving Tool Holders	Innen - Stechhalter	181
AIKT-ZCC2-R/L ..	Internal Grooving Tool Holders	Innen - Stechhalter	182
AKCR ..	Adjustable Rough Boring Heads Cartridge	Einstellbare Schrupp - Spindelkopf Kurzdrehhalter	233
AKL-123 ..	Blades	Stechschwert	167
AKL-K ..	Blades	Stechschwert	168
AKL-SP ..	Blades	Stechschwert	169
AKL-SX ..	Blades	Stechschwert	169
AKL-ZCC2 ..	Blades	Stechschwert	168
AKL-I ..	Blades	Stechschwert	167
AKL-SGC ..	Blades	Stechschwert	166
AKL-TD ..	Blades	Stechschwert	166
AKSR ..	Adjustable Rough Boring Heads Cartridge	EINSTELLBARE SPINDELKÖPFE	233
ALBU ..	Blocks For Blades	Spannblock für Stechschwert	170
ALBU-H ..	Blocks For Blades	Spannblock für Stechschwert	170
ALKT-ZCC2-R/L ..	Face External Grooving Tool Holders	Axial Stechhalter	165
APMR-BNM..	Ball Nose End Mills	Kopier-Schafffräser	304
APMR-BNM.. -H	Modular ( Screw Type ) End Mills	Einschraubfräser	306
APMR-P32..	Ball Nose End Mills	Kopier-Schafffräser	305
APMR-P32..	Ball Nose Modular End Mills	Modulare Einschraub - Kugelfräser	306
APMR-RO..	Ball Nose End Mills	Kopier-Schafffräser	304
APMR-SWB..	Ball Nose Modular End Mills	Modulare Einschraub - Kugelfräser	307
APMR-XP..	Ball Nose End Mills	Kopier-Schafffräser	305
APMR-XP..	Ball Nose Modular End Mills	Modulare Einschraub - Kugelfräser	307
ASDM-CC..	Disc Milling	Scheibenfräser	372
ASDM-SPGT..	Disc Milling	Scheibenfräser	371
ASTB-..	Swiss Easy Change Tools	Swiss Easy Change Tools	70
ATM..	Thread Milling Tools	Gewindefräswerkzeuge	308
ATM-3BEI..	Thread Milling Tools	Gewindefräswerkzeuge	309
ATM60..	Thread Milling Tools	Gewindefräswerkzeuge	310
ATSM90-CC..	T Slot Milling	T Nutenfräser	369
ATSM90-SP..	T Slot Milling	T Nutenfräser	370
ATSMR-RD..	T Slot Milling	T Nutenfräser	370
ATTB ..	Anti Vibration Tool	Schwingungsgedämpfte Bohrstangen	115
ATTC ..	Anti Vibration Tool	Schwingungsgedämpfte Bohrstangen	116
ATTC- .. SCLCR/L ..	Anti Vibration Tool	Schwingungsgedämpfte Bohrstangen	116
ATTC- .. SDUCR/L ..	Anti Vibration Tool	Schwingungsgedämpfte Bohrstangen	132
ATTC- .. SVUCR/L ..	Anti Vibration Tool	Schwingungsgedämpfte Bohrstangen	117
ATTC- .. TCLNR/L ..	Anti Vibration Tool	Schwingungsgedämpfte Bohrstangen	118

KOD / CODE	AÇIKLAMA / DESCRIPTION	BESCHREIBUNG	S.N. / P.N. SEITE	KOD / CODE	AÇIKLAMA / DESCRIPTION	BESCHREIBUNG	S.N. / P.N. SEITE
ATTC- .. TDUNR/L ..	Anti Vibration Tool	Schwingungsgedämpfte Bohrstrangen	117	MTQNR/L ..	Internal Tool Holders	Außen-Drehhalter	86
ATUM .. xD2 KDR ..	U-Drill	Vollbohrer	210	MTUNR/L ..	Internal Tool Holders	Außen-Drehhalter	86
ATUM .. xD2 SP ..	U-Drill	Vollbohrer	195	MWLNRL/L ..	External Tool Holders	Außen-Drehhalter	31
ATUM .. xD2 SPGT ..	U-Drill	Vollbohrer	201	MwLNRL/L ..	Internal Tool Holders	Außen-Drehhalter	87
ATUM .. xD2 WCM ..	U-Drill	Vollbohrer	188	MWMNN ..	External Tool Holders	Außen-Drehhalter	31
ATUM .. xD3 KDR ..	U-Drill	Vollbohrer	211	PCBNR/L ..	External Tool Holders	Außen-Drehhalter	33
ATUM .. xD3 SO ..	U-Drill	Vollbohrer	208	PCLNR/L ..	External Tool Holders	Außen-Drehhalter	33
ATUM .. xD3 SP ..	U-Drill	Vollbohrer	198	PCLNR/L ..	Internal Tool Holders	Außen-Drehhalter	89
ATUM .. xD3 SPGT ..	U-Drill	Vollbohrer	202	PCLNR/L.. -H	External Turning Toolholders With Coolant Tools	Außen-Drehhalter INNENKÜHLUNG	34
ATUM .. xD3 WCM ..	U-Drill	Vollbohrer	190	PCMNN ..	External Tool Holders	Außen-Drehhalter	34
ATUM .. xD4 KDR ..	U-Drill	Vollbohrer	210	PDJNR/L ..	External Tool Holders	Außen-Drehhalter	35
ATUM .. xD4 SO ..	U-Drill	Vollbohrer	209	PDJNR/L .. -H	External Turning Toolholders With Coolant Tools	Außen-Drehhalter INNENKÜHLUNG	35
ATUM .. xD4 SP ..	U-Drill	Vollbohrer	199	PDNNN ..	External Tool Holders	Außen-Drehhalter	36
ATUM .. xD4 SPGT ..	U-Drill	Vollbohrer	204	PDNNN-H	External Turning Toolholders With Coolant Tools	Außen-Drehhalter INNENKÜHLUNG	36
ATUM .. xD4 WCM ..	U-Drill	Vollbohrer	192	PDQNR/L ..	Internal Tool Holders	Außen-Drehhalter	90
ATUM .. xD5 SP ..	U-Drill	Vollbohrer	200	PDUNR/L ..	Internal Tool Holders	Außen-Drehhalter	91
ATUM .. xD5 WCM ..	U-Drill	Vollbohrer	194	PDXNR/L ..	Internal Tool Holders	Außen-Drehhalter	90
ATUM xD2 SO ..	U-Drill	Vollbohrer	207	PSBNR/L ..	External Tool Holders	Außen-Drehhalter	37
ATUM xD2 SOMT ..	U-Drill	Vollbohrer	212	PSDNN ..	Cartridge	Kassette	130
ATUM xD3 880 ..	U-Drill	Vollbohrer	216	PSDNN ..	External Tool Holders	Außen-Drehhalter	37
ATUM xD3 SO ..	U-Drill	Vollbohrer	208	PSKNR/L ..	Cartridge	Kassette	128
ATUM xD3 SOMT ..	U-Drill	Vollbohrer	213	PSKNR/L ..	External Tool Holders	Außen-Drehhalter	38
ATUM xD4 SO ..	U-Drill	Vollbohrer	209	PSKNR/L ..	Internal Tool Holders	Außen-Drehhalter	92
ATUM xD4 SOMT ..	U-Drill	Vollbohrer	214	PSRNR/L ..	Cartridge	Kassette	129
ATUM xD5 SOMT ..	U-Drill	Vollbohrer	215	PSSNR/L ..	External Tool Holders	Außen-Drehhalter	38
ATUM xD5 SPGT ..	U-Drill	Vollbohrer	204	PTFNR/L ..	Cartridge	Kassette	129
AVTT..	Screwed Tool Holders	Aufnahme für Einschraubfräser	308	PTFNR/L ..	External Tool Holders	Außen-Drehhalter	39
CCLNR/L ..	External Tool Holders	Außen-Drehhalter	45	PTGNR/L ..	External Tool Holders	Außen-Drehhalter	39
CDJNR/L ..	External Tool Holders	Außen-Drehhalter	46	PTGNR/L ..	Cartridge	Kassette	129
CDNNN ..	External Tool Holders	Außen-Drehhalter	46	PTJNR/L ..	External Tool Holders	Außen-Drehhalter	40
CKJNR/L ..	External Tool Holders	Außen-Drehhalter	45	PTTNR/L ..	External Tool Holders	Außen-Drehhalter	40
CKUNR/L ..	Internal Tool Holders	Außen-Drehhalter	98	PTUNR/L ..	Internal Tool Holders	Außen-Drehhalter	93
CRDCN ..	External Tool Holders	Außen-Drehhalter	47	PwLNRL/L ..	External Tool Holders	Außen-Drehhalter	41
CRDCR/L ..	External Tool Holders	Außen-Drehhalter	48	PwLNRL/L ..	Internal Tool Holders	Außen-Drehhalter	94
CSDNN ..	External Tool Holders	Außen-Drehhalter	48	PwLNRL/L ..-H	External Turning Toolholders With Coolant Tools	Interne Kühlung Aussen - Drehhalter	41
CSKNR/L ..	External Tool Holders	Außen-Drehhalter	49	PDJCR/L.. -H	External Tool Holders Swiss Type	Außen-Drehhalter Swiss Type	42
CSRNR/L ..	External Tool Holders	Außen-Drehhalter	49	S/SCLCR/L ..	Boring Bars SET	Bohrstangen Set	111
CSSNR/L ..	External Tool Holders	Außen-Drehhalter	50	S/SDUCR/L ..	Boring Bars SET	Bohrstangen Set	112
CTFPR/L ..	Boring Bars	Bohrstangen	82	SCACR/L ..	Engine Overhaul Cartridge	Motorüberholungskassette	123
CTJNR/L ..	External Tool Holders	Außen-Drehhalter	50	SCACR/L ..	External Tool Holders	Außen-Drehhalter	51
E/SCLCR/L ..	Boring Bars SET	Bohrstangen Set	111	SCACR/L ..-S	External Tool Holders Swiss Type	Außen-Drehhalter Swiss Type	66
E/SDUCR/L ..	Boring Bars SET	Bohrstangen Set	112	SCFCR/L	Spare Parts Of Cartridge	Ersatzteile für Kassette	130
E/STFCR/L ..	Boring Bars	Bohrstangen	112	SCFCR/L ..	Cartridge	Kassette	125
E/STUPR/L ..	Boring Bars	Bohrstangen	110	SCFCR/L ..	Internal Tool Holders	Außen-Drehhalter	97
MCLNR/L ..	Internal Tool Holders	Außen-Drehhalter	84	SCLCR/L ..	Boring Bars With Carbide Shank	Bohrstangen mit Hartmetall-schaft	109
MDUNR/L ..	Internal Tool Holders	Außen-Drehhalter	84	SCLCR/L ..	External Tool Holders	External Tool Holders	52
MTENN ..	External Tool Holders	Außen-Drehhalter	30	SCLCR/L ..-SHP	External Tool Holders	External Tool Holders	53
MTFNR/L ..	Internal Tool Holders	Außen-Drehhalter	85	SCLCR/L ..	Internal Tool Holders	Außen-Drehhalter	96
MTJNR/L ..	External Tool Holders	Außen-Drehhalter	30				
MT-NR/L ..	Internal Tool Holders	Außen-Drehhalter	85				

KOD / CODE	AÇIKLAMA / DESCRIPTION	BESCHREIBUNG	S.N. / P.N. SEITE
SCLCR/L ..-S	External Tool Holders Swiss Type	Außen-Drehhalter Swiss Type	66
SCMCN ..	Engine Overhaul Cartridge	Хонингованные Kasette	124
SCMCN ..	External Tool Holders	Außen-Drehhalter	53
SCSCR/L	Spare Parts Of Cartridge	Ersatzteile für Kasette	130
SCSCR/L ..	Cartridge	Kasette	126
SDACR/L ..-S	External Tool Holders Swiss Type	Außen-Drehhalter Swiss Type	67
SD-CR/L ..	Internal Tool Holders	Außen-Drehhalter	97
SDHCR/L ..	External Tool Holders	Außen-Drehhalter	54
SDJCR/L ..	External Tool Holders	Außen-Drehhalter	54
SDJCR/L ..	Sec Tools	Sec Tools	71
SDJCR/L ..-S	External Tool Holders Swiss Type	Außen-Drehhalter Swiss Type	67
SDJCR/L ..-SHP	External Tool Holders	Außen-Drehhalter	55
SDJCR/L ..	Swiss Easy Change Tools	Swiss Easy Change Tools	71
SDNCN ..	External Tool Holders	Außen-Drehhalter	55
SDPCR/L ..	Internal Tool Holders	Außen-Drehhalter	98
SDQCR/L ..	Internal Tool Holders	Außen-Drehhalter	98
SDUCR/L ..	Boring Bars With Carbide Shank	Bohrstangen mit Hartmetallschaft	109
SDUCR/L ..	Internal Tool Holders	Außen-Drehhalter	99
SDXCR/L ..	Internal Tool Holders	Außen-Drehhalter	100
SER/L ..	External Threading Tool Holders	Sec Tools	134
SER/L ..	Sec Tools	Sec Tools	72
SIR/L ..	Internal Threading Tool Holders	Werkzeughalter für Innengewinde	135
SRDCN ..	External Tool Holders	Außen-Drehhalter	56
SRDCR/L ..	External Tool Holders	Außen-Drehhalter	57
SRGCR/L ..	External Tool Holders	Außen-Drehhalter	57
SRGCR/L ..	Internal Tool Holders	Außen-Drehhalter	101
SRHCR/L ..	External Tool Holders	Außen-Drehhalter	58
SRSCN..	Engine Overhaul Cartridge	Motorüberholungskasette	124
SRXCR/L ..	External Tool Holders	Außen-Drehhalter	58
SSDCN ..	External Tool Holders	Außen-Drehhalter	59
SSKCR/L ..	Cartridge	Kasette	126
SSSCR/L ..	External Tool Holders	Außen-Drehhalter	59
SSSCR/L ..	Internal Tool Holders	Außen-Drehhalter	101
STCCN ..	External Tool Holders	Außen-Drehhalter	61
ST-CR/L ..	Internal Tool Holders	Außen-Drehhalter	102
STFCR/L	Spare Parts Of Cartridge	Ersatzteile für Kasette	130
STFCR/L ..	Cartridge	Kasette	127
STFCR/L ..	External Tool Holders	Außen-Drehhalter	60
STFCR/L ..	Internal Tool Holders	Außen-Drehhalter	102
STFPR/L ..	Finish Boring Heads Cartridge	FERTIGBOHRKÖPFE UND KARTUSCHEN	229
STGCR/L ..	External Tool Holders	Außen-Drehhalter	60
STGCR/L ..-S	External Tool Holders Swiss Type	Außen-Drehhalter Swiss Type	68
STJCR/L ..	External Tool Holders	Außen-Drehhalter	61
STSCR/L	Spare Parts Of Cartridge	Ersatzteile für Kasette	130
STSCR/L ..	Cartridge	Kasette	127
STTCR/L	Spare Parts Of Cartridge	Ersatzteile für Kasette	130
STTCR/L ..	Cartridge	Kasette	128
STUCR/L ..	External Tool Holders	Außen-Drehhalter	62
STUCR/L ..	Internal Tool Holders	Außen-Drehhalter	103
STUPR/L ..	Internal Tool Holders	Außen-Drehhalter	104

KOD / CODE	AÇIKLAMA / DESCRIPTION	BESCHREIBUNG	S.N. / P.N. SEITE
STUPR/L ..	Finish Boring Heads Cartridge	FERTIGBOHRKÖPFE UND KARTUSCHEN	228
STXCR/L ..	Engine Overhaul Cartridge	Motorüberholungskasette	125
SVACR/L ..-S	External Tool Holders Swiss Type	Außen-Drehhalter Swiss Type	69
SVHBR/L ..	External Tool Holders	Außen-Drehhalter	62
SVHCR/L ..	External Tool Holders	Außen-Drehhalter	63
SVJBR/L ..	External Tool Holders	Außen-Drehhalter	63
SVJBR/L ..	Internal Tool Holders	Außen-Drehhalter	104
SVJBR/L ..-S	External Tool Holders Swiss Type	Außen-Drehhalter Swiss Type	69
SVJCR/L	Swiss Easy Change Tools	Swiss Easy Change Tools	71
SVJCR/L ..	External Tool Holders	Außen-Drehhalter	64
SVJCR/L ..	Internal Tool Holders	Außen-Drehhalter	107
SVJCR/L ..	Sec Tools	Sec Tools	71
SVJCR/L ..-S	External Tool Holders Swiss Type	Außen-Drehhalter Swiss Type	70
SVQBR/L ..	Internal Tool Holders	Außen-Drehhalter	105
SVQCR/L ..	Internal Tool Holders	Außen-Drehhalter	105
SVUBR/L ..	Internal Tool Holders	Außen-Drehhalter	106
SVUCR/L ..	Internal Tool Holders	Außen-Drehhalter	106
SVVBN ..	External Tool Holders	Außen-Drehhalter	65
SVVCN ..	External Tool Holders	Außen-Drehhalter	65
SVXBR/L ..	Internal Tool Holders	Außen-Drehhalter	107
SVJCR/L ..-SHP	External Tool Holders	Außen-Drehhalter	64
SWLCR ..	Internal Tool Holders	Außen-Drehhalter	108
SWLCR ..	Finish Boring Heads Cartridge	FERTIGBOHRKÖPFE UND KARTUSCHEN	228
SWUBR ..	Internal Tool Holders	Außen-Drehhalter	108
TCBNR/L ..	External Tool Holders	Außen-Drehhalter	13
TCBNR/L ..-H	External Tool Holders	Außen-Drehhalter	13
TCKNR/L ..	External Tool Holders	Außen-Drehhalter	14
TCKNR/L ..-H	External Tool Holders	Außen-Drehhalter	14
TCLNR/L ..	External Tool Holders	Außen-Drehhalter	15
TCLNR/L ..-H	External Tool Holders	Außen-Drehhalter	15
TCLNR/L ..	Internal Tool Holders	Außen-Drehhalter	77
TCLNR/L .. -H	External Turning Toolholders With Coolant Tools	Außen-Drehhalter INNENKÜHLUNG	15
TCMNN ..	External Tool Holders	Außen-Drehhalter	16
TCZNN ..	External Tool Holders	Außen-Drehhalter	16
TDHNR/L ..	External Tool Holders	Außen-Drehhalter	17
TDJNR/L ..	External Tool Holders	Außen-Drehhalter	17
TDJNR/L .. -H	External Turning Toolholders With Coolant Tools	Außen-Drehhalter INNENKÜHLUNG	18
TDNNN ..	External Tool Holders	Außen-Drehhalter	18
TDNNN-H	External Turning Toolholders With Coolant Tools	Außen-Drehhalter INNENKÜHLUNG	19
TD-NR/L ..	Internal Tool Holders	Außen-Drehhalter	77
TDQNR/L ..	Internal Tool Holders	Außen-Drehhalter	78
TDUNR/L ..	Internal Tool Holders	Außen-Drehhalter	78
TER/L ..	External Threading Tool Holders	Werkzeughalter für Außengewinde	136
TER/L ..	Sec Tools	Sec Tools	72
TIR/L ..	Internal Threading Tool Holders	Werkzeughalter für Innengewinde	137
TSDNN ..	External Tool Holders	Außen-Drehhalter	19
TSDNN .. -H	External Tool Holders	Außen-Drehhalter	20
TSKNR/L ..	External Tool Holders	Außen-Drehhalter	20
TSKNR/L ..	Internal Tool Holders	Außen-Drehhalter	79

KOD / CODE	AÇIKLAMA / DESCRIPTION	BESCHREIBUNG	S.N. / P.N. SEITE
TSSNR/L ..	External Tool Holders	Außen-Drehhalter	21
TSSNR/L .. -H	External Tool Holders	Außen-Drehhalter	21
TTENN ..	External Tool Holders	Außen-Drehhalter	22
TTGNR/L ..	External Tool Holders	Außen-Drehhalter	22
TTJNR/L ..	External Tool Holders	Außen-Drehhalter	23
TTJNR/L .. -H	External Tool Holders	Außen-Drehhalter	23
TT-NR/L ..	Internal Tool Holders	Außen-Drehhalter	79
TTUNR/L ..	Internal Tool Holders	Außen-Drehhalter	80
TVHNR/L ..	External Tool Holders	Außen-Drehhalter	24
TVJNR/L ..	External Tool Holders	Außen-Drehhalter	24
TVJNR/L ..-H	External Tool Holders	Außen-Drehhalter	25
TVUNR/L ..	Internal Tool Holders	Außen-Drehhalter	80
TVVNN ..	External Tool Holders	Außen-Drehhalter	25
TVVNN .. -H	External Tool Holders	Außen-Drehhalter	26
TWLNR/L ..	External Tool Holders	Außen-Drehhalter	26
TWLNR/L ..	Internal Tool Holders	Außen-Drehhalter	81
TWLNR/L .. -H	External Turning Toolholders With Coolant Tools	Außen-Drehhalter INNENKÜHLUNG	27

AACN-..	Spare Parts	Ersatzteile	380
AADN-..	Spare Parts	Ersatzteile	380
AAL-..	Spare Parts	Ersatzteile	380
AARC-..	Spare Parts	Ersatzteile	380
AASD-..	Spare Parts	Ersatzteile	380
AASE-..	Spare Parts	Ersatzteile	380
AASN-..	Spare Parts	Ersatzteile	380
AATN-..	Spare Parts	Ersatzteile	380
AAV-..	Spare Parts	Ersatzteile	380
AAVN-..	Spare Parts	Ersatzteile	380
AAWN-..	Spare Parts	Ersatzteile	380
AAV-..	Spare Parts	Ersatzteile	386
ABK-..	Spare Parts	Ersatzteile	393
ABKS-..	Spare Parts	Ersatzteile	392
ABPL-..	Spare Parts	Ersatzteile	392
ACK-..	Spare Parts	Ersatzteile	381
ACS-..	Spare Parts	Ersatzteile	391
AEV-..	Spare Parts	Ersatzteile	387
AKS-..	Spare Parts	Ersatzteile	380
AKV-..	Spare Parts	Ersatzteile	382-383-384-385
AKY-..	Spare Parts	Ersatzteile	384
ALA-..	Spare Parts	Ersatzteile	393
ALV-..	Spare Parts	Ersatzteile	385
AMK-..	Spare Parts	Ersatzteile	381
AN-01..	Spare Parts	Ersatzteile	382
AOR-01	Spare Parts	Ersatzteile	392
APL-..	Spare Parts	Ersatzteile	385
APM-..	Spare Parts	Ersatzteile	386
AS-01	Spare Parts	Ersatzteile	391
ATK-..	Spare Parts	Ersatzteile	381
ATKH-..	Spare Parts	Ersatzteile	381
ATS-..	Spare Parts	Ersatzteile	380
AXR-01	Spare Parts	Ersatzteile	392
1008-..	Spare Parts	Ersatzteile	388
1015-..	Spare Parts	Ersatzteile	388
1020-..	Spare Parts	Ersatzteile	389
1108-..	Spare Parts	Ersatzteile	388

KOD / CODE	AÇIKLAMA / DESCRIPTION	BESCHREIBUNG	S.N. / P.N. SEITE
1120-..	Spare Parts	Ersatzteile	389
1204-..	Spare Parts	Ersatzteile	387
1208-..	Spare Parts	Ersatzteile	387
1210-..	Spare Parts	Ersatzteile	387
1215-..	Spare Parts	Ersatzteile	387
1220-..	Spare Parts	Ersatzteile	387
1315-..	Spare Parts	Ersatzteile	388
1415-..	Spare Parts	Ersatzteile	389
1420-..	Spare Parts	Ersatzteile	389
1510-..	Spare Parts	Ersatzteile	388
1515-..	Spare Parts	Ersatzteile	389
1520-..	Spare Parts	Ersatzteile	389
1615-..	Spare Parts	Ersatzteile	389
1620-..	Spare Parts	Ersatzteile	389
1707-..	Spare Parts	Ersatzteile	389
1710-..	Spare Parts	Ersatzteile	389
1720-..	Spare Parts	Ersatzteile	389
1904-..	Spare Parts	Ersatzteile	385
2004-..	Spare Parts	Ersatzteile	385
2306-..	Spare Parts	Ersatzteile	391
2405-..	Spare Parts	Ersatzteile	391
2406-..	Spare Parts	Ersatzteile	391
2407-..	Spare Parts	Ersatzteile	391
2408-..	Spare Parts	Ersatzteile	391
2503-..	Spare Parts	Ersatzteile	391
2504-..	Spare Parts	Ersatzteile	391
2505-..	Spare Parts	Ersatzteile	391
2506-..	Spare Parts	Ersatzteile	391
2508-..	Spare Parts	Ersatzteile	391
2510-..	Spare Parts	Ersatzteile	391
2514-..	Spare Parts	Ersatzteile	391
2525-..	Spare Parts	Ersatzteile	391
2600-..	Spare Parts	Ersatzteile	390
2702-..	Spare Parts	Ersatzteile	390
2703-..	Spare Parts	Ersatzteile	390
2704-..	Spare Parts	Ersatzteile	390
2705-..	Spare Parts	Ersatzteile	390
2715-..	Spare Parts	Ersatzteile	390
2725-..	Spare Parts	Ersatzteile	390
3006-..	Spare Parts	Ersatzteile	388
3007-..	Spare Parts	Ersatzteile	388
3008-..	Spare Parts	Ersatzteile	388
3010-..	Spare Parts	Ersatzteile	388
3015-..	Spare Parts	Ersatzteile	388
3108-..	Spare Parts	Ersatzteile	388
4006-..	Spare Parts	Ersatzteile	388
4008-..	Spare Parts	Ersatzteile	388
4010-..	Spare Parts	Ersatzteile	388
4015-..	Spare Parts	Ersatzteile	388
4020-..	Spare Parts	Ersatzteile	389
4108-..	Spare Parts	Ersatzteile	388
4115-..	Spare Parts	Ersatzteile	389
4420-..	Spare Parts	Ersatzteile	389
4515-..	Spare Parts	Ersatzteile	389
4615-..	Spare Parts	Ersatzteile	389
80-..	Spare Parts	Ersatzteile	393
81-..	Spare Parts	Ersatzteile	396





**konusulan**  
**the spoken kalite...**  
**quality...**



[www.akko.com.tr](http://www.akko.com.tr)

**konusulan**  
the spoken **kalite...**  
quality...







Konya 5. Organize Sanayi Bölgesi  
Aşağıpınarbaşı Osb Mh. 526 Nolu Sk. No:1  
Selçuklu / KONYA / TÜRKİYE

Tel : +90 332 239 17 57 (pbx)  
Fax : +90 332 239 17 52  
GPS: 38°00'22.1"N 32°38'14.4"E

www.akko.com.tr  
akko@akko.com.tr  
export@akko.com.tr



    AKKO Metalworking Tools

Yenilikler için bizi takip edin!  
Follow us for news!  
Für Neuheiten bitte uns folgen